

ECMA

EUROPEAN COMPUTER MANUFACTURERS ASSOCIATION

STANDARD ECMA-136

- ERGONOMICS -

**REQUIREMENTS FOR NON-CRT
VISUAL DISPLAY UNITS**

June 1989

Free copies of this document are available from ECMA,
European Computer Manufacturers Association
114 Rue du Rhône - CH-1204 Geneva (Switzerland)

Phone: +41 22 735 36 34 Fax: +41 22 786 52 31

ECMA

EUROPEAN COMPUTER MANUFACTURERS ASSOCIATION

STANDARD ECMA-136

- ERGONOMICS -

**REQUIREMENTS FOR NON-CRT
VISUAL DISPLAY UNITS**

June 1989

BRIEF HISTORY

ECMA published in March 1985 Technical Report ECMA TR/22 which gives general ergonomic recommendations for work places with a visual display unit (VDU). These recommendations address not only the characteristics of the (VDU) but also other aspects such as the geometry of work places, arrangements, lighting, noise and ambient conditions. Most of these aspects, as well as the social, organizational and motivational characteristics of the office and business in general are under the control of the user, hence the issue of a Technical Report giving recommendations only.

The requirements for the display unit and the keyboard being entirely under the control of the manufacturers, it was decided to issue ECMA standards specifying mandatory requirements, and including an Appendix specifying methods of measurement of the parameters specified, with the exception of flicker and glare for the reasons indicated in the standards. Standard ECMA-110, published in December 1985, is applicable to monochromatic visual display units and Standard ECMA-126, published in December 1987, is applicable to colour visual display units. These two standards are directed at VDUs of cathode ray tube (CRT) technology.

The present Standard specifies the corresponding requirements for colour visual display units based on non-CRT technologies.

Health aspects of visual displays in general are analyzed in Technical Report ECMA TR/33.

Adopted as an ECMA Standard by the General Assembly of ECMA of 29th June 1989.

Table of Contents

	Page
1. SCOPE	1
2. FIELD OF APPLICATION	1
3. CONFORMANCE	1
4. REFERENCES	1
5. DEFINITIONS	2
5.1 Active Screen Area	2
5.2 Colour	2
5.3 Contrast	2
5.4 Fill Factor	3
5.5 Glare	3
5.6 Illuminance	3
5.7 Luminance	3
5.8 Luminous Flux	3
5.9 Luminous Intensity	3
5.10 Picture Element	3
5.11 Primary Colours	3
5.12 Polarity of the Image Presentation	3
5.13 Reflectance	3
5.14 Viewing Cone	4
6. REQUIREMENTS FOR VDUS	4
6.1 Work Equipment	4
6.1.1 Characteristics of VDU-housing	4
6.1.2 Keyboard characteristics	5
6.2 Characteristics of the Displayed Image	6
6.2.1 Luminance and contrast	6
6.2.2 Polarity	6
6.2.3 Flicker	6
6.2.4 Dynamic Characteristics	7
6.2.5 Glare	7
6.2.6 Character presentation	7
APPENDIX A - METHODS OF MEASUREMENT	9

1. SCOPE

- 1.1 This ECMA Standard specifies requirements for Visual Display Units (VDU) using a non-CRT technology and an associated keyboard input.
- 1.2 This Standard applies specifically to VDUs used intensively in an office by a seated operator for data entry work, data acquisition, interactive communication, or word processing.
- 1.3 The requirements of this Standard are restricted to those physical features of the display unit and keyboard which are entirely under the control of the manufacturer and, as such, are mandatory.
- 1.4 This Standard does not address those ergonomic considerations which are under the control of the user since these can be given only as recommendations. Recommendations for these considerations applicable to office environment are to be found in ECMA TR/22.

2. FIELD OF APPLICATION

The subject of this Standard is those physical characteristics of non-CRT displays and their associated keyboards which ECMA feels are relevant to the comfort and well-being of the operator and are necessary to ensure an efficient interface between the operator and the work station.

However, these characteristics alone are not sufficient to ensure an efficient interface. For those aspects of work station design which are exclusively under the user's control, the reader is referred to Technical Report ECMA TR/22 which is complementary to this document.

3. CONFORMANCE

A non-CRT visual display unit and its associated keyboard shall be in conformance with this Standard if all the requirements herein are met.

The VDU shall also comply with the requirements of Standard ECMA-129.

The VDU shall conform to the limit of acoustical noise prescribed at its location of use. The sound power output of the VDU shall be measured according to Standards ECMA-74 and ECMA-108.

Conformance with this ECMA Standard does not necessarily ensure compliance with all national requirements at the location of use.

4. REFERENCES

- | | |
|----------|--|
| ECMA-74 | Measurement of Airborne Noise Emitted by Computers and Business Equipment |
| ECMA-108 | Measurement of High Frequency Noise Emitted by Computer and Business Equipment |

ECMA-110	Ergonomics - Requirements for Visual Monochromatic Display Devices
ECMA-126	Ergonomics - Requirements for Colour Visual Display Devices
ECMA-129	Safety of Information Technology Equipment (SITE)
ECMA/TR22	Recommendations for VDU Work Places
ECMA/TR33	Visual Displays - Health Aspects
ISO 2813	Paints and Varnishes - Measurements of specular gloss of non-metallic paint films at 20°, 60° and 85°
CIE 17	International Lighting Vocabulary, 3rd Ed.

5. DEFINITIONS

For the purpose of this Standard, the following definitions apply.

5.1 Active Screen Area

That area of the screen within which a picture element may occur.

5.2 Colour

Aspects of visible radiation by which an observer may distinguish differences between two fields of the same size, shape and structure, such as may be caused by differences in the spectral composition of the radiation concerned in the observation.

5.3 Contrast

The difference between two compared stimuli. This term is used both in a subjective and an objective sense.

i) Subjective sense

The difference in appearance of two parts of a field of view seen simultaneously or successively.

ii) Objective sense

The difference in luminance levels between the viewed image and its background expressed as the contrast ratio:

$$C = \frac{L_h}{L_l}$$

where:

L_h = higher luminance

L_l = lower luminance

5.4 Fill Factor

The ratio, expressed in percent, of the active part of a picture element area over the total picture element area.

5.5 Glare

The discomfort or impairment of vision experienced when parts of the visual field are excessively bright in relation to the brightness of the general surroundings.

5.6 Illuminance

The illuminance at a point of a surface is the luminous flux incident on an element of the surface, divided by the area of that element. The unit of illuminance is the lux ($1 \text{ lx} = 1 \text{ lm/m}^2$).

5.7 Luminance

The luminance, at a point of a surface and in a given direction, is the luminous intensity of an element of the surface divided by the area of the orthogonal projection of this element on a plane perpendicular to the given direction. The unit of luminance is the candela per square metre (cd/m^2).

5.8 Luminous Flux

The luminous flux $d\Phi$ of a source of luminous intensity I in an element of solid angle Ω is $d\Phi = I d\Omega$. The unit of luminous flux is the lumen ($1 \text{ lm} = 1 \text{ cd} \times \text{sr}$).

5.9 Luminous Intensity

The candela (cd) is the luminous intensity in a given direction of a source which emits monochromatic radiation of frequency 540×10^{12} Hz and of which the radiant intensity in that direction is 1/683 watt per steradian.

5.10 Picture Element

The smallest portion of the screen addressable by the system.

5.11 Primary Colours

A set of three colours that used alone or in suitable mix reproduce a range of colour stimuli.

5.12 Polarity of the Image Presentation

i) Negative polarity

Light or illuminated characters presented on a darker or unilluminated background.

ii) Positive polarity

Dark or unilluminated characters presented on a lighter or illuminated background.

5.13 Reflectance

The ratio ρ of the luminous flux reflected from a surface to the luminous flux incident on it. Reflectance may be specular or diffuse.

5.14 Viewing Cone

A cone the apex of which is located on a picture element, which has an angle of 45° and its axis perpendicular to the display surface.

6. REQUIREMENTS FOR VDUs

6.1 Work Equipment

6.1.1 Characteristics of VDU-housing

6.1.1.1 Adjustability

Keyboards of table-top units, if fitted to the workstation, shall be separable from the screen by a distance of at least 300 mm (Fig. 1).

The inclination of the surface of the screen shall be adjustable at least between -3° and $+15^\circ$ from the vertical (Fig. 1).

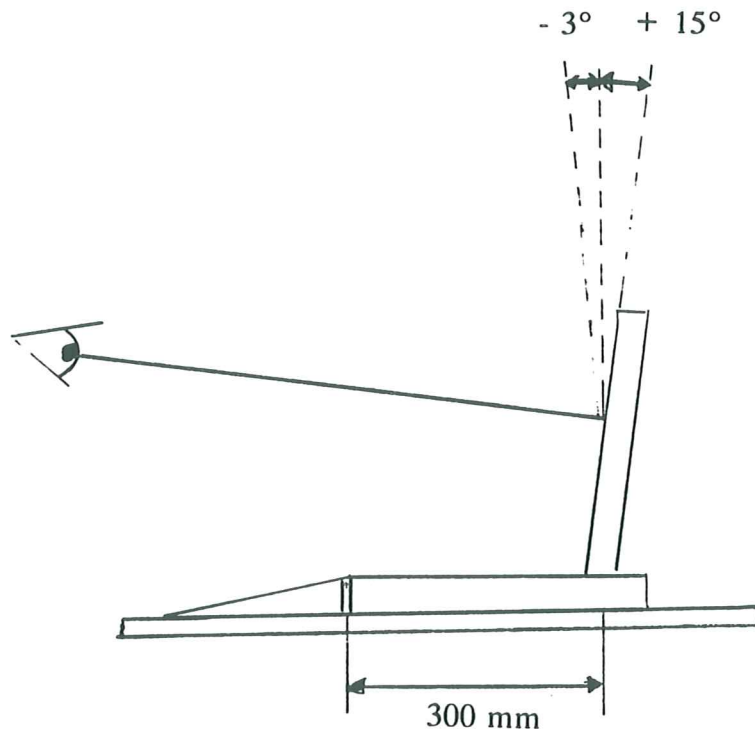

Figure 1 - Tilt Angle

6.1.1.2 Surface glare

The specular reflectance of surfaces shall not exceed 45 gloss units (silky matt) (see A.3). The diffuse reflection factor for the front frame of the VDU screen shall be between 0,15 and 0,75. See A.2.

6.1.2 Keyboard characteristics

6.1.2.1 Dimensions

The keyboard slope shall be in the range 5° to 18° (Fig. 2). Adjustability is not mandatory. See A.4.

A keyboard shall not be higher than 35 mm measured from the work surface to the centre of a key top at the C-row (Fig. 3 and 4) with the keyboard in its lowest position of angular adjustment.

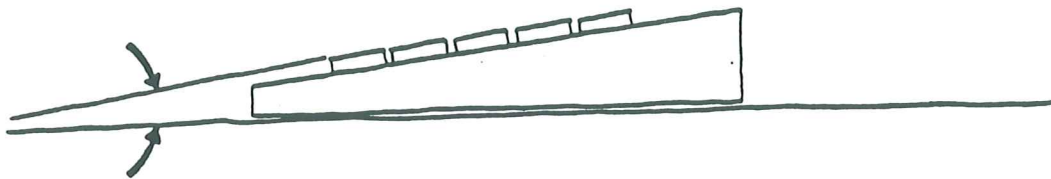

Figure 2 - Keyboard Slope

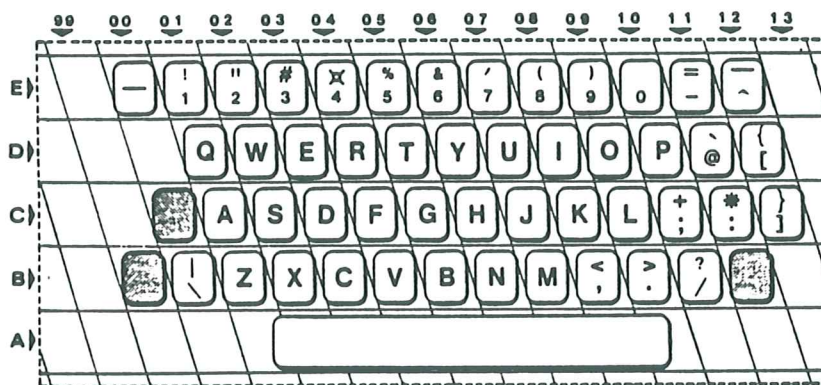

Figure 3 - Keyboard Rows

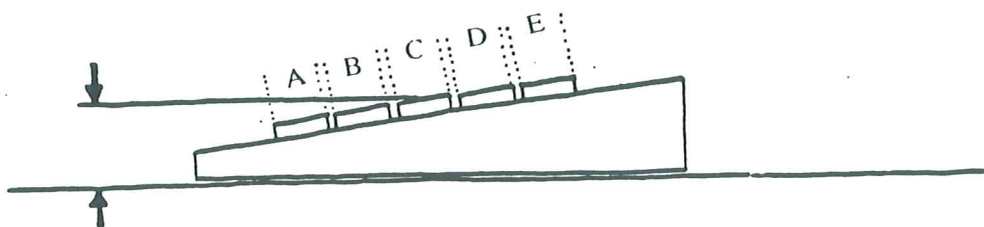

Figure 4 - Keyboard Height

6.1.2.2 Geometry and layout of keytops

The key top (the portion of the key touched by the operator) shall be concave.

The area of the key top shall be at least 113 mm^2 , the minimum dimension being 12 mm.

The horizontal distance between keys measured centre-to-centre shall be $19 \text{ mm} \pm 1 \text{ mm}$ for the alphanumeric keys and separate numerical key pad, if provided.

6.1.2.3 Key characteristics

The keys shall have a travel between 1 mm and 8 mm.

The maximum key force shall be between 0,25 N and 1,50 N with a preferred force between 0,50 and 0,60 N. The force for alphanumeric keys shall be within $\pm 25\%$ of the average force.

Feedback shall be provided in one of the following ways (or in any combination of them):

- a "stop" at some distance after electrical contact has been made,
- a "trigger" point in the depression movement past which the force ceases to increase,
- an audible click.

N key roll-over shall be provided, where $N = 3$ or more. The N key roll-over should be consistent and applies to all alphanumeric keys.

The burst rate capability shall be at least 50 characters per second for at least 3 seconds. During the burst the keys shall be recognized in the sequence of their action.

If the repeat rate of selected keys is fixed, then the repeat rate shall be (15 ± 5) characters per second after at least 0,5 s. An adjustable repeat rate is preferred.

Surface

The surface of the keys and keyboard shall have the specular and diffuse reflectance values specified in 6.1.1.2. See A.2 and A.3.

Major symbols on the key tops shall have a contrast ratio of at least 3:1 with the surface of the key top and shall be at least 2,6 mm high.

6.2 Characteristics of the Displayed Image

6.2.1 Luminance and contrast

Within the reference environment the higher luminance level shall be at least $35 \text{ cd} / \text{m}^2$ and the contrast ratio shall be at least 3 : 1.

Note 1

It is desirable that the contrast ratio be adjustable under user control.

6.2.2 Polarity

Either polarity is acceptable.

6.2.3 Flicker

Visual display units shall be designed so as not to flicker, i.e. any periodic light variation shall not be perceived.

Note 2

This clause is part of the standard because it is essential that VDUs should be flicker-free. However, for the time being no objective conformance test can be specified, as scientific investigations presently in progress have not allowed a reliable test method to be identified.

6.2.4 Dynamic Characteristics

The effects of dynamic characteristics, such as rise and fall time of the luminance, are application-dependent. Therefore, ECMA does not consider a general conformance requirement to be appropriate for inclusion in this Standard.

6.2.5 Glare

Specular glare is a function of the sharpness and maximum luminance of a reflected image. Specular glare should be minimized.

Note 3

The design/manufacturing methods for reducing glare (if appropriate) include etched surfaces, optical coatings, micromesh filters, polarizers, hoods, etc. These methods are application dependent and, as such, ECMA does not consider a conformance requirement to be appropriate for inclusion in this Standard.

Attention is drawn to TR/22 Clause 7.4 for user methods of reducing glare.

6.2.6 Character presentation

6.2.6.1 Character height/dot matrix

A character matrix consisting of seven picture elements in the vertical direction and five picture elements in the horizontal direction shall be the minimum to be used for digits and capital letters.

The height shall be increased upward by at least two picture element positions if diacritical marks are to be used. When displaying small letters, the height shall be increased downward by at least two picture element positions to accommodate the descenders of the small letters. The minimum height of a capital letter shall be 2,9 mm regardless of screen size and picture element matrix. See A.7.

6.2.6.2 Character and stroke width proportions

The character width shall be between 50% and 80% of the character height. See A.7.

The stroke width shall be between 8% and 20% of the character height. See A.7.

6.2.6.3 Character spacing

For dot matrix displays, the character spacing for non-proportionally spaced fonts in either direction shall be at least one row or column of picture elements.

6.2.6.4 Distortion

6.2.6.4.1 Luminance variation

The variation in luminance shall be assessed by measuring the luminance at five points (centre and four corners), see A.8.1. The ratio of the maximum luminance $L_{ha \text{ max}}$ to the minimum luminance $L_{ha \text{ min}}$ shall not be greater than 2,0. However, a maximum value of 1,5 is recommended.

6.2.6.4.2 Geometric variation of the screen

Distortions of lines and columns shall be minimized. Non-linearity of any column or row shall not exceed 2,0% of the length of the column or row.

6.2.6.4.3 Character size variation

The height and width of a character shall not differ by more than 10,0% from the average height and width of all characters. This variation shall be measured as specified in A.8.3 at five character positions, viz. at the centre and the four corners of the screen.

6.2.6.4.4 Character stability

Location changes of a character in the frequency range between 0,1 Hz and 30 Hz shall not be greater than 0,10 mm in either the horizontal or the vertical direction, see A.8.4.

6.2.6.5 Colour uniformity

Within the viewing cone, positioned anywhere on the screen, there shall be no noticeable difference in any given colour.

Note 4

This requirement is part of the Standard because it is essential that VDUs present uniform colours. However, for the time being, no objective conformance test can be specified, as scientific investigations have not yet produced a reliable criterion.

APPENDIX A

METHODS OF MEASUREMENT

The methods of measurement specified in this Appendix shall be used for checking conformance to the clauses of this Standard. They are applicable to VDUs both with positive and negative polarity. Simplified methods have been specified with the aim of avoiding expensive and time-consuming measurements.

All measurements and evaluations shall be carried out in the test environment.

A.1 Test Environment

The conditions for testing shall be as follows.

Temperature : 23°C ± 2°C

Relative Humidity : 40% to 50%

Illuminance : 250 lx perpendicular to the screen at the measurement point (see A.6)

Care should be taken to avoid specular reflections in the area of the screen under test.

A.2 Diffuse Reflection Factor

The diffuse reflection factor of opaque surfaces can easily be judged by means of a diffuse reflection factor chart.

Note A.2

Such charts are commercially available, for example from:

Verlag W. Girardet

D-4300 ESSEN

Germany

Part Number: 0725

From Handbuch für Beleuchtung (ISBN: 3-7736-0725-3)

A.3 Specular Reflectance

The specular reflectance of external surfaces, including key-caps, but excluding the VDU screen, shall be measured by means of a 60° glossmeter calibrated against a Reference Glass Mirror, according to International Standard ISO 2813.

The surfaces meeting the characteristics (planarity and dimensions) needed for proper operation of the instrument chosen shall be measured directly. In the case of surfaces too small and/or too curved (e.g. keycaps) the measurement shall be performed on a sample surface of suitable planarity, dimensions and surface treatment.

A.4 Keyboard Slope

The slope of the keyboard shall be measured as the angle between the horizontal plane and a line drawn through the centres of key rows B and D.

A.5 Luminance

The luminance of character and background (either with positive or negative polarity) for the purpose of 6.2.1 shall be measured in terms of mean value (mean luminance).

A.5.1 Higher luminance level (L_{ha})

The higher luminance level represents either the mean background luminance in case of positive polarity or the mean character luminance in case of negative polarity.

The measurement of the higher luminance level L_{ha} for the purpose of 6.2.1 shall be made by means of a narrow-angle luminance probe. A full matrix (i.e. a cursor) of at least 5 x 5 picture elements shall be activated in the brightest available white or colour at the measurement point as shown in Fig. A.1.

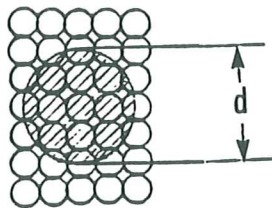

Figure A.1

The diameter d of the circular area "seen" by the luminance probe shall be contained within the full matrix, but it shall completely cover a block of at least 3 x 3 picture elements. The maximum diameter d shall be 10 mm. This is achievable by setting the proper distance from the probe to the surface of the screen, taking into account the visual angle of the probe itself.

In case of positive polarity, the result will be the background luminance L_b .

In case of negative polarity, the result will be assumed to be the luminance L_c of the character.

A.5.2 Lower luminance level (L_{la})

The lower luminance level represents either the mean character luminance in case of positive polarity, or the mean background luminance in case of negative polarity.

The measurement of the lower luminance level L_{la} shall be made when measuring the lower luminance level in the presence of ambient illuminance. Attention shall be paid:

- to avoid shading the measured area with the luminance probe,
- to avoid effects of specular reflections.

A.5.3 Contrast

Higher luminance level for the purpose of calculating contrast (Cr) shall be measured in the presence of ambient illumination as specified in A.1, using the narrow-angle luminance probe and with the illuminance probe removed. The contrast ratio Cr shall be:

$$Cr = \frac{L_{ha}}{L_{la}}$$

A.6 Ambient Illuminance

The ambient illuminance on the screen shall be measured by means of a flat luxmeter probe, applied to the surface itself, so as to reduce errors due to the thickness of the head.

The ambient illuminance shall be measured perpendicularly to the screen surface (see Figure A.2). For this purpose, controlled illuminance shall be obtained by diffuse indirect lighting, avoiding specular reflections.

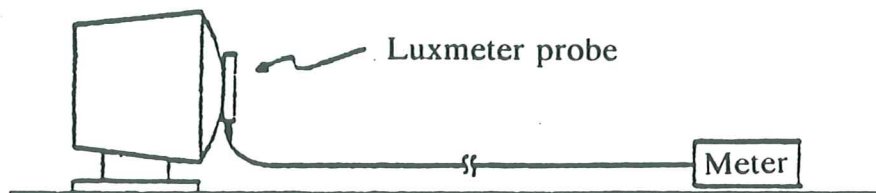

Figure A.2

A.7 Character Dimensions

Character dimensions shall be measured from edge to edge. The higher luminance level shall be set as in A.5.1. The evaluation shall be made on capital letter H or E, which involve all the external rows and columns of the matrix, and activated in the brightest available white or colour. The edges of the character and the stroke shall be evaluated according to Fig. A.3 for both positive and negative polarity.

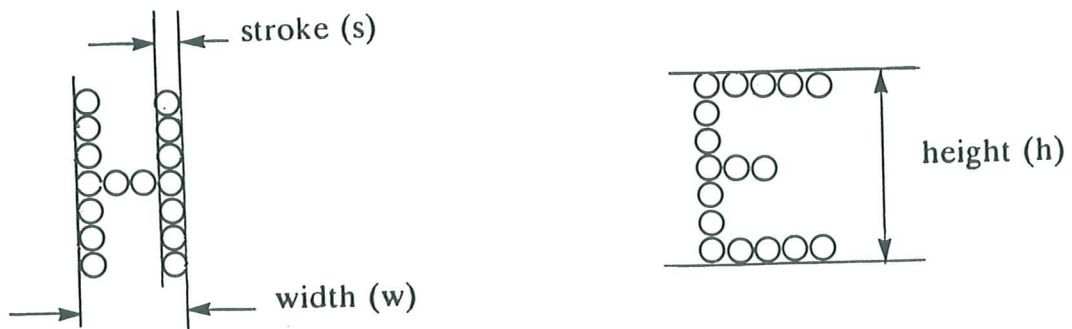

Figure A.3

The present method applies to Clauses 6.2.6.1, and 6.2.6.4.3.

A.8 Distortion

A.8.1 Luminance variation

The higher luminance level shall be measured according to A.5.1 on a full matrix (i.e. a block cursor) activated at the centre and the corners of the screen in the brightest available white or colour (see Fig. A.4). The optical axis of the luminance probe shall be perpendicular to the screen surface at the point of measurement.

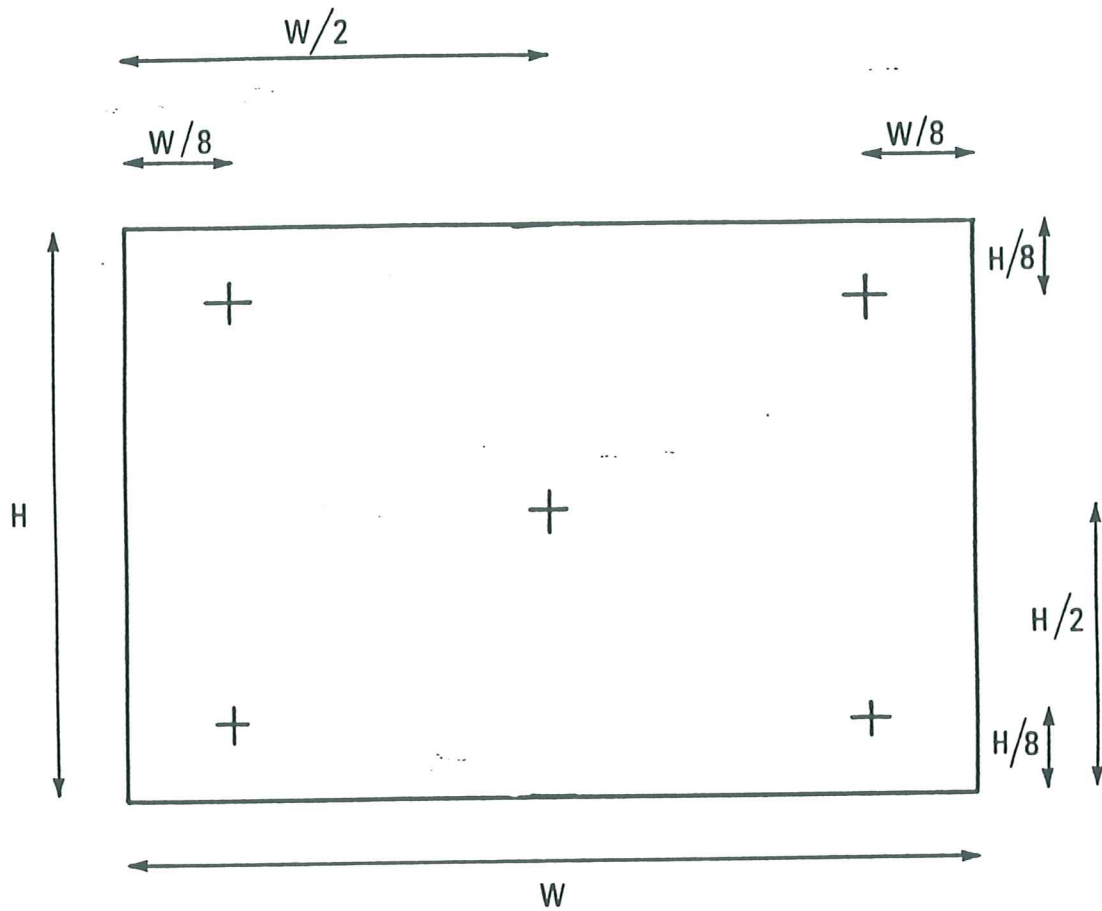

Figure A.4

- H = total height of the active area of the screen
- W = total width of the active area of the screen
- + = measurement point

A.8.2 Geometric variations of the screen

The non-linearity of rows and columns may be judged by means of a transparent mask with reference lines held against the screen and viewed in a direction perpendicular to the screen. Dimensions and tolerances shall comply with 6.2.6.4.2.

A.8.3 Character size variation

These measured heights and widths shall be compared with the averaged height h and the averaged width w calculated as follows:

$$h = \frac{n}{N} \cdot H$$

$$w = \frac{m}{M} \cdot W$$

where:

- H : total height of the active area of the screen
- W : total width of the active area of the screen
- n : number of element lines in the character
- m : number of element columns in the character
- N : total number of element lines in the active area
- M : total number of element columns in the active area

The present method applies to 6.2.6.4.3.

A.8.4 Character stability

Changes of character position in any direction shall be measured in terms of picture element movement, according to Figure A.5.

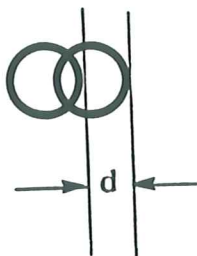

Between dot edges

Figure A.5

The measurement shall be made at the centre and at the corners of the screen (See Fig. A.4). The present method applies to 6.2.6.4.4.

