

ECMA

Standardizing Information and Communication Systems

**Private Integrated Services Network
(PISN) –
Circuit Mode 64kbit/s Bearer Services –
Service Description, Functional
Capabilities and Information Flows**

ECMA

Standardizing Information and Communication Systems

**Private Integrated Services Network
(PISN) –
Circuit Mode 64kbit/s Bearer Services –
Service Description, Functional
Capabilities and Information Flows**

(BCSD)

Brief History

This Standard is one of a series of ECMA Standards defining services and signalling protocols applicable to Private Integrated Services Networks (PISNs). The series uses ISDN concepts as developed by ITU-T and conforms to the framework of International Standards for Open Systems Interconnection as defined by ISO/IEC. It has been produced under ITSTC work item M-IT-05 2.1.2.1 and under ETSI work item RE/ECMA-00136.

This particular Standard contains specifications of basic services.

This Standard is based upon the practical experience of ECMA member companies and the results of their active and continuous participation in the work of ISO/IEC JTC1, ITU-T, ETSI and other international and national standardization bodies. It represents a pragmatic and widely based consensus.

Compared to the 1st Edition of Standard ECMA-142 (published by ECMA in June 1990), this 2nd Edition has been restructured, and changes have been incorporated, in order to achieve complete alignment with International Standard ISO/IEC 11574:1994(E) and ISO/IEC 11574 Amendment 1 (1997). It also includes European additions identified in ETS 300 171 2nd Edition.

Differences between this ECMA Standard and the ISO/IEC International Standard with which it is aligned are clearly identified.

Table of contents

	Page
Section 1: General	1
1 Scope	1
2 References (normative)	1
2.1 International Standards	1
2.2 ITU-T Recommendations	2
3 Definitions	2
3.1 call	2
3.2 intervening network (IVN)	2
3.3 mixed public/private ISDN	2
3.4 network call control entity	2
3.5 Private Integrated Services Network (PISN)	2
3.6 Private Integrated Services Network Exchange (PINX)	2
3.7 PISN user	2
3.8 service [Telecommunication services]	3
3.9 user	3
4 Symbols and abbreviations	3
5 Provision of services by a PISN	4
5.1 Bearer services	4
5.2 Teleservices	4
5.3 Control and signalling	4
5.4 Interworking considerations	5
5.5 Service model	5
Section 2: Service Description (stage 1 description)	6
6 Circuit-mode 64 kbit/s unrestricted 8 kHz structured bearer service category	6
6.1 Definition	6
6.2 Description	6
6.3 Procedures	6
6.4 Network capability for charging	6
6.5 Interworking considerations	6
6.5.1 Interworking with a public ISDN and certain other digital networks	6
6.5.2 Interworking with networks supporting only a restricted digital information transfer capability	7
6.5.3 Interworking with analogue networks	7
6.6 Static Description: Service Attributes	7
7 Circuit-mode 64 kbit/s 8 kHz structured bearer service category usable for speech information transfer	8

7.1 Definition	8
7.2 Description	8
7.3 Procedures	8
7.4 Network capability for charging	8
7.5 Interworking considerations	8
7.5.1 Interworking with a public ISDN and certain other digital networks	8
7.5.2 Interworking with analogue networks	8
7.5.3 Encoding law conversion	9
7.6 Static Description: Service Attributes	9
8 Circuit-mode 64 kbit/s 8 kHz structured bearer service category usable for 3,1 kHz audio information transfer	9
8.1 Definition	9
8.2 Description	10
8.3 Procedures	10
8.4 Network capability for charging	10
8.5 Interworking considerations	10
8.5.1 Interworking with a public ISDN and certain other digital networks	10
8.5.2 Interworking with analogue networks	10
8.5.3 Encoding law conversion	10
8.6 Static Description: Service Attributes	10
9 Common procedures for services within a PISN	11
9.1 Provision of services	11
9.2 Normal procedures	11
9.2.1 Call establishment at the calling PISN user	11
9.2.2 Call establishment at the called PISN user	12
9.2.3 Terminating the service (call release)	13
9.3 Exceptional procedures / unsuccessful outcome	13
10 Interworking	14
10.1 General Interworking considerations	14
10.1.1 Incoming calls	14
10.1.2 Outgoing calls	15
10.1.3 PISN transit calls	15
10.2 Interworking with public-ISDN	15
10.2.1 Receipt of service request from a public ISDN	15
10.2.2 Sending a service request to a public ISDN	16
10.2.3 Receipt of a service response from public ISDN	16
10.2.4 Sending service response to public ISDN	16
11 Dynamic Description	16
Section 3: Functional capabilities and information flows (stage 2 description)	20
12 Functional model	20

12.1 Functional model description	20
12.2 Description of the functional entities	20
12.2.1 Call Control Agent functional entity	21
12.2.2 Call Control functional entity	21
13 Definition of information flows	23
13.1 Conventions used within the description of information flows	23
13.1.1 Convention for the description of mandatory or optional information	23
13.1.2 Convention for the naming of information flows	23
13.2 SETUP	24
13.3 REPORT	28
13.4 CHANNEL_ACKNOWLEDGE	29
13.5 CHANNEL_CONNECT	29
13.6 DISCONNECT	29
13.7 RELEASE	30
13.8 INFORMATION	30
13.9 SETUP_REJECT	30
13.10 PROCEEDING	31
14 Information flow sequences	31
14.1 Functional entity actions	31
14.1.1 Originating CCA functional entity	31
14.1.2 Originating CC functional entity	32
14.1.3 Transit CC functional entity	33
14.1.4 Destination CC functional entity	34
14.1.5 Destination CCA functional entity	36
14.1.6 Incoming gateway CC functional entity	36
14.1.7 Outgoing gateway CC functional entity	38
14.2 Normal call establishment	40
14.3 Normal call establishment with digit-by-digit sending and automatic answer	41
14.4 Unsuccessful calls with the provision of tones and announcements	42
14.5 Unsuccessful calls without the provision of tones and announcements	43
14.6 Incoming interworking with a non-ISDN	44
14.7 Outgoing interworking with a non-ISDN	45
14.8 Outgoing interworking with digit-by-digit sending	46
14.9 Basic call clearing	47
14.10 Incoming interworking with a public ISDN	48
14.11 Outgoing interworking with a public ISDN	49
15 SDL diagrams for functional entities	50
15.1 Originating CCA functional entity SDL diagrams	50
15.1.1 Originating CCA states used in SDL diagrams	50
15.1.2 Originating CCA SDL diagrams	51
15.2 Originating CC functional entity SDL diagrams	55
15.2.1 Originating CC states used in SDL diagrams	55

15.2.2 Originating CC SDL diagrams	56
15.3 Transit CC functional entity SDL diagrams	63
15.3.1 Transit CC states used in SDL diagrams	63
15.3.2 Transit CC SDL diagrams	64
15.4 Destination CC functional entity SDL diagrams	69
15.4.1 Destination CC states used in SDL diagrams	69
15.4.2 Destination CC SDL diagrams	70
15.5 Destination CCA functional entity SDL diagrams	77
15.5.1 Destination CCA states used in SDL diagrams	77
15.5.2 Destination CCA SDL diagrams	77
16 Allocation of functional entities to physical entities	81
Annex A - Service attributes	83
Annex B - Teleservices	85
Annex C - Bibliography	89
Annex D - Errors in ISO/IEC 11574	91

Section 1: General

1 Scope

This Standard specifies the service description and control aspects, including functional capabilities and information flows, of standardised circuit-mode bearer services which may be supported by a Private Integrated Services Network (PISN).

This Standard includes the following basic services:

- Circuit-mode 64 kbit/s unrestricted 8 kHz structured bearer service category;
- Circuit-mode 64 kbit/s 8 kHz structured bearer service category usable for speech information transfer;
- Circuit-mode 64 kbit/s 8 kHz structured bearer service category usable for 3,1 kHz audio information transfer.

A PISN shall support at least one of the above three bearer services to conform with this Standard.

The scope of this Standard does not include:

- the negotiation of service at call establishment time,
- the change of service during a call, and
- unidirectional services.

This Standard includes optional procedures for the provision of functions equivalent to the following public ISDN supplementary services: Subaddress and Multiple Subscriber Number.

NOTES

1. *Supplementary services and other bearer services which can be used in conjunction with 64 kbit/s circuit switched bearer services specified in this Standard are dealt with in other standards.*
2. *Service specifications are based on information concerning the corresponding public ISDN service available at the time of publication of this Standard.*
3. *ITU-T treat Subaddressing and Multiple Subscriber Number as supplementary services.*
4. *The use of the Direct Dial In supplementary service of a public ISDN for calls incoming to a PISN from a public ISDN is regarded as part of the basic services in a PISN.*
5. *The use of the Calling Line Identification Presentation and Connected Line Identification Presentation supplementary services of a public ISDN for obtaining the Originating Number or the Connected Number of a call from or to a public ISDN is regarded as part of the basic services in a PISN.*
6. *The provision (either explicitly or implicitly) by the user to the network, of its own number (Originating Number or Connected Number), and the provision of an Originating Number or a Connected Number by a PISN to another network is a part of the basic services in a PISN and not a part of the Calling Line Identification Presentation and Connected Line Identification Presentation supplementary services. Those supplementary services are concerned only with the presentation of the number from the network to the served PISN user.*

2 References (normative)

The following standards contain provisions which, through reference in this text, constitute provisions of this Standard. All standards are subject to revision, and parties to agreements based on this Standard are encouraged to investigate the possibility of applying the most recent editions of the standards indicated below.

2.1 International Standards

- | | |
|-----------------|--|
| ISO/IEC 11571 | Information technology - Telecommunications and information exchange between systems - Numbering and sub-addressing in private integrated services networks |
| ISO/IEC 11579-1 | Information technology - Telecommunications and information exchange between systems - Private Integrated Services Network - Part 1: Reference configuration for PISN Exchanges (PINX) |

2.2 ITU-T Recommendations

- Recommendation G.711 Primary PCM multiplex equipment for voice frequencies (1992)
- Recommendation I.112 Vocabulary of terms for ISDNs (1992)
- Recommendation I.140 Attribute technique for the characterisation of telecommunications services supported by an ISDN and network capabilities of an ISDN (1992)
- Recommendation I.210 Principles of telecommunications services supported by an ISDN and the means to describe them (1992)
- Recommendation I.231 Circuit-mode bearer service categories (1992)
- Recommendation I.251.1 Number Identification Supplementary Services – Direct Dialling-In (1992)
- Recommendation I.251.3 Number Identification Supplementary Services – Calling Line Identification Presentation (1992)
- Recommendation I.251.5 Number Identification Supplementary Services – Connected Line Identification Presentation (COLP) (1992)
- Recommendation I.520 General arrangements for network interworking between ISDNs (1992)
- Recommendation X.31 Support of packet-mode terminal equipment by an ISDN (1992)

3 Definitions

For the purpose of this Standard, the following definitions apply. For other terms used in this Standard, the definitions in ISO/IEC 11579-1 and ITU-T Rec. I.112 apply.

3.1 call

The instance of the use of a service.

3.2 intervening network (IVN)

The generic term for any real type of network which is employed for the provision of inter-PINX connections.

3.3 mixed public/private ISDN

An overall ISDN which consists of any concatenation of public/private networks.

NOTE 7

Services are transparent to the users across public and private network components of a mixed public/private network.

3.4 network call control entity

The collection of network functions concerned with the control of services, as opposed to functions concerned with the transfer of user information.

3.5 Private Integrated Services Network (PISN)

A private network providing services to a specific set of users.

NOTES

8. *Contrary to a Public ISDN which provides services to the general public.*

9. *The term PISN covers more than a private ISDN.*

3.6 Private Integrated Services Network Exchange (PINX)

A PISN nodal entity which provides automatic connection handling functions used for the provision of telecommunication services. A nodal entity may consist of one or more nodes.

3.7 PISN user

An entity which uses telecommunication services offered by a PISN, and which therefore directly or indirectly uses the services of the Network Layer.

3.8 service [Telecommunication services]

That which is offered by a PISN operator and/or owner to its customers in order to satisfy a specific telecommunication requirement.

Unless otherwise stated, the term “service” shall mean “bearer [telecommunication] service”.

3.9 user

An entity which uses telecommunication services offered by a network, and which therefore directly or indirectly uses the services of the Network Layer.

4 Symbols and abbreviations

CC	Clearing Cause
CC [FE]	Call Control generic functional entity
CCA	Call Control Agent generic functional entity
cfm c	confirmation
CH	Call History
CI	Channel Identifier
CN	Connected Number
CS	Connected Subaddress
CT	Connection Type
DN	Destination Number
DS	Destination Subaddress
FE	Functional Entity
HLC	High Layer Compatibility
ind i	indication
ISDN	Integrated Services Digital Network
ISO	International Organisation for Standardisation
LLC	Low Layer Compatibility
NC	Number complete indication
ON	Originating Number
OS	Originating Subaddress
OSI	Open Systems Interconnection
PINX	Private Integrated Services Network Exchange
PISN	Private Integrated Services Network
PSTN	Public Switched Telephone Network
Rec.	(ITU-T) Recommendation
req rq	request
resp rs	response
RT	Report Type
SDL	Specification and Description Language
TE	Terminal Equipment

5 Provision of services by a PISN

Basic services within a PISN consist of bearer services and teleservices. A bearer service is defined only up to a certain layer, in any case no higher than Layer 3. The definition of a teleservice also encompasses the higher layers up to Layer 7 (although some of the layers can be empty or not specified, as with for example, Telephony).

The basic services defined in this Standard correspond to the 64 kbit/s circuit-mode basic services defined in ITU-T Recommendation I.231.

5.1 Bearer services

PISN circuit-mode bearer services provide a means of transferring information between users at the physical layer level. Service attributes above Layer 3 are not defined. Consequently, the provision of bearer services involves only low layer functions. A bearer service can support a variety of high layer protocols.

A circuit-mode bearer service provides an end to end connection (at the physical layer) for the conveyance of user information. Each switching point intervenes only at the physical layer. This gives a constant bit rate and fixed delays which are very close to the inherent delays of the transmission media.

5.2 Teleservices

The provision of a teleservice involves high layer functions, generally using the underlying low layer capabilities of a bearer service. A PISN can support a teleservice by supporting a bearer service having the same capabilities as those required by the teleservice and by satisfying any special control requirements of the teleservice. The provision of high layer functions in support of a teleservice is not a necessary part of a PISN and is beyond the scope of this Standard.

When requesting a teleservice from a PISN, the user has to explicitly indicate the bearer capabilities required in the same way as when a bearer service is requested. In addition, an indication of the teleservice required is provided by the PISN user, primarily for passing the indication through the network to the called PISN user in order to allow compatibility checking. A PISN can optionally make use of this information for purposes such as barring certain teleservices to certain PISN users, or for the provision or activation of supplementary services on a per teleservice basis, e.g., call forwarding. Any use of this information by a PISN is outside the scope of, but is not precluded by, this Standard.

Annex B provides guidelines for, and additional information about, teleservices.

Difference from ISO/IEC 11574

The above paragraph is modified from that in ISO/IEC 11574.

The paragraph in the ISO/IEC International Standard is:

"Annex B provides guidelines and additional information which are appropriate for the teleservice, telephony."

End of Difference

5.3 Control and signalling

In order for information transfer to take place, an information connection must exist between the PISN users concerned. A demand service involves the establishment and release of information connections according to the demands of users. From the point of view of users, calls have to be established and released, and this involves call control functions. Call control requires knowledge of the properties of the user information to be transferred in order to provide appropriate capabilities.

In general, more than one network element (e.g., PINX, terminal) is involved in a call, and therefore call control is distributed. Consequently call control information needs to be conveyed between network elements. The conveyance of this information is a function of signalling.

PISN services use message based signalling information, which means that signalling information is carried over a dedicated logical connection, separate from the connection established for conveying user information.

NOTE 10

The possible use of the signalling connection also to provide user-to-user information transfer is the function of the User-to-User Signalling supplementary service, and is outside the scope of this Standard.

5.4 Interworking considerations

In general, interworking between a PISN bearer service and a bearer service provided by another network requires interworking functions, both for information transfer and for signalling.

When interworking with the same service in a public ISDN, the interworking function for information transfer is null. However, interworking has an impact on signalling.

5.5 Service model

This Standard uses the following service model in order to specify services.

The PISN provides bearer capabilities between end users for the support of the bearer service requested by the user to support applications. The PISN user controls the bearer capabilities through the control plane. Coordination between the bearer capabilities and the control plane is maintained by each PINX involved in the connection.

The user terminal interfaces are identified by an address, which in a PISN is defined by a PISN number or a concatenation of a number and a Subaddress.

The control plane processes address information along with other parameters as necessary to effect the necessary routing. This Standard views control functions as services being provided by a Network Call Control entity, which are accessible through control service access points. Coordination functions use the services of the Network Call Control entity when coordinating call control with the transfer of user information, thereby providing bearer capability to PISN users. Unless explicitly stated the terms “network” and “Network Call Control Entity” are used interchangeably. See figure 1.

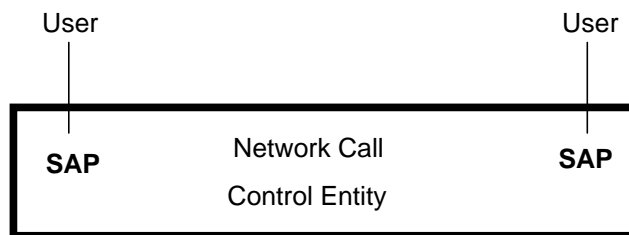

SAP = Service Access Point

Figure 1 – Service model

The primitives used across Network Call Control service access points are as follows.

- SETUP_request / indication / response / confirmation; used for call establishment.
- RELEASE_request / indication / response / confirmation; used for call rejection and release.
- REPORT_request / indication; used for reporting to the calling user:
 - that the call is proceeding,
 - that the called PISN user is being alerted,
 - the presence of in-band tones or announcements, and
 - of interworking situations.
- INFORMATION_request; used for providing additional destination addressing information not provided with the SETUP_request.

In the Stage 1 description, the control aspects of services are specified in terms of the primitives listed above at the Network Call Control service access points. The entire Network Call Control is treated as a single entity.

In the Stage 2 description, the internal behaviour of Network Call Control is specified by breaking it down into a number of Functional Entities (FE) and specifying the information flows between them. The result is a model of the form shown in figure 2. The particular model used for the basic call is specified in section 3 of this Standard. Other models based on this generic model are used for specifying supplementary services. Supplementary services are not specified in this Standard.

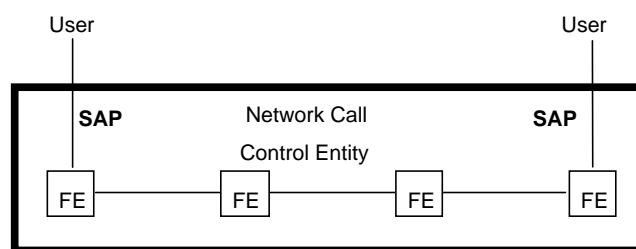

SAP = Service Access Point

Figure 2 – Generic model for Stage 2

Section 2: Service Description (stage 1 description)

6 Circuit-mode 64 kbit/s unrestricted 8 kHz structured bearer service category

6.1 Definition

This bearer service category provides information transfer at 64 kbit/s without alteration between PISN users. The service can support various PISN user applications. Examples include:

- speech (see Note 11);
- 3,1 kHz audio (see Note 11);
- multiple subrate information streams multiplexed into 64 kbit/s by the PISN user;
- transparent access to a public or private X.25 network (ITU-T Rec. X.31 case A for access to a public X.25 network).

NOTE 11

Whilst speech and 3,1 kHz audio have been given as applications for this bearer service, the PISN user should ensure that a compatible encoding scheme is in operation. In any case, no network provision can be made for the control of such items as echo and loss, as the network is unaware of the application in use. Furthermore, the quality of service attribute value for information transfer delay indicates the suitability of a particular version of this bearer service for speech communication.

6.2 Description

This circuit-mode bearer service category allows:

- two PISN users to communicate in a point to point configuration via the network using 64 kbit/s digital signals, in both directions continuously and simultaneously for the duration of a call;
- in conjunction with a conference call supplementary service (the procedures of which are outside the scope of this Standard), three or more PISN users to communicate in a multi-point configuration.

Once the information channel connection has been established according to the procedures described in clauses 9 to 11, it is available for the transmission of 64 kbit/s digital signals in both directions continuously and simultaneously, without alteration by the network. The network shall place no restrictions on the content of the digital signals.

6.3 Procedures

These are common to all services in this Standard and are given in clause 9.

6.4 Network capability for charging

This is outside the scope of this Standard.

6.5 Interworking considerations

6.5.1 Interworking with a public ISDN and certain other digital networks

Services in this category are able to interwork with the same services in a public ISDN. The interworking function for user information transfer is null.

6.5.2 Interworking with networks supporting only a restricted digital information transfer capability

During an interim period, some other networks may only support restricted 64 kbit/s digital information transfer capability, i.e., information transfer capability solely restricted by the requirement that the all-zero octet is not allowed. Interworking can be achieved according to the rules given in Appendix I of ITU-T Rec. I.520 (the PISN being treated as an ISDN with unrestricted 64 kbit/s capability). The PISN shall assume that the interworking functions are provided in the other network. The PISN need not be affected by this interworking, other than by conveying the appropriate signalling indication to and from the user.

6.5.3 Interworking with analogue networks

The PISN may support calls between data terminals and an analogue network. In this case the following procedures apply.

A V-series terminal¹ shall be connected to the PISN via a terminal adaptor. The PISN shall provide an interworking function (including a modem) for calls to or from a user of an analogue network (e.g., PSTNs or private analogue networks). To effect a connection, the PISN should use a 64 kbit/s unrestricted connection between its user and the interworking function, and a 3,1 kHz audio connection (or equivalent) from the interworking unit to the analogue network.

NOTE 12

If additional information concerning layer 1 protocols is available, the PISN may provide the interworking function.

In general, when a call originates in an analogue network, the analogue network is unable to indicate to the PISN the service required. If this is the case, the called PISN user is offered a 3,1 kHz audio bearer service with an indication of such interworking.

NOTE 13

If at the called PISN user there is a terminal adaptor which is unable to accept an incoming 3,1 kHz audio call but is able to accept an incoming 64 kbit/s unrestricted call, the introduction of an interworking function in the PISN can be achieved only if there is service negotiation between the PISN and the called terminal adaptor. This capability is outside the scope of this Standard.

6.6 Static Description: Service Attributes

For details concerning the structuring of service attributes, see annex A.

• Dominant information transfer attributes

The dominant information transfer attribute values for this service category shall be:

- 1) Information transfer mode: circuit;
- 2) Information transfer rate: 64 kbit/s;
- 3) Information transfer capability: unrestricted;
- 4) Structure: 8 kHz integrity.

• Secondary information transfer attributes

The secondary information transfer attribute values for this service category shall be:

- 5) Establishment of communication: demand or reserved or permanent (see Note 14);
- 6) Symmetry: bidirectional symmetric or unidirectional (see Note 15);
- 7) Communication configuration: point-to-point or multi-point (see Note 16).

• Access attributes

The access attribute values for this service category shall be (see Note 17):

- 8) Access channel: B;

¹ Terminals that support certain ITU-T Recommendations such as V.24, V.28, V.10 and V.11.

- 9) Access protocol: Not defined.

NOTES

14. *Only demand services are specified in this Standard.*
15. *Only bidirectional symmetric services are specified in this Standard.*
16. *Only point-to-point services are specified in this Standard. Multi-point configurations can be achieved using conference call supplementary services.*
17. *The access attributes refer only to the user information not the signalling information.*

7 Circuit-mode 64 kbit/s 8 kHz structured bearer service category usable for speech information transfer

7.1 Definition

This bearer service category is intended to support speech.

User information shall conform to ITU-T Rec. G.711 (A-law or μ -law). The network may use processing techniques appropriate for speech such as analogue transmission, echo cancellation and low bit rate voice encoding. Hence, bit integrity is not assured. This bearer service category is not intended to support modem generated voice band data.

All ITU-T recommendations for the transfer of speech information in a network apply to this service.

7.2 Description

This circuit-mode bearer service category allows:

- two PISN users in a point-to-point configuration to communicate in a point to point configuration via the network using speech encoded into 64 kbit/s digital signals, in both directions continuously and simultaneously for the duration of a call;
- in conjunction with a conference call supplementary service, three or more PISN users to communicate in a multi-point configuration.

Once the information channel connection has been established according to the procedures described in clauses 9 to 11, it is available for the transmission of speech encoded into 64 kbit/s digital signals in both directions continuously and simultaneously. Bit integrity is not assured. The network may use analogue transmission.

The network shall provide tones and announcements to indicate the progress or otherwise of a call.

7.3 Procedures

These are common to all services in this Standard and are given in section 9.

7.4 Network capability for charging

This is outside the scope of this Standard.

7.5 Interworking considerations

7.5.1 Interworking with a public ISDN and certain other digital networks

Services specified in this Standard are able to interwork with the same services in a public ISDN. The interworking function for user information transfer is null.

7.5.2 Interworking with analogue networks

This bearer service category is able to interwork with PSTNs and private analogue networks when calls originate in the PISN. For calls from an analogue network to the PISN, the analogue network is generally unable to indicate the service required, and in this case the PISN provides a 3,1 kHz audio bearer service rather than a speech bearer service, in order to allow for the possibility of voice band data. Calls from the PSTN shall always use 3,1 kHz audio.

7.5.3 Encoding law conversion

The PISN may provide A-law/ μ -law conversion (see ITU-T Rec. G.711) to permit interworking between terminals and interfaces to other networks which do not all conform to the same encoding law (A-law or μ -law).

NOTE 18

Although in general a network which uses μ -law encoding should provide A-law/ μ -law conversion when interworking with networks which use A-law, this may not apply in the case of a private network using A-law and a public network using μ -law. Therefore even if the PISN uses A-law and expects its terminals and other private networks to use A-law, it may need to provide A-law/ μ -law conversion when interworking with public networks which use μ -law.

7.6 Static Description: Service Attributes

For details concerning the structuring of service attributes, see annex A.

- **Dominant information transfer attributes**

The dominant information transfer attribute values for this service category shall be:

- 1) Information transfer mode: circuit;
- 2) Information transfer rate: 64 kbit/s;
- 3) Information transfer capability: speech (encoded)
- 4) Structure: 8 kHz integrity.

- **Secondary information transfer attributes**

The secondary information transfer attribute values for this service category shall be:

- 5) Establishment of communication: demand or reserved or permanent (see Note 19);
- 6) Symmetry: bidirectional symmetric or unidirectional (see Note 20);
- 7) Communication configuration: point-to-point or multi-point (see Note 21).

- **Access attributes**

The access attribute values for this service category shall be (see Note 22):

- 8) Access channel: B;
- 9) Access protocol: According to ITU-T Rec. G.711 (A-law or μ -law).

NOTES

19. *Only demand services are specified in this Standard.*
20. *Only bidirectional symmetric services are specified in this Standard.*
21. *Only point-to-point services are specified in this Standard. Multipoint configurations can be achieved using conference call supplementary services.*
22. *The access attributes refer only to the user information not the signalling information.*

8 Circuit-mode 64 kbit/s 8 kHz structured bearer service category usable for 3,1 kHz audio information transfer

8.1 Definition

This bearer service category corresponds to the service which is currently offered in the PSTN. It provides for the transfer of speech and of 3,1 kHz bandwidth audio information such as voice band data via modems and facsimile groups 1, 2 and 3 information (see Note 23).

User information shall conform to ITU-T Rec. G.711 (A-law or μ -law). The network may use processing techniques appropriate for speech, provided they are appropriately modified or functionally removed prior to non-speech information transfer. The control of echo control devices, speech processing devices, etc. is made by the use of disabling tones.

All ITU-T recommendations for the transfer of speech information in a network shall apply to this service.

NOTE 23

The maximum modem bit rate that can be used by PISN users in applications of this bearer service category depends on the modulation standard employed and on the transmission performance of the networks involved.

8.2 Description

This circuit-mode bearer service category allows:

- two PISN users in a point-to-point configuration to communicate via the network using 3,1 kHz audio information encoded into 64 kbit/s digital signals, in both directions continuously and simultaneously for the duration of a call;
- three or more PISN users to communicate in a multi-point configuration in conjunction with a conference supplementary service.

Once the information channel connection has been established according to the procedures described in clauses 9 to 11, it is available for the transmission of 3,1 kHz audio information encoded into 64 kbit/s digital signals in both directions continuously and simultaneously. Bit integrity is not assured. The network may use analogue transmission.

The network shall provide tones and announcements to indicate the progress or otherwise of a call.

8.3 Procedures

These are common to all services in this Standard and are given in clause 9.

8.4 Network capability for charging

This is outside the scope of this Standard.

8.5 Interworking considerations

8.5.1 Interworking with a public ISDN and certain other digital networks

Services in this category are able to interwork with the same services in a public ISDN. The interworking function for user information transfer is null.

8.5.2 Interworking with analogue networks

This bearer service category is able to interwork with PSTNs and private analogue networks. For calls from an analogue network to the PISN, the analogue network is generally unable to indicate the service required, and in this case the PISN shall always provide a 3,1 kHz audio bearer service.

8.5.3 Encoding law conversion

The PISN may provide A-law/ μ -law conversion (see ITU-T Rec. G.711) to permit interworking between terminals and interfaces to other networks which do not all conform to the same encoding law (A-law or μ -law).

NOTE 24

Although in general a network which uses μ -law encoding should provide A-law/ μ -law conversion when interworking with networks which use A-law, this may not apply in the case of a private network using A-law and a public network using μ -law. Therefore even if the PISN uses A-law and expects its terminals and other private networks to use A-law, it may need to provide A-law/ μ -law conversion when interworking with public networks which use μ -law.

8.6 Static Description: Service Attributes

For details concerning the structuring of service attributes, see annex A.

- **Dominant information transfer attributes**

The dominant information transfer attribute values for this service category shall be:

- 1) Information transfer mode: circuit;
- 2) Information transfer rate: 64 kbit/s;
- 3) Information transfer capability: 3,1 kHz audio (encoded);

4) Structure: 8 kHz integrity.

- **Secondary information transfer attributes**

The secondary information transfer attribute possibilities for this service category shall be:

5) Establishment of communication: demand or reserved or permanent (see Note 25);

6) Symmetry: bidirectional symmetric or unidirectional (see Note 26);

7) Communication configuration: point-to-point or multi-point (see Note 27).

- **Access attributes**

The access attribute values for this service category shall be (see Note 28):

8) Access channel: B;

9) Access protocol: According to ITU-T Rec. G.711 (A-law or μ -law).

NOTES

25. *Only demand services are specified in this Standard.*

26. *Only bidirectional symmetric services are specified in this Standard.*

27. *Only point-to-point services are specified in this Standard. Multipoint configurations can be achieved using conference call supplementary services.*

28. *The access attributes refer only to the user information not the signalling information.*

9 Common procedures for services within a PISN

The procedures of this clause shall apply when the users concerned are users of a PISN.

9.1 Provision of services

As a PISN option, a basic service available in a PISN can be generally available, or can be available by specific arrangement for an individual PISN user.

9.2 Normal procedures

9.2.1 Call establishment at the calling PISN user

The calling PISN user shall originate a call by transferring across a service access point a request for call establishment (SETUP_request). This request shall include the following information:

- a) Bearer Capability information defining the bearer capabilities required of the network;
- b) a number identifying the called PISN user (Destination Number);

NOTE 29

The number information may be complete (so called "en bloc sending" mode) or incomplete (so called "overlap sending" mode).

- c) the Originating Number if multiple numbers have been assigned to the calling PISN user's access;

and may include,

- d) the called PISN user's subaddress, to further identify the called PISN user (Destination Subaddress);
- e) information describing user information transfer protocols for layers up to layer 3, Low Layer Compatibility (LLC) information;
- f) information describing user information transfer protocols for layer 4 and above, High Layer Compatibility (HLC) information;
- g) the PISN user's own subaddress (Originating Subaddress) to identify itself to the called PISN user.

The Bearer Capability shall consist of a list of the low layer attributes for the bearer service required. It may include additional low layer protocol information which is not required in order to indicate the service but which can be of use to the PISN in potential interworking situations.

The Destination Number shall consist of the number digits, the identification of the numbering plan and the type of number, in accordance with ISO/IEC 11571. The PISN user may provide the complete Destination Number to the PISN with the service request (SETUP_request), or by use of the overlap sending mode (e.g., digit-by-digit). In the latter case, any Destination Number information not supplied in the SETUP_request shall be supplied in one or more subsequent INFORMATION_requests.

NOTE 30

In some countries, overlap sending is not used.

The Destination Subaddress, if supplied consists of the “type of subaddress” indicator and the actual subaddress, in accordance with ISO/IEC 11571.

The LLC information is additional to the Bearer Capability information. The PISN shall pass the LLC information to the called PISN user, where it can be used for compatibility checking. The network shall not use the LLC information.

The PISN shall pass the HLC information to the called PISN user, where it can be used for compatibility checking.

The Originating Subaddress consists of the “type of subaddress” indicator and the actual subaddress, in accordance with ISO/IEC 11571.

For case (c) above, the PINX shall screen the provided Originating number. If the Originating Number is determined to be one of the numbers assigned to that access, the PISN shall use this Originating Number and classify it “USER PROVIDED, VERIFIED AND PASSED”. If no Originating Number is provided or it is determined not to be one of the set of multiple numbers assigned to that access, the PISN shall provide a pre-arranged default Originating Number classified as “NETWORK PROVIDED”. For the format and type of number see ISO/IEC 11571. For all other cases, even if the Originating number is provided by the user, the PINX shall always use the network determined number with the indication NETWORK PROVIDED.

NOTES

31. *The presentation of the Connected Number and Subaddress and the screening results to the calling PISN user is beyond the scope of this Standard.*
32. *The connected PISN user's number may be different from the called PISN user's number because of local functions at the destination PINX. Such actions are outside the scope of this Standard.*

Depending on the behaviour of the called PISN user, the PISN shall indicate to the calling PISN user that the called PISN user is being alerted (REPORT_indication)

When the called PISN user has answered, the PISN shall give confirmation (SETUP_confirmation) of the call establishment request to the calling PISN user. The confirmation may optionally contain:

- the connected PISN user's subaddress,
- the Lower Layer Compatibility information, and
- High Layer Compatibility information

if they have been provided. The called user may use the LLC and HLC information for compatibility checking. For certain service categories the network shall also provide in-band tones and announcements to the calling PISN user during call establishment, see clauses 7 and 8. The PISN user shall receive an indication of the presence of an in-band tone or announcement (REPORT_indication).

9.2.2 Call establishment at the called PISN user

If the PISN is able to route the call to the requested destination, (taking account of other relevant information in the service request), it shall transfer an incoming call indication (SETUP_indication) across the service access point to the called PISN user. The incoming call indication shall include the following items of information:

- a) Bearer Capability information;

- b) Low Layer Compatibility information, if provided by the calling PISN user;
- c) High Layer Compatibility information, if provided by the calling PISN user;
- d) the Destination Subaddress, if provided by the calling PISN user;
- e) if multiple numbers have been arranged at the access, the network shall provide the Destination Number;
- f) the Originating Subaddress, if provided by the calling PISN user.

If the called PISN user enters an alerting phase, the PISN user shall transfer a REPORT_request across the service access point to the PISN.

In order to accept the call, the called PISN user shall transfer across the service access point, a response to the incoming call indication (SETUP_response). The network shall then complete the connection for user information between the calling and called PISN users, in accordance with the service requested.

For case (e) above, the PISN user accepting the call shall provide its number (Connected Number) to the network with the SETUP_response. The PISN shall screen the provided Connected number. If the Connected Number is determined to be one of the numbers assigned to that access, the PISN shall use this Connected Number and classify it "USER PROVIDED, VERIFIED AND PASSED". If no Connected Number is provided or it is determined not to be part of the set of multiple numbers assigned to that access, the PISN shall provide a pre-arranged default Connected Number classified as "NETWORK PROVIDED". For the format and type of number see ISO/IEC 11571.

NOTE 33

The presentation of the Originating Number and Subaddress and the screening results to the called PISN user is beyond the scope of this Standard.

Where there is more than one destination service access point which is compatible with the requirements of the call (Bearer Capability, Destination Number and, if supplied, Destination Subaddress, Low Layer Compatibility, High Layer Compatibility), the PISN shall transfer the SETUP_indication across all compatible service access points. The first REPORT_request received shall result in a REPORT_indication being transferred to the calling PISN user. The PISN shall award the call to the first service access point across which a SETUP_response is received from the PISN user. The network shall send a RELEASE_request across any other service access points across which the SETUP_indication was sent.

The SETUP_response may include, as a PISN user option, the connected PISN user's own subaddress (i.e., Connected Subaddress), low layer compatibility information and high layer compatibility information.

9.2.3 Terminating the service (call release)

The call may be released by either of the PISN users by transferring a request for release (RELEASE_request) across its service access point. The network shall:

- transfer back across the same service access point a confirmation of release (RELEASE_confirmation),
- transfer an indication of release (RELEASE_indication) with an appropriate cause across the other PISN user's service access point, and
- expect to receive a RELEASE_response from that PISN user.

For certain services an in-band tone or announcement may accompany the RELEASE_indication.

9.3 Exceptional procedures / unsuccessful outcome

In the event that the network is unable to establish a call, it shall give an indication of release (RELEASE_indication) with an appropriate cause to the calling PISN user and cease call establishment. The cause shall include an indication of the location at which the failure occurred, i.e., the network (PISN) or the remote PISN user's terminal equipment. The network shall be prepared to receive a RELEASE_response from the calling PISN user.

If the called PISN user cannot accept a call, the PISN user may transfer a RELEASE_request with an appropriate cause to the network. The network shall transfer a RELEASE_confirmation back across the same service access point. If no SETUP_response is received across any service access point across which the SETUP_request was

transferred, the network shall transfer a RELEASE_indication with an appropriate cause across the calling PISN user's service access point; and shall be prepared to receive a RELEASE_response.

For certain services the network may also provide in-band tones and announcements in the event of failure. The PISN shall give an indication of the presence of an in-band tone or announcement (REPORT_indication) to the PISN user.

The main categories of service failure are as listed below.

- **Failure situations due to calling PISN user error**
 - a) A PISN user inputs a network identifiable improper service request.
 - b) A PISN user inputs a non-valid Destination Number (or fails to input a valid number in the time allowed).
 - c) A PISN user requests a service in contradiction to the service profile of the service access point, e.g., particular basic service not allowed, outgoing calls barred.
- **Failure situations due to called PISN user state**
 - a) There is no destination service access point which is compatible with the requirements of the call, i.e., the Bearer Capability and Destination Number.
 - b) The incoming call is barred according to the service profile of the called service access point(s), e.g., particular basic service not allowed, incoming calls barred, interconnection of the calling and called service access points barred.
 - c) There is a lack of resources at all compatible destination service access points.
- **Failure situations due to network conditions**
 - a) The network is unable to comply with the call request because of temporary lack of resources, e.g., all information channels at the calling PISN user are busy, all suitable network paths are busy.
 - b) The network is unable to comply with the call request because of medium term or long term conditions, e.g., no route to the required destination for the basic service concerned, equipment out of service.
- **Rejection of the call by the called PISN user**
 - a) The called PISN user is unable to comply with the call request attributes. This decision can be based on any of the following: Destination Number, Destination Subaddress, Bearer Capability information, Low Layer Compatibility information, High Layer Compatibility information, or for any other reason.
 - b) The called PISN user is unable to comply with the call request because of temporary lack of resources.
- **Absence of response from called PISN user**
 - a) The called PISN user fails to enter an alerting phase or answer within a defined period of time after being given an incoming call indication.
 - b) The called PISN user fails to answer within a defined period of time after entering an alerting phase.

NOTE 34

This results in an unsuccessful call.

10 Interworking

Interworking occurs when the Network Layer spans across the PISN operator's and other network operators' domains.

10.1 General Interworking considerations

10.1.1 Incoming calls

An incoming call to a PISN occurs when a PISN user is the called user. The other network can provide the originating number in the setup indication. The interpretation of any screening information may be considered as an implementation matter.

The PISN shall include in the SETUP_indication to the called PISN user, an indication of interworking and the type of the other network (ISDN or non-ISDN). Certain information can be missing from the SETUP_indication on account of it not being provided by the other network. The details of this information and the default mechanism required to cope with their non-availability are beyond the scope of this Standard.

NOTE 35

In some countries interworking indications can be mandatory for regulatory reasons.

10.1.2 Outgoing calls

An outgoing call from a PISN occurs when a PISN user is the calling user. The PISN may provide (either in a REPORT_indication or in the SETUP_confirmation) to the calling PISN user, an indication of interworking and the type of the other network (ISDN or non-ISDN).

NOTES

36. In some countries interworking indications can be mandatory for regulatory reasons.

37. In some situations, the PISN may discard information provided by the calling user for delivery to the called user, if the capability of the other network is limited.

When a call is rejected by the other network, then depending on the capabilities of this network, the PISN may send a special cause indication (i.e., other than those normally used within a PISN) to the calling user. The cause shall as a minimum indicate that the location of the failure is beyond the PISN.

Some other networks can provide in-band tones and announcements during call establishment for certain services. Unless the PISN can provide alternative indications to the calling user, it shall establish at least a backward connection of information channels so that tones and announcements are conveyed to the calling PISN user.

The default mechanism required to cope with the non-availability of detailed information to the other network is beyond the scope of this Standard.

10.1.3 PISN transit calls

A transit call occurs when neither user is a PISN user and the call is routed through the PISN in order to get from the calling user's network to the called user's network.

NOTE 38

There can be restrictions for this type of call because of, for example, regulatory or transmission requirements.

10.2 Interworking with public-ISDN

10.2.1 Receipt of service request from a public ISDN

Subclause 10.1.1 applies.

The details of the information which an incoming call request can indicate to the PISN are beyond the scope of this Standard. It however depends on the interworking situations and on the capabilities available in the public ISDN. For an incoming call, the PISN shall be able to accept the following information:

- a) Bearer Capability information defining the bearer capabilities required by the public ISDN;
- b) Low Layer Compatibility and High Layer Compatibility information from the calling user;
- c) a number identifying the called PISN user (Destination Number), e.g., provided by the DDI supplementary service of a public ISDN;
- d) the called PISN user's subaddress (Destination Subaddress), e.g., provided by the Subaddressing supplementary service of a public ISDN;
- e) the calling user's number (Originating Number) provided by the Calling Line Identification Presentation supplementary service of a public ISDN;
- f) the calling user's subaddress (Originating Subaddress), provided by the Calling Line Identification Presentation supplementary service of a public ISDN.

The Bearer Capability consists of a list of the low layer attributes of the required bearer service. It can also include additional low layer protocol information which is not required in order to indicate the service, but which could be of use in certain interworking situations. Due to the prevailing interworking situation, the Bearer Capability indicated to the PISN can be a default value, and need not reflect the Bearer Capability originally requested by the calling user. In this case, the PISN shall forward the Bearer Capability and the default indication to the PISN user.

The Destination Number consists of the number digits, the identification of the numbering plan and the type of number, in accordance with ITU-T Rec. I.251.1.

If the DDI supplementary service does not apply, the Destination Number may not be provided. The further treatment of such an incoming call request is a PISN option and beyond the scope of this Standard.

The PISN shall not screen the Originating Number received from a public ISDN. For the parameters received with the Originating Number see ITU-T Rec. I.251.3.

NOTE 39

The presentation of the Originating Number and Originating Subaddress to the called PISN user is beyond the scope of this Standard.

The PISN shall pass the Low Layer Compatibility information, High Layer Compatibility information, and the Destination Subaddress, if provided, to the called PISN user.

10.2.2 Sending a service request to a public ISDN

Subclause 10.1.2 applies.

NOTE 40

The specification of the calling PISN user's identity that is sent to a public ISDN is beyond the scope of this Standard.

10.2.3 Receipt of a service response from public ISDN

The details of the information which an outgoing call response can indicate to the PISN are beyond the scope of this Standard. They can depend on the interworking situations and/or on the availability of certain capabilities from a public ISDN. The information that the PISN shall be prepared to accept and pass on to the calling PISN user is listed below:

- a) the connected user's number (Connected Number) provided by the Connected Line Identification Presentation supplementary service of a public ISDN;
- b) the connected user's subaddress (Connected Subaddress), provided by the Connected Line Identification Presentation supplementary service of a public ISDN;
- c) Low Layer Compatibility information from the connected user.

The PISN shall not screen the Connected Number received from a public ISDN. The parameters received with the Connected Number are specified in ITU-T Rec. I.251.5.

NOTE 41

The presentation of the Connected Number and Connected Subaddress to the calling PISN user is beyond the scope of this Standard.

10.2.4 Sending service response to public ISDN

The details of the information that the PISN can provide to the public ISDN are beyond the scope of this Standard. The PISN shall if permitted indicate the condition "interworking with a private ISDN" in the SETUP_response sent to the public ISDN. The PISN may if appropriate indicate the progress of the call to the public ISDN (e.g., "alerting") by sending a REPORT_indication.

11 Dynamic Description

Figure 3 contains the overall dynamic description (using SDL conventions), of a basic call within a PISN. The SDL diagram shall be interpreted as follows:

- a) The SDL process represents the behaviour of the Network Call Control entity.

- b) Input signals from the left and output signals to the left represent primitives from and to the calling PISN user.
- c) Input signals from the right and output signals to the right represent primitives from and to the called PISN user.
- d) The offering of a call to more than one destination service access point is not shown.
- e) Interworking with other networks is not shown.
- f) The following states are used:
 - IDLE – no call in progress;
 - AWAIT DESTINATION NUMBER – the network is awaiting further Destination Number information from the calling PISN user;
 - AWAIT CALLED USER RESPONSE – an indication of the incoming call has been sent to the called PISN user but no response has been received;
 - AWAIT ANSWER – a report of alerting has been received from the called PISN user but answer has not occurred;
 - ACTIVE – the call has been answered;
 - AWAIT CALLING USER RELEASE – an indication of release has been sent to the calling PISN user and a response is awaited;
 - AWAIT CALLED USER RELEASE – an indication of release has been sent to the called PISN user and a response is awaited.

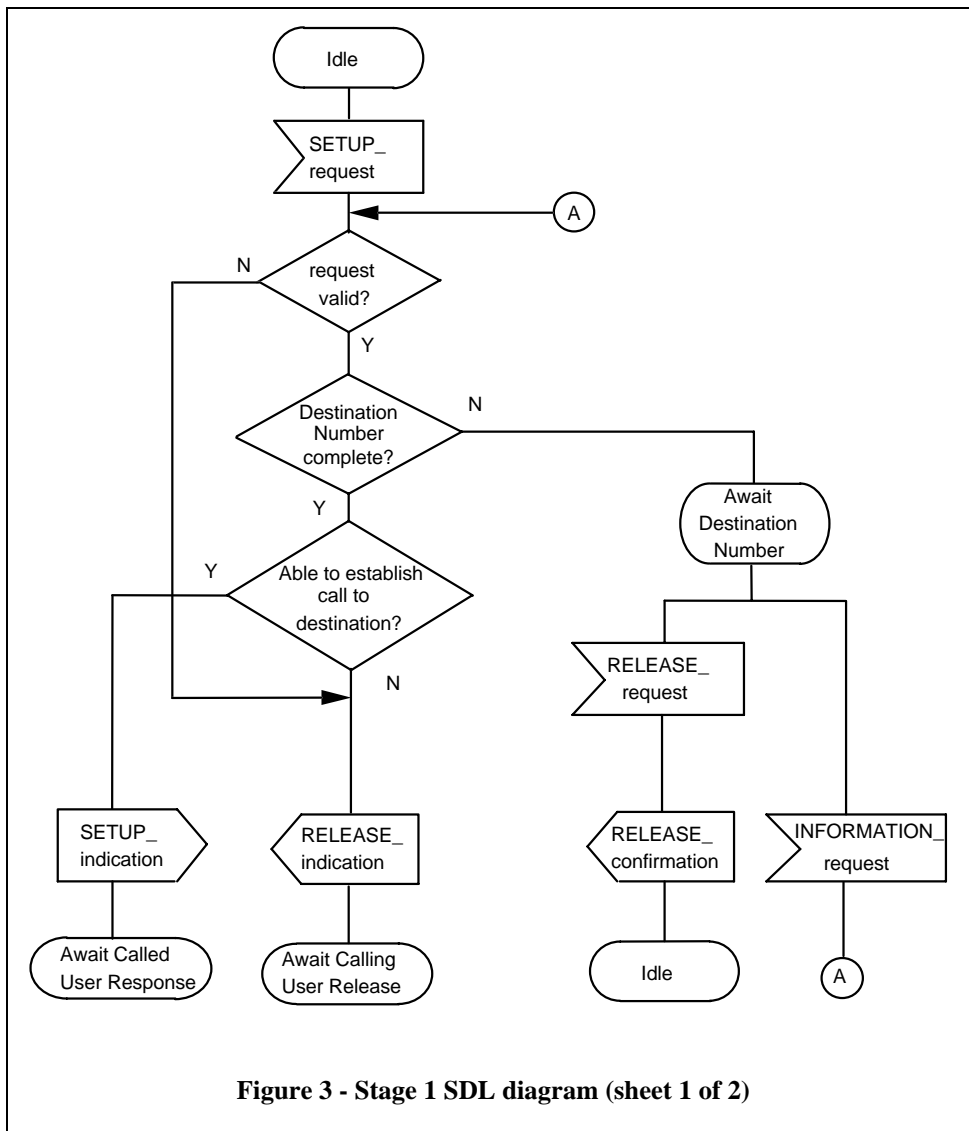

Figure 3 - Stage 1 SDL diagram (sheet 1 of 2)

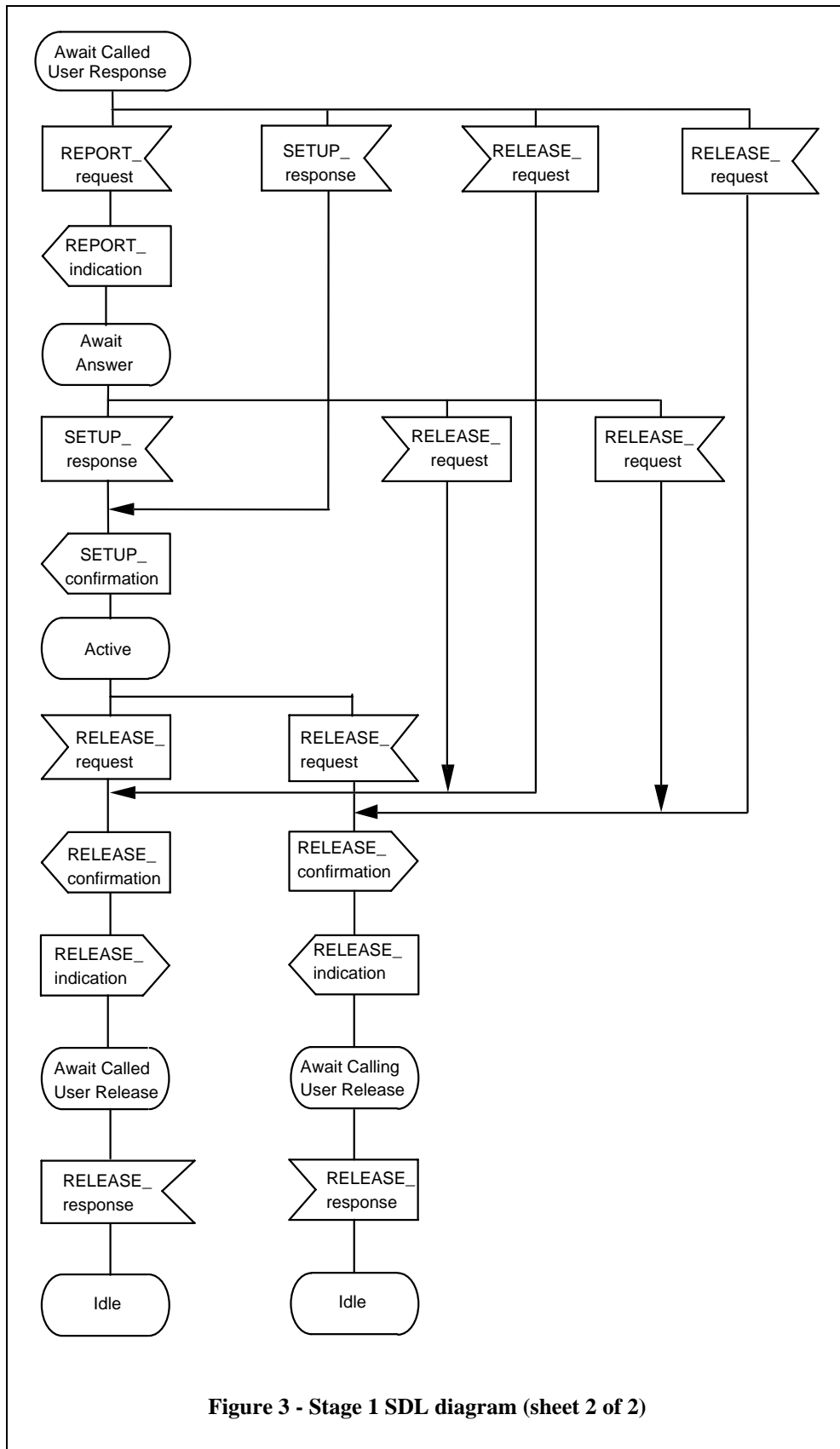

Figure 3 - Stage 1 SDL diagram (sheet 2 of 2)

Section 3: Functional capabilities and information flows (stage 2 description)

12 Functional model

12.1 Functional model description

The internal behaviour of the Network Call Control is specified by dividing it into a number of functional entities, and by specifying the information flows between these functional entities. This has been described in general terms in clause 5.5. The particular functional entities used in the Functional Model for the Basic Call are specified below.

The Basic Call model shall consist of two generic functional entities namely,

- the Call Control Agent (CCA), and
- the Call Control (CC);

and three functional relationships, defined as:

- r1 – the access relationship at the originating side between a Call Control Agent functional entity and a Call Control functional entity, and
- r2 – the distributive relationship between a Call Control functional entity and another Call Control functional entity.
- r3 – the access relationship at the destination side between a Call Control Agent functional entity and a Call Control functional entity.

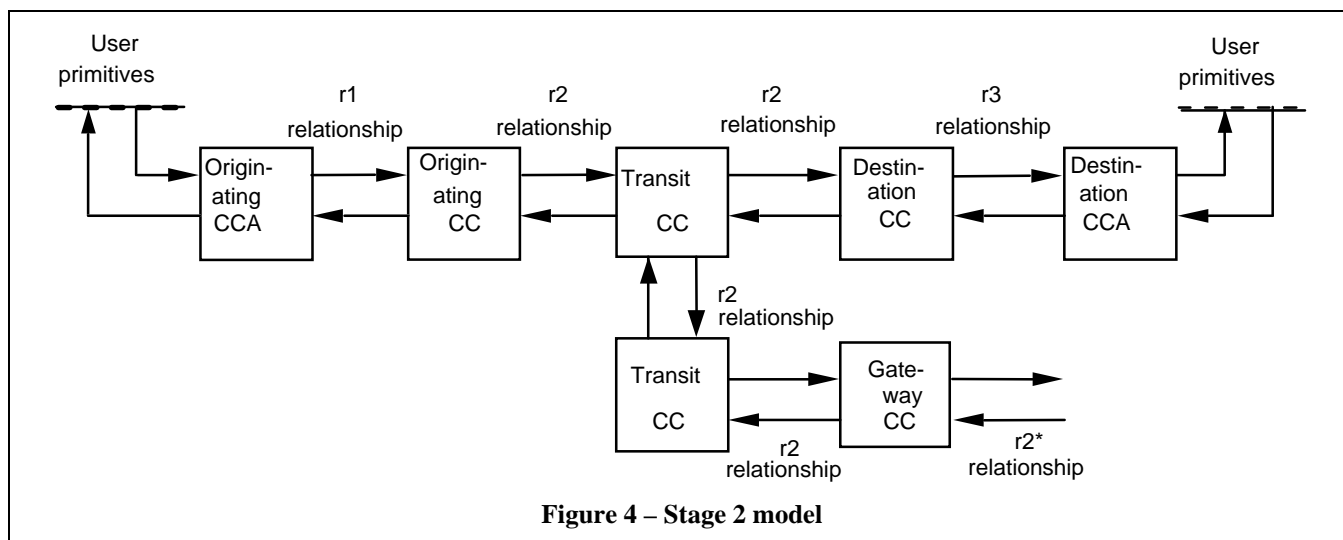

Figure 4 – Stage 2 model

An additional type of r2 relationship is used in clause 14; it is called r2*, and shall be the relationship between the Gateway CC functional entity of a PISN and the access CC functional entity of a public ISDN. The definition of the r2* relationship is beyond the scope of this Standard.

The functional model is shown in figure 4. The arrows between the PISN users and the CCA represent PISN user primitives, the arrows between the CC functional entities and either CC functional entities or CCA functional entities represent information flows.

12.2 Description of the functional entities

The allocation of the functional entities (that are described in this clause) to physical entities, is given in clause 16. The allocation is done on a per call basis.

NOTE 42

Examples of the use of these functional entities, in conjunction with the Stage 2 model are shown in figures 6 to 15.

12.2.1 Call Control Agent functional entity

The Call Control Agent functional entity (CCA functional entity) is that part of the Network Call Control that serves the PISN user. It is responsible for:

- formulating requests to, and
- responding to indications from

the network that is providing the Basic Services.

Within this Standard the following types of CCA functional entity are described:

- Originating CCA functional entity, and
- Destination CCA functional entity.

12.2.1.1 Originating CCA functional entity

An Originating CCA functional entity is the CCA functional entity that serves the PISN user that has initiated the Basic Service request. The Originating CCA functional entity shall have the following capabilities:

- ability to access the service-providing capabilities of the CC functional entities, using service requests for the establishment and release of a single call,
- ability to receive indications relating to the call from the CC functional entity and relay them to the PISN user,
- ability to maintain call state information as perceived from this functional end-point of the call (i.e. a single ended view of the call).

NOTE 43

Other capabilities that the Originating CCA functional entity can have are beyond the scope of this Standard and are therefore not specified.

12.2.1.2 Destination CCA functional entity

A Destination CCA functional entity is the CCA functional entity that serves the PISN user at which the call terminates. The Destination CCA functional entity shall have the following capabilities:

- ability to establish and release a single incoming call,
- ability to receive indications relating to the call from the CC functional entity and relay them to the PISN user,
- ability to maintain call state information as perceived from this functional end-point of the call (i.e., a single ended view of the call).

NOTE 44

Other capabilities that the Destination CCA functional entity can have are beyond the scope of this Standard and are therefore not specified.

12.2.2 Call Control functional entity

The Call Control functional entity (CC functional entity) is the functional entity within the network that cooperates with other Call Control functional entities to provide the Basic Service requested by the CCA functional entity. There are different types of CC functional entities each with specific capabilities. Within this Standard the following types of CC functional entities are specified:

- Originating CC functional entity,
- Transit CC functional entity,
- Destination CC functional entity,
- Incoming Gateway CC functional entity,
- Outgoing Gateway CC functional entity.

12.2.2.1 Originating CC functional entity

An Originating CC functional entity is the functional entity within the network that has a direct relationship with the Originating CCA functional entity. The Originating CC functional entity shall have the following capabilities:

- the ability to establish, and release a single call, upon request of the Originating CCA functional entity,
- the ability to associate and mediate between the Originating CCA functional entity and the subsequent CC functional entity involved in a particular call.

An Originating CC functional entity may also have the following capability:

- the ability to provide tones and announcements.

The ability to process the Basic Service request can include the ability to validate any Basic Service request against any relevant service profile appertaining to the PISN user.

NOTE 45

Other capabilities that Originating CC functional entities can have are beyond the scope of this Standard and are therefore not specified.

12.2.2.2 Destination CC functional entity

A Destination CC functional entity is the functional entity within the network that has a direct relationship with the Destination CCA functional entity. The Destination CC functional entity shall have the following capabilities:

- the ability to establish, and release a single call to the Destination CCA functional entity, on behalf of the network,
- the ability to associate and mediate between the Destination CCA functional entity and the preceding CC functional entity involved in a particular call.

A Destination CC functional entity may also have the following capabilities:

- the ability to mediate between more than one Destination CCA functional entities during the call setup phase.
- the ability to provide tones and announcements.

The ability to process the Basic Service request can include the ability to validate any Basic Service request against any relevant service profile appertaining to the PISN user.

NOTE 46

Other capabilities that the Destination CC functional entity can have are beyond the scope of this Standard and are therefore not specified.

12.2.2.3 Transit CC functional entity

A Transit CC functional entity is the CC functional entity within the network that has a direct relationship with other CC functional entities that are within the PISN. The Transit CC functional entity shall have the following capabilities:

- the ability to establish, and release a single call between two CC functional entities,
- the ability to associate and mediate between the CC functional entities involved in a particular call.

A Transit CC functional entity may also have the following capability:

- the ability to provide tones and announcements.

NOTE 47

Other capabilities that the Transit CC functional entity can have are beyond the scope of this Standard and are therefore not specified.

12.2.2.4 Incoming and Outgoing Gateway CC functional entities

A Gateway CC functional entity is the functional entity within the PISN that interworks with the access functional entity of another network. Depending on whether the call originates in the PISN or in the other network, the gateway CC functional entity may be either an Incoming Gateway CC functional entity or an Outgoing Gateway CC functional entity.

A Gateway CC functional entity shall have the same capabilities as a Transit CC functional entity.

NOTES

48. *Gateway CC functional entities can have other capabilities depending upon the type of network that it is interworking with. The particular capabilities of the Gateway CC are determined by the level of signalling that is available for interworking to the other network. These additional capabilities are beyond the scope of this Standard.*
49. *In the scenario where the network that is being interworked with is a public ISDN, a high level of interworking of the information flows can take place.*
50. *Other capabilities, not related to interworking, that the Gateway CC functional entity can have are beyond the scope of this Standard and are therefore not specified.*

13 Definition of information flows

13.1 Conventions used within the description of information flows

13.1.1 Convention for the description of mandatory or optional information

In this document the information flows that support the Basic Call service have been divided into “service elements”. The service elements themselves have been divided where relevant into “service parameters”. The information content of each service parameter has been listed when necessary.

In order to indicate the circumstances in which the various service elements and parameters are used, the following conventions are used.

- M – the information flow shall contain the service element, (i.e., it is mandatory),
- O – the information flow may contain the service element (i.e., it is optional).

Unless stated otherwise, a service element shall be passed on at a Transit CC functional entity if the information flow is passed on.

A similar convention is used for the parameters within the service elements.

- m – the service element shall contain the service parameter, (i.e., it is mandatory),
- o – the service element may contain the service parameter, (i.e., it is optional).

13.1.2 Convention for the naming of information flows

A sending FE shall regard an unconfirmed information flow as a “request”, and the receiving FE shall regard the same information flow as an “indication”.

A sending FE shall regard the requesting half of a confirmed information flow as a “request”, and the receiving FE shall regard the same information flow as an “indication”.

The sending FE shall regard the responding half of a confirmed information flow as a “response”, and the receiving FE shall regard the same information flow as a “confirmation”.

An information flow of name “ABCD” is represented as “ABCD_request” or “ABCD_response” from the perspective of the sending FE. The information flow is represented as “ABCD_indication” or “ABCD_confirmation” from the perspective of the receiving FE.

The information flow of name “ABCD” is represented as “ABCD_request/indication” or “ABCD_response/confirmation” when used in a context that is not from the perspective of a particular FE.

To show the use of an information flow across a particular relationship “rX” the name is preceded by “rX_” (e.g. r2_ABCD_request/indication).

In clause 14 the primitive and information flows are shortened as follows:

- “request” to “req”;
- “indication” to “ind”;
- “response” to “resp”; and
- “confirmation” to “cfm”.

Figure 5 shows information flows used in conjunction with the functional model, with the specific example shown of a confirmed information flow being initiated by the PISN user on the “left-hand side”.

In clauses 14 and 15 the terms “Backward” and “Forward” are used. At a particular functional entity the direction towards the Originating PISN user is called the “Backward” direction. The direction towards the Destination PISN user is called the “Forward” direction.

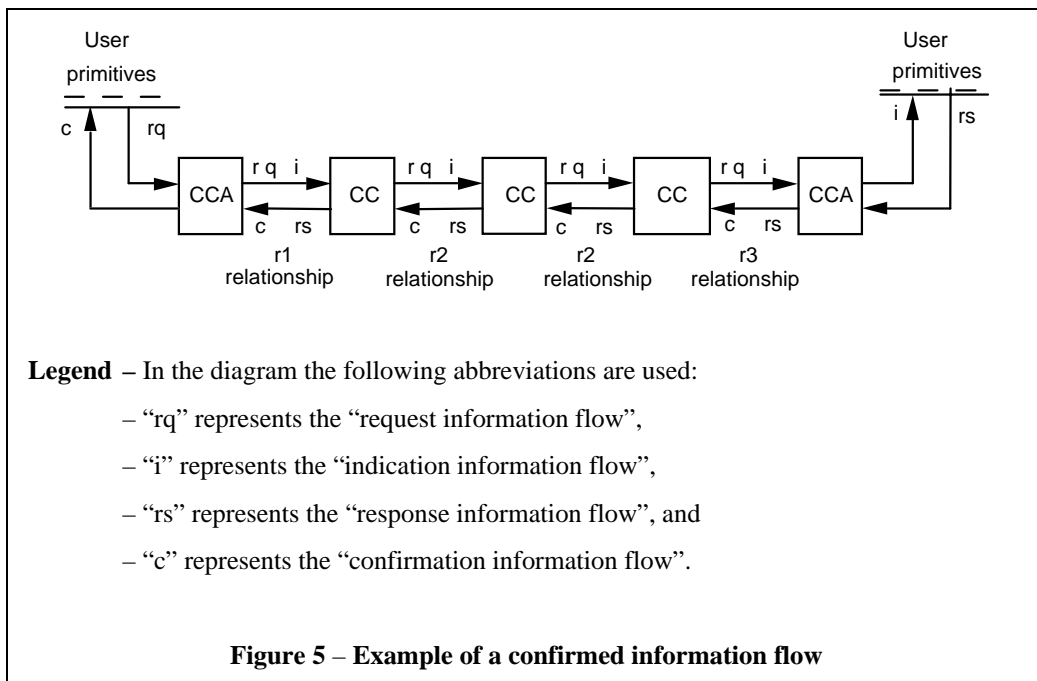

13.2 SETUP

A functional entity shall use the SETUP information flow to request the establishment of a connection. SETUP is a confirmed information flow. The responding part of SETUP shall confirm to the originating functional entity, that the requested connection has been established. In call failure situations other information flows (e.g. RELEASE) may replace the SETUP_response/confirmation. SETUP may be used within the relationships r1, r2 and r3. SETUP shall convey the service elements that are shown in table 1. The detailed contents of these service elements are shown in table 2.

Table 1 – Information content of SETUP

Service element	Relationship	Request/Indication	Response/Confirmation
DN Destination Number	r1, r2, r3	M (note 1)	–
CN Connected Number	r2, r3	–	M (note 2)
ON Originating Number	r2, r1	M (note 3)	–
CT Connection Type	r1, r2, r3	M (note 4)	O
DS Destination Subaddress	r1, r2, r3	O	–
CS Connected Subaddress	r2, r3	–	O
OS Originating Subaddress	r2, r1	O	–
CI Channel Identifier	r1, r2, r3	M (note 5)	–
CH Call History	r1, r2, r3	O (note 6)	O (note 6)
Note — The notes are same as those for table 2.			

Table 2 – Detailed information content of SETUP

Service element	Request/Indication	Response/Confirmation
DN Destination Number	(note 1) – M Number – m Numbering plan identifier – m Type of number – m Number complete indicator (note 7) – o	-
CN Connected Number	-	(note 2) – M Number (note 8) – m Numbering plan identifier – m Type of number – m Presentation restriction – m Screening indicator – m
ON Originating Number	(note 3) – M Number (note 8) – m Numbering plan identifier – m Type of number – m Presentation restriction – m Screening indicator – m	-
CT Connection Type – Circuit Mode Bearer: 64 kbit/s unrestricted (note 10)	(note 4) – M Information transfer capacity: 64 kbit/s unrestricted – m High layer compatibility – o Low layer compatibility – o Information transfer mode: circuit – m Information transfer rate: 64 kbit/s – m Establishment (note 9) – o Symmetry (note 9) – o Configuration (note 9) – o Low Layer Information layer 1 info – o layer 2 info – o layer 3 info – o	Low layer compatibility – O – o
CT Connection Type – Circuit Mode Bearer: Suitable for speech	(note 4) – M Information transfer capacity: speech – m High layer compatibility – o Low layer compatibility – o Information transfer mode: circuit – m Information transfer rate: 64 kbit/s – m Establishment (note 9) – o Symmetry (note 9) – o Configuration (note 9) – o Encoding (μ- or A-Law) – m	Low layer compatibility – O – o

continued...

Table 2 – Detailed information content of SETUP (concluded)

Service element	Request/Indication	Response/Confirmation
CT Connection Type – Circuit Mode Bearer: Usable for 3,1 kHz audio	(note 4) – M Information transfer capacity: 3,1 kHz Audio – m High layer compatibility – o Low layer compatibility – o Information transfer mode: circuit – m Information transfer rate: 64 kbit/s – m Establishment (note 9) – o Symmetry (note 9) – o Configuration (note 9) – o Encoding (μ- or A-Law) – m	Low layer compatibility – O – o
DS Destination Subaddress	– O Subaddress – m Type of subaddress – m	–
CS Connected Subaddress	–	– O Subaddress – m Type of subaddress – m
OS Originating Subaddress	– O Subaddress – m Type of subaddress – m	–
CI Channel Identifier	(note 5) – M	–
CH Call History	– O Interworking with a public network (note 6) – o Signalling interworking: trunk release conditions (note 11) – o Signalling interworking: non-common channel signalling system (note 12) – o	– O Interworking with a public network (note 6) – o Signalling interworking: trunk release conditions (note 11) – o Signalling interworking: non-common channel signalling system (note 12) – o

NOTES to tables 1 and 2.

1. The SETUP request/indication across r3 shall contain DN where there is more than one PISN number associated with the called PISN user's access, otherwise the use of DN is optional.
2. The SETUP response/confirmation across r3 shall contain CN, where there is more than one PISN number associated with the called user's access, and the connected number differs from the destination number, otherwise the use of CN is optional. The SETUP response/confirmation across r2 shall contain CN except in the cases of interworking where it is not available.
3. The SETUP request/indication across r1 shall contain ON, where there is more than one PISN number associated with the calling PISN user's access, otherwise the use of ON is optional. The SETUP request/indication across r2 shall contain ON, except in the cases of interworking where it is not available.
4. The support of individual Bearer Capabilities is a network option.
5. When used within SETUP_request/indication, the "Channel Identifier" service element may have the four values: "preferred channel"; "exclusive channel"; "no channel", and "any free channel".
6. The "Interworking with a public network" parameter is relevant in SETUP_request/indication across r2 and r3 and in SETUP_response/confirmation across r1 and r2.
7. This parameter may be present if the number is known to be complete.
8. The number may not be available due to interworking.
9. Only the default values specified in clauses 6.6, 7.6 and 8.6 of these service parameters are supported.
10. During an interim period, some other networks may only support restricted 64 kbit/s digital information transfer capability. It shall be possible to indicate a restricted 64 kbit/s digital information transfer capability for interworking with such a network.
11. There are 3 values for the "Signalling interworking - trunk release conditions" parameter: "no release"; "no release before answer"; and, "no release after answer". If this parameter is present but not supported, the call should be cleared. This parameter is relevant only across r2.
12. There are 4 values for the "Signalling interworking - non-common channel signalling system" parameter: "call is not end-to-end ISDN, further call progress information may be available in-band"; "destination address is non-ISDN"; "origination address is non-ISDN"; and "call has returned to the ISDN". This parameter is relevant in SETUP_request/indication across r2 and r3 and in SETUP_response/confirmation across r1 and r2. Some values are relevant only in one direction, i.e., in SETUP_request/indication or in SETUP_response/confirmation.

13.3 REPORT

A functional entity shall use the REPORT information flow to convey information relating to the progress of a call through the network. This information flow is not confirmed and may be used within relationships r1, r2 and r3. REPORT shall convey the service elements that are shown in table 3. The detailed contents of these service elements are shown in table 4.

Table 3 – Information content of REPORT

Service element	Relationship	Request/Indication
RT Report Type	r1, r2, r3	(note) – M
CH Call History	r2, r1	– O
CC Clearing Cause	r1, r2	(note) – O
NOTE — Clearing Cause shall only be used in conjunction with the RT (Report Type) "Call Rejection", and it is then mandatory.		

Table 4 – Detailed information content of REPORT

Service element	Request/Indication
RT Report Type	(note 1) – M
CH Call History	– O In-band information – o Interworking with a public network (note 2) – o Signalling interworking: trunk release conditions (note 4) – o Signalling interworking: non-common channel signalling system (note 5) – o
CC Clearing Cause	(note 3) – O
NOTES	
<ol style="list-style-type: none"> 1. RT may have three values: “User being alerted”; “interworking encountered”; and “call rejection”. 2. The "Interworking with a public network" parameter is relevant across r1 and r2. 3. The service element CC shall only be used in conjunction with “call rejection”. “Call rejection” shall only be used over r1 and r2. 4. There are 3 values for the "Signalling interworking - trunk release conditions" parameter: "no release"; "no release before answer"; and, "no release after answer". If this parameter is present but not supported, the call should be cleared. This parameter is relevant only across r2. 5. There are 3 values for the "Signalling interworking - non-common channel signalling system" parameter: "call is not end-to-end ISDN, further call progress information may be available in-band"; "destination address is non-ISDN"; and "call has returned to the ISDN". This parameter is relevant only across r1 and r2. 	

13.4 CHANNEL_ACKNOWLEDGE

A functional entity shall use the CHANNEL_ACKNOWLEDGE information flow to confirm the channel allocation requested in the SETUP information flow. It may appear within relationships r1, r2 and r3. CHANNEL_ACKNOWLEDGE shall convey the service element that is shown in table 5.

Table 5 – Information content of CHANNEL_ACKNOWLEDGE

Service element	Relationship	Request/Indication
CI Channel Identifier	r1, r2, r3	(note) – M
NOTE — The “Channel Identifier” service element when used within CHANNEL_ACKNOWLEDGE_request/indication may have two values: “allocated channel” and “no channel”. The latter shall only be used over r3.		

13.5 CHANNEL_CONNECT

A functional entity shall use the CHANNEL_CONNECT information flow to indicate to a terminal competing for an incoming call, that it has been awarded the call, and that the terminal can connect to the agreed channel. CHANNEL_CONNECT shall be used over r3 only. The CHANNEL_CONNECTION information flow need not carry additional information.

13.6 DISCONNECT

A functional entity shall use the DISCONNECT information flow to invite the release of a connection across relationships r1 and r3. DISCONNECT shall convey the service element that is shown in table 6.

Table 6 – Information content of DISCONNECT

Service element	Relationship	Request/Indication
CC Clearing Cause	r1, r3	– M

13.7 RELEASE

A functional entity shall use the RELEASE information flow for freeing the resources associated with the call/connection, (such as call references and channels). This is a confirmed information flow. The responding part of RELEASE shall confirm that all resources previously associated with the connection have been freed. It may be used within relationships r1, r2 and r3. RELEASE shall convey the service element that is shown in table 7.

Table 7 – Information content of RELEASE

Service element	Relationship	Request/Indication	Response/Confirmation
CC Clearing Cause	r1, r2, r3	(note) – O	–
NOTE — Mandatory, if no previous DISCONNECT, otherwise optional.			

13.8 INFORMATION

A functional entity shall use the INFORMATION information flow to convey additional address information over r1 and r2 after SETUP has been sent. It is an unconfirmed information flow. INFORMATION shall convey the service elements that are shown in table 8.

Table 8 – Information content of INFORMATION

Service element	Relationship	Request/Indication
DN Destination Number	r1, r2	– M
NC Number complete indication	r1, r2	(note) – O
NOTE — “Number complete” shall only be sent when the FE has determined that the last digit of DN has been received.		

13.9 SETUP_REJECT

A functional entity shall send a SETUP_REJECT information flow over a single r1, r2 or r3 relationship to reject a SETUP_indication that it has received, but for some reason it cannot successfully process. It is an unconfirmed information flow. SETUP_REJECT shall convey the service element that is shown in table 9.

Table 9 – Information content of SETUP_REJECT

Service element	Relationship	Request/indication
CC Clearing Cause	r1, r2, r3	– M

13.10 PROCEEDING

A functional entity shall use the PROCEEDING information flow (when using digit-by-digit signalling) to indicate that all address information has been received, and that the call is being processed by the subsequent CCs. It is used in the relationships r1 and r2. For some calls other information flows (e.g., SETUP_response/confirmation) may convey the information included in PROCEEDING. PROCEEDING may convey the service element that is given in table 10.

Table 10 – Information content of PROCEEDING

Service element	Relationship	Request/Indication
CI Channel Identifier	r1, r2	– O

14 Information flow sequences

Below are information flow sequences that shall be taken into account during the detailed specification of Stage 3. These sequences constrain the Stage 3 to the extent that is required in order to guarantee inter-operability between different implementations. In particular the diagrams shown in clauses 14.2 to 14.11 are typical cases representing the most important information flow sequences.

The information flows that are shown in the r2* relationship are informative.

NOTE 51

In this clause, the terms “backward” and “forward” are used. At a particular functional entity the direction towards the Originating PISN user is called the “Backward” direction. The direction towards the Destination PISN user is called the “Forward” direction.

14.1 Functional entity actions

The functional entities that are applicable to these particular information flow sequences shall have the capabilities described below. The particulars of the information in the primitives between the CCA functional entities and the PISN users is beyond the scope of this Standard.

14.1.1 Originating CCA functional entity

- Function 000 – The SETUP_request primitive from the Originating PISN user’s request for service is processed, and the r1_SETUP_request is formulated and sent to the Originating CC functional entity.
- Function 001 – The r1_CHANNEL_ACKNOWLEDGE_indication is processed and the allocated channel is connected and cut-through to the PISN user, at least in the backward direction.
- Function 002 – The r1_REPORT_indication is processed. Because the incoming RT (Report Type) is “alerting”, a REPORT_indication primitive marked as alerting is sent to the Originating PISN user. The allocated channel should then be connected and cut-through to the PISN user at least in the backward direction, if not already done.
- Function 003 – The r1_SETUP_confirmation is processed and the allocated channel is connected and cut through to the PISN user in both directions, if not already done. A SETUP_confirmation primitive is sent to the Originating PISN user.
- Function 006 – The r1_REPORT_indication is processed. As the incoming REPORT contains Report Type “Call Rejection”, and Call History “In-Band Information”, a REPORT_indication primitive marked as “call rejection” is sent to the Originating PISN user. The allocated channel is then connected and cut-through to the PISN user in the backward direction, if not already done.
- Function 007 – The r1_REPORT_indication is processed. As the incoming REPORT contains Report Type “interworking encountered”, and Call History “In-Band Information”, a REPORT_indication primitive marked as “interworking” is sent to the Originating PISN user. The allocated channel is then connected and cut-through to the PISN user in the backward direction, if not already done.

- Function 010 – The r1_DISCONNECT_indication is processed; and a RELEASE_indication primitive is formulated and sent to the Originating PISN user.
- Function 011 – The RELEASE_response primitive from the Originating PISN user is processed, and a r1_RELEASE_request is formulated and sent to the Originating CC functional entity.
- Function 012 – The r1_RELEASE_confirmation is processed and the resources are released.
- Function 015 – The INFORMATION_request primitive is processed and a r1_INFORMATION_request is sent to the Originating CC functional entity.
- Function 016 – The r1_PROCEEDING_indication is processed. A REPORT_indication primitive marked as "call proceeding" is sent to the Originating PISN user.

14.1.2 Originating CC functional entity

- Function 100
 - a) The r1_SETUP_indication is processed.
 - b) The incoming information channel is reserved and a r1_CHANNEL_ACKNOWLEDGE_request is sent to the Originating CCA functional entity.
 - c) An outgoing information channel is reserved, based on the Destination Number and Connection Type information in the r1_SETUP_indication.

NOTE 52

The selection can also be dependant upon other information beyond the scope of this Standard.

- d) The r2_SETUP_request is generated and sent. The Originating Subaddress, the Destination Subaddress, or the Connection Type parameters, Low Layer Compatibility and High Layer Compatibility contained in the r1_SETUP_request, are carried in the r2_SETUP_request unchanged. The Originating Number in the r1_SETUP_request is screened at the CC functional entity. If the Originating Number is determined to be one of the numbers assigned to r1, the CC functional entity uses this Originating Number and classifies it "USER PROVIDED, VERIFIED AND PASSED". If no Originating Number is provided or it is determined not to be part of the set of multiple numbers assigned to that access, the CC functional entity provides a pre-arranged default Originating Number classified as "NETWORK PROVIDED". For the format and type of number see ISO/IEC 11571.
- Function 101 – The r2_CHANNEL_ACKNOWLEDGE_indication is processed and the allocated channel should be connected and cut-through in the backward direction. The information channel may also be cut-through in the forward direction.
 - Function 102 – The r2_REPORT_indication from the subsequent CC functional entity is processed. As the incoming REPORT contains Report Type "alerting", a r1_REPORT_indication marked as alerting is sent to the Originating CCA functional entity. The allocated channel should then be connected and cut-through in the backward direction, if not already done.
 - Function 103 – The r2_SETUP_confirmation is processed and the information channel shall be cut-through in both directions, if not cut-through already. A r1_SETUP_response is generated and then sent to the Originating CCA functional entity. The Connection Type parameter, contained in the r2_SETUP_confirmation is carried in the r2_SETUP_response unchanged.
 - Function 106 – The r2_REPORT_indication from the subsequent CC functional entity is processed. As the incoming REPORT contains Report Type "call rejection", and Call History "In-Band Information", a r1_REPORT_indication marked as "Call Rejection" is sent to the Originating CCA functional entity. The information channel should then be connected and cut-through in the backward direction, if not already done.
 - Function 107 – The r2_REPORT_indication is processed. As the incoming REPORT contains Report Type "interworking encountered", and Call History "In-Band Information", a r1_REPORT_request marked as "interworking" is sent to the Originating CCA. The allocated channel should then be connected and cut-through to the PISN user in the backward direction, if not already done.

- Function 110
 - a) The r2_RELEASE_indication is processed.
 - b) A r2_RELEASE_response is formulated and sent to the subsequent CC functional entity.
 - c) A r1_DISCONNECT_request is formulated and sent to the Originating CCA functional entity, and the resources are disconnected.
 - d) The resources are released in the direction of the subsequent CC functional entity.

NOTE 53

This Standard does not exclude the possibility of additional implementation procedures that do not result in the call being released, e.g., alternate routing.

- Function 111 – The r1_RELEASE_indication from the Originating CCA functional entity is processed. A r1_RELEASE_response is sent to the Originating CCA functional entity, and the resources are released in the direction of the Originating CCA functional entity.
- Function 112
 - a) The r1_SETUP_indication is processed.
 - b) The incoming information channel is reserved.
 - c) A r1_CHANNEL_ACKNOWLEDGE_request is sent to the Originating CCA functional entity.
- Function 113 – The r1_INFORMATION_indication is received and analysed. Check whether an outgoing setup is possible.
- Function 115 – The r1_INFORMATION_indication is processed and a r2_INFORMATION_request is sent to the Subsequent CC functional entity.
- Function 116
 - a) The r1_INFORMATION_indication is received and analysed.
 - b) Check whether outgoing call setup is possible.
 - c) The r2_SETUP_request is generated and sent. The Originating Subaddress, the Destination Subaddress, or the Connection Type parameters, Low Layer Compatibility and High Layer Compatibility contained in the r1_SETUP_request, are carried in the r2_SETUP_request unchanged. The Originating Number in the r1_SETUP_request is screened at the CC functional entity. If the Originating Number is determined to be one of the numbers assigned to r1, the CC functional entity uses this Originating Number and classifies it “USER PROVIDED, VERIFIED AND PASSED”. If no Originating Number is provided or it is determined not to be part of the set of multiple numbers assigned to that access, the CC functional entity provides a pre-arranged default Originating Number classified as “NETWORK PROVIDED”. For the format and type of number see ISO/IEC 11571.
- Function 117 – The r2_PROCEEDING_indication is processed. A r1_PROCEEDING_request is sent to the Originating CCA.

14.1.3 Transit CC functional entity

- Function 200
 - a) The r2_SETUP_indication is processed.
 - b) The incoming information channel is reserved and a r2_CHANNEL_ACKNOWLEDGE_request is sent.
 - c) An outgoing information channel is reserved, based on the Destination Number (DN) and Connection Type (CT) information in the r2_SETUP_indication.

NOTE 54

The selection can also be dependant upon other information beyond the scope of this Standard.

- d) The r2_SETUP_request is generated and sent. The Originating Number, Originating Subaddress, Destination Subaddress, Call History information and the Connection Type parameters, Low Layer Compatibility and High Layer Compatibility, contained in the r2_SETUP_indication, are carried in the r2_SETUP_request.
- Function 201 – The r2_CHANNEL_ACKNOWLEDGE_indication is processed and the allocated channel is connected and cut-through in the backward direction; the information channel may also be cut-through in the forward direction.
 - Function 202 – The r2_REPORT_indication is processed. As the incoming REPORT contains Report Type “alerting”, a r2_REPORT_request marked as “alerting”, is sent to the preceding CC functional entity. The allocated channel should then be connected and cut-through in the backward direction, if not already done.
 - Function 203 – The r2_SETUP_confirmation is processed and the information channel is cut-through in the forward direction, if not cut-through already. A r2_SETUP_response is generated and then sent to the preceding CC functional entity. The Connected Number, Connected Subaddress, or the Connection Type parameter, contained in the r2_SETUP_confirmation, are carried in the r2_SETUP_response.
 - Function 206 – The r2_REPORT_indication is processed. As the incoming REPORT contains Report Type “call rejection”, and Call History “In-Band Information”, a r2_REPORT_request marked as “Call Rejection” is sent to the preceding CC functional entity. The information channel is then connected and cut-through in the backward direction, if not already done.
 - Function 207 – The r2_REPORT_indication is processed. As the incoming REPORT contains Report Type “interworking encountered”, and Call History “In-Band Information”, a r2_REPORT_request marked as “interworking” is sent to the preceding CC. The allocated channel is then connected and cut-through to the PISN user in the backward direction, if not already done.
 - Function 210
 - a) The r2_RELEASE_indication is processed.
 - b) A r2_RELEASE_response is formulated and sent to the subsequent CC functional entity.
 - c) A r2_RELEASE_request is formulated and sent to the preceding CC functional entity; and the resources are disconnected, and then released in the direction of the subsequent CC functional entity.

NOTE 55

This Standard does not exclude possible implementation specific procedures that do not result in the call being released, e.g., alternate routing.

- Function 211 – The r2_RELEASE_confirmation from the preceding CC functional entity is processed, and the resources are released in the direction of the preceding CC functional entity.
- Function 216
 - a) The r2_INFORMATION_indication is received and analysed.
 - b) Formulate and send r2_INFORMATION_request with a “number complete” indication.
 - c) Send r2_PROCEEDING_request to Originating CC functional entity.

14.1.4 Destination CC functional entity

- Function 300
 - a) The r2_SETUP_indication is processed.
 - b) The incoming information channel is reserved and a r2_CHANNEL_ACKNOWLEDGE_request is sent.
 - c) An outgoing information channel is reserved, based on the Destination Number (DN) and Connection Type (CT) information in the r2_SETUP_indication.

NOTE 56

The selection can also be dependant upon other information beyond the scope of this Standard.

- d) The r3_SETUP_request is generated and sent. The Destination Subaddress, Call History information or the Connection Type parameters, Low Layer Compatibility or High Layer Compatibility contained in the incoming r2_SETUP_indication are carried in the r3_SETUP_request.
- Function 301 – The r3_CHANNEL_ACKNOWLEDGE_indication is processed and the allocated channel is reserved.
- Function 302 – The r3_REPORT_indication from the Destination CCA functional entity is processed. As the incoming REPORT contains Report Type “alerting”, a r2_REPORT_request marked as “alerting” is sent to the preceding CC functional entity. If the Bearer service requested was Speech, or 3,1 kHz, then Ring tone is applied towards the Originating CCA functional entity.
- Function 303
 - a) The r3_SETUP_confirmation is processed. If Ring Tone had been applied towards the Originating CCA functional entity it is removed.
 - b) The information channel is connected and cut-through in both forward and backward directions.
 - c) A r2_SETUP_response is generated and then sent to the preceding CC functional entity. The Connected Number, Connected Subaddress, and the Connection Type parameters, contained in the r3_SETUP_confirmation, are carried in the r2_SETUP_response. The Connected Number is screened by the CC functional entity. If the Connected Number is determined to be one of the numbers assigned to that access, the CC functional entity uses this Connected Number and classifies it “USER PROVIDED, VERIFIED AND PASSED”. If the Connected Number is provided and it is determined not to be part of the set of multiple numbers assigned to that access, the CC functional entity provides a pre-arranged default Connected Number classified as “NETWORK PROVIDED”. For the format and type of number see ISO/IEC 11571.
 - d) Also a r3_CHANNEL_CONNECT_request is generated and sent to the Destination CCA functional entity. In the case where more than one CCA functional entity has responded, the CC functional entity shall release all the CCA functional entities other than the one that has been awarded the call.
- Function 310
 - a) The r3_DISCONNECT_indication is processed.
 - b) A r3_RELEASE_request is formulated and sent to the Destination CCA functional entity.
 - c) A r2_RELEASE_request is formulated and sent to the preceding CC functional entity.
 - d) The resources are disconnected.
- Function 311 – The r3_RELEASE_confirmation from the Destination CCA functional entity is processed; and the resources are released in the direction of the Destination CCA functional entity.
- Function 312 – The r2_RELEASE_confirmation from the preceding CC functional entity is processed; and the resources are released in the direction of the preceding CC functional entity.
- Function 314
 - a) The r2_SETUP_indication is processed.
 - b) The incoming information channel is reserved and a r2_CHANNEL_ACKNOWLEDGE_request is sent.
- Function 315
 - a) The r2_INFORMATION_indication is received and analysed.
 - b) An outgoing information channel is reserved, based on the Destination Number (DN) and Connection Type (CT) information in the r2_SETUP_indication.
 - c) The r3_SETUP_request is generated and sent. The Destination Subaddress, Call History information or the Connection Type parameters, Low Layer Compatibility or High Layer Compatibility contained in the incoming r2_SETUP_indication, are carried in the r3_SETUP_request.

- Function 320 – The r3_SETUP_REJECT_request is processed, and a r2_RELEASE_request is sent to the preceding CC functional entity. Resources are released in the direction of the Destination CCA.
- Function 321 – The r3_SETUP_REJECT_request is processed, and because the Destination CC wants to offer an in-band indication, a r2_REPORT_request is sent to the preceding CC. The in-band source is applied to the information channel.

14.1.5 Destination CCA functional entity

- Function 400
 - a) The r3_SETUP_indication is processed.
 - b) A r3_CHANNEL_ACKNOWLEDGE_request is sent.
 - c) The addressing and compatibility requirements contained within the r3_SETUP_indication are processed to ascertain if the call request should be passed to the PISN user. The information within the r3_SETUP_indication that shall be checked is the Connection Type, Destination Number, Low Layer Compatibility, and High Layer Compatibility.
 - d) A SETUP_indication primitive is generated and sent to the PISN user.
- Function 401 – The REPORT_request primitive marked as alerting from the Destination PISN user is processed, and a r3_REPORT_request with a Report Type of “alerting” is sent to the Destination CC functional entity.
- Function 402 – The SETUP_response primitive from the Destination PISN user is processed, and a r3_SETUP_response is sent to the Destination CC functional entity. In this example the Connected Number, the Connected Subaddress, and the Connection Type parameters are carried in the r3_SETUP_response. The information channel is cut-through in the forward direction, if not cut-through already.
- Function 403 – The r3_CHANNEL_CONNECT_indication is processed and the information channel is cut-through in both the forward and backward directions.
- Function 410
 - a) The RELEASE_request primitive from the Destination PISN user is processed.
 - b) A r3_DISCONNECT_request is formulated and sent to the Destination CC functional entity.
 - c) The resources are disconnected.
- Function 411
 - a) The r3_RELEASE_indication from the Destination CC functional entity is processed.
 - b) A r3_RELEASE_response is sent to the Destination CC functional entity; and the resources are released.
 - c) A RELEASE_confirmation primitive is then sent to the Destination PISN user.
- Function 420
 - a) The RELEASE_request primitive from the Destination PISN user is processed.
 - b) A r3_SETUP_REJECT_request is sent to the Destination CC functional entity, and the resources are released in both directions.
 - c) A RELEASE_confirmation primitive is returned to the PISN user.

The r3_SETUP_REJECT_request/indication contains a CC service element.

14.1.6 Incoming gateway CC functional entity

The information flows at r2* are provided for information purposes only as they are outside the scope of this Standard.

- Function 130 – On receipt of an incoming call from the other network, an outgoing information channel is reserved, based on the Destination Number and Connection Type information that is available from the other

network. Then a r2_SETUP_request is sent to the subsequent CC functional entity. The r2_SETUP_request primitive contains an appropriate Call History parameter.

NOTE 57

The information flows between the CC functional entity and a non-ISDN are beyond the scope of this Standard.

- Function 131 – The r2_REPORT_indication marked as alerting from the subsequent CC functional entity is processed. The information channel should then be connected and cut-through in the backward direction, if not already done.

NOTE 58

The information flows between the CC functional entity and a non-ISDN are beyond the scope of this Standard.

- Function 132 – The r2_SETUP_confirmation is processed and the information channel is cut-through in the forward direction, if not cut-through already.

NOTE 59

The information flows between the CC functional entity and a non-ISDN are beyond the scope of this Standard.

- Function 140
 - a) The r2*_SETUP_indication is processed.
 - b) The incoming information channel is reserved and a r2*_CHANNEL_ACKNOWLEDGE_request is sent.
 - c) An outgoing information channel is reserved, based on the Destination Number (DN) and Connection Type (CT) information in the r2*_SETUP_indication. The selection may also be dependant upon other information beyond the scope of this Standard.
 - d) The r2_SETUP_request is generated and sent. If present, the Originating Number, Originating Subaddress, the Destination Subaddress, Call History information or the Connection Type parameters, Low Layer Compatibility and High Layer Compatibility contained in the incoming r2*_SETUP_indication are carried in the r2_SETUP_request.

NOTES

60. *The Originating Number can be obtained using the public ISDN supplementary service Calling Line Identification Presentation (CLIP), see ITU-T Rec. I.251.3.*

61. *The information flows between the CC functional entity and a public ISDN are beyond the scope of this Standard.*

- Function 141 – The r2_CHANNEL_ACKNOWLEDGE_indication is processed and the allocated channel is connected and cut-through in the backward direction. The information channel may also be cut-through in the forward direction.
- Function 142 – The r2_REPORT_indication is processed. As the incoming REPORT contains Report Type “alerting”, a r2*_REPORT_indication marked as an “Alerting” primitive is sent to the public ISDN. The allocated channel should then be connected and cut-through in the backward direction, if not already done.

NOTE 62

The information flows between the CC functional entity and a public ISDN are beyond the scope of this Standard.

- Function 143 – The r2_SETUP_confirmation is processed and the information channel is cut-through in the forward direction, if not cut-through already. A r2*_SETUP_response is generated and then sent to the public ISDN functional entity.

NOTE 63

The information flows between the CC functional entity and a public ISDN are beyond the scope of this Standard.

14.1.7 Outgoing gateway CC functional entity

The information flows at r2* are provided for information purposes only as they are outside the scope of this Standard.

- Function 330
 - a) The r2_SETUP_indication is processed.
 - b) The incoming information channel is reserved and a r2_CHANNEL_ACKNOWLEDGE_request is sent to the preceding CC functional entity.
 - c) An outgoing information channel is reserved, based on the Destination Number (DN) and Connection Type (CT) information in the r2_SETUP_indication.

NOTES

64. The selection can also be dependant upon other information beyond the scope of this Standard.

65. The information flows supported over the relationship with a non-ISDN are beyond the scope of this Standard.

- Function 331 – In this example when interworking with a non-ISDN Network a r2_REPORT is normally sent to the preceding CC functional entity with appropriate parameter in the CH service element indicating interworking. The event that causes the CC functional entity to send this information flow is beyond the scope of this Standard.
- Function 332 – For the call to be completed successfully the Gateway CC functional entity shall send a r2_SETUP_response to the preceding CC functional entity. The event that causes the CC functional entity to send this information flow is beyond the scope of this Standard.
- Function 335 – The r2_INFORMATION_indication is processed.

NOTE 66

The information flows supported over the relationship with a non-ISDN are beyond the scope of this Standard.

- Function 340
 - a) The r2_SETUP_indication is processed.
 - b) The incoming information channel is reserved and a r2_CHANNEL_ACKNOWLEDGE_request is sent.
 - c) An outgoing information channel is reserved based on the Destination Number (DN) and Connection Type (CT) information in the r2_SETUP_indication. The selection can also be dependant upon other information beyond the scope of this Standard.
 - d) The r2*_SETUP_request is generated and sent.

NOTE 67

The information flows between the CC functional entity and a public ISDN are beyond the scope of this Standard.

- Function 341 – The r2*_CHANNEL_ACKNOWLEDGE_indication is processed and the allocated channel is connected and cut-through in the backward direction; the information channel may also be cut-through in the forward direction.
- Function 342 – The r2*_REPORT_indication is processed. As the incoming REPORT contains Report Type “Alerting”, a r2_REPORT_indication marked as “alerting” is sent to the preceding CC functional entity. The allocated channel should then be connected and cut-through in the backward direction, if not already done.

NOTE 68

The information flows between the CC functional entity and a public ISDN are beyond the scope of this Standard.

- Function 343 – The r2*_SETUP_confirmation is processed and the information channel is cut-through in the forward direction, if not cut-through already. A r2_SETUP_response is generated and then sent to the preceding CC functional entity. In this example, the Connected Number, Connected Subaddress or the Connection Type parameter, contained in r2*_SETUP_confirmation are carried in the r2_SETUP_response.

NOTES

69. *The Connected Number can be obtained using the public ISDN service Connected Line Identification Presentation (COLP) supplementary service. (See ITU-T Rec. 251.5).*
70. *The information flows between the CC functional entity and a public ISDN are beyond the scope of this Standard.*

14.2 Normal call establishment

The information flow sequence for a successful call setup with en-bloc sending and with delayed answer by the destination CCA is shown in figure 6.

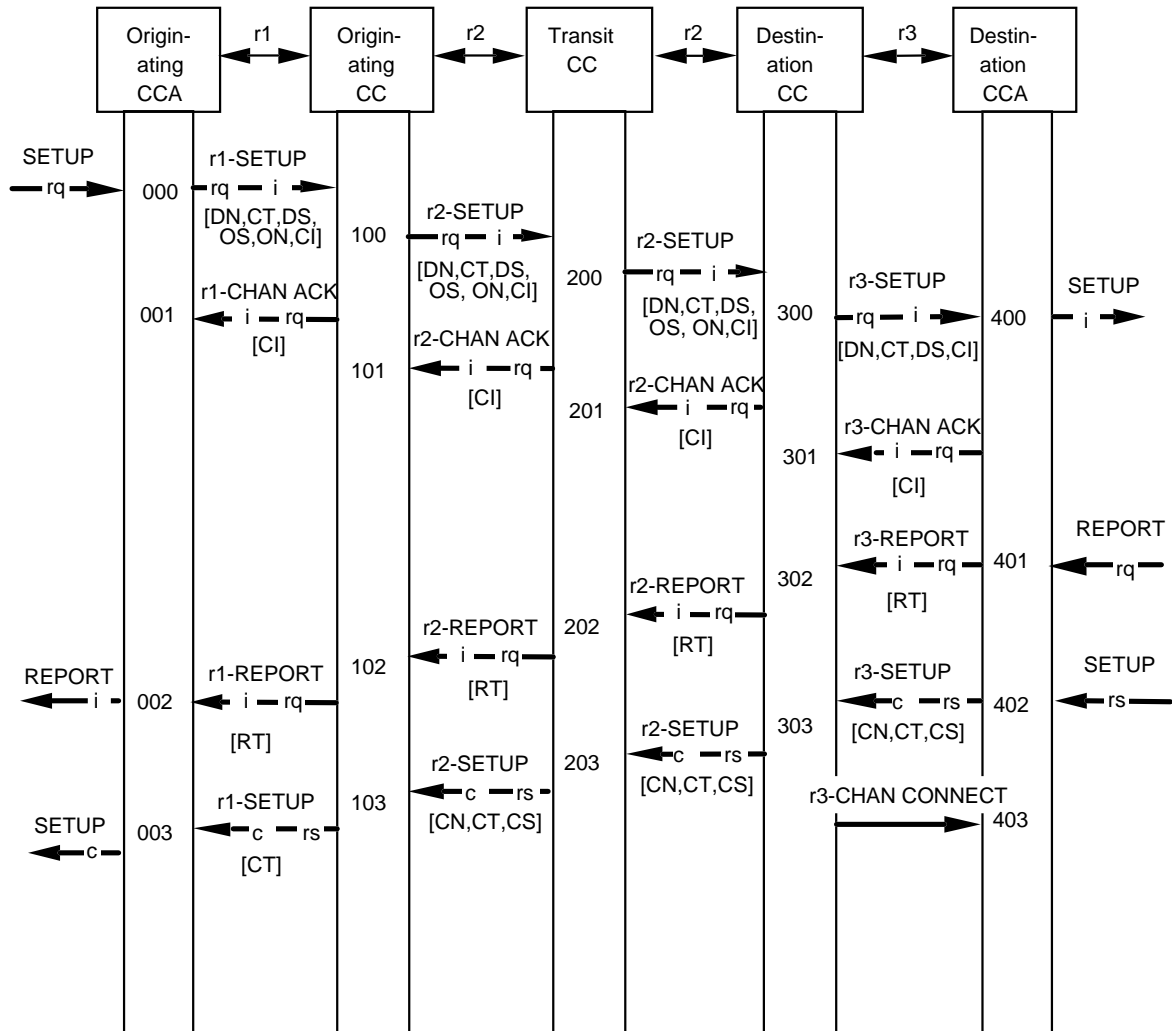

NOTES –

1. The Report Type (RT) in this sequence is "User being alerted".
2. This information flow sequence does not show interworking with non-ISDN terminals which are attached to the PISN.

Figure 6 – Normal call establishment with en-bloc signalling

14.3 Normal call establishment with digit-by-digit sending and automatic answer

The information flow sequence for a successful call setup with digit-by-digit sending and when a call attempt encounters a Destination CCA that immediately enters the call established state is shown in figure 7.

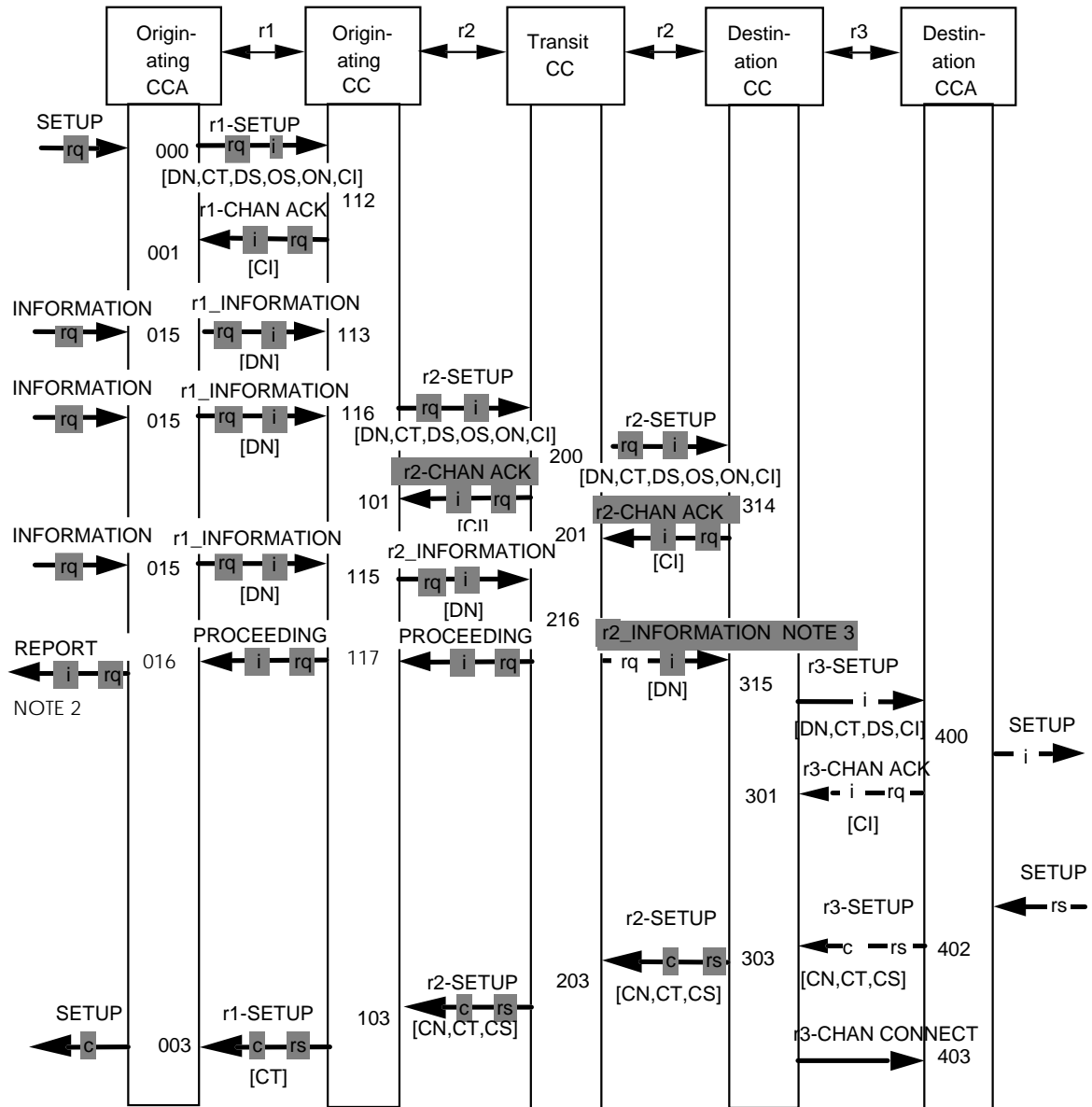

NOTES –

1. This information flow sequence does not show interworking with non-ISDN terminals which are attached to the PISN.
2. The Report Type (RT) is "call proceeding".
3. The INFORMATION flow contains the indicator "number complete".

Figure 7 – Normal call establishment with digit-by-digit sending and automatic answer

14.4 Unsuccessful calls with the provision of tones and announcements

The information flow sequence when a call attempt is unsuccessful and fails with the provision of in-band tones and announcements is shown in figure 8.

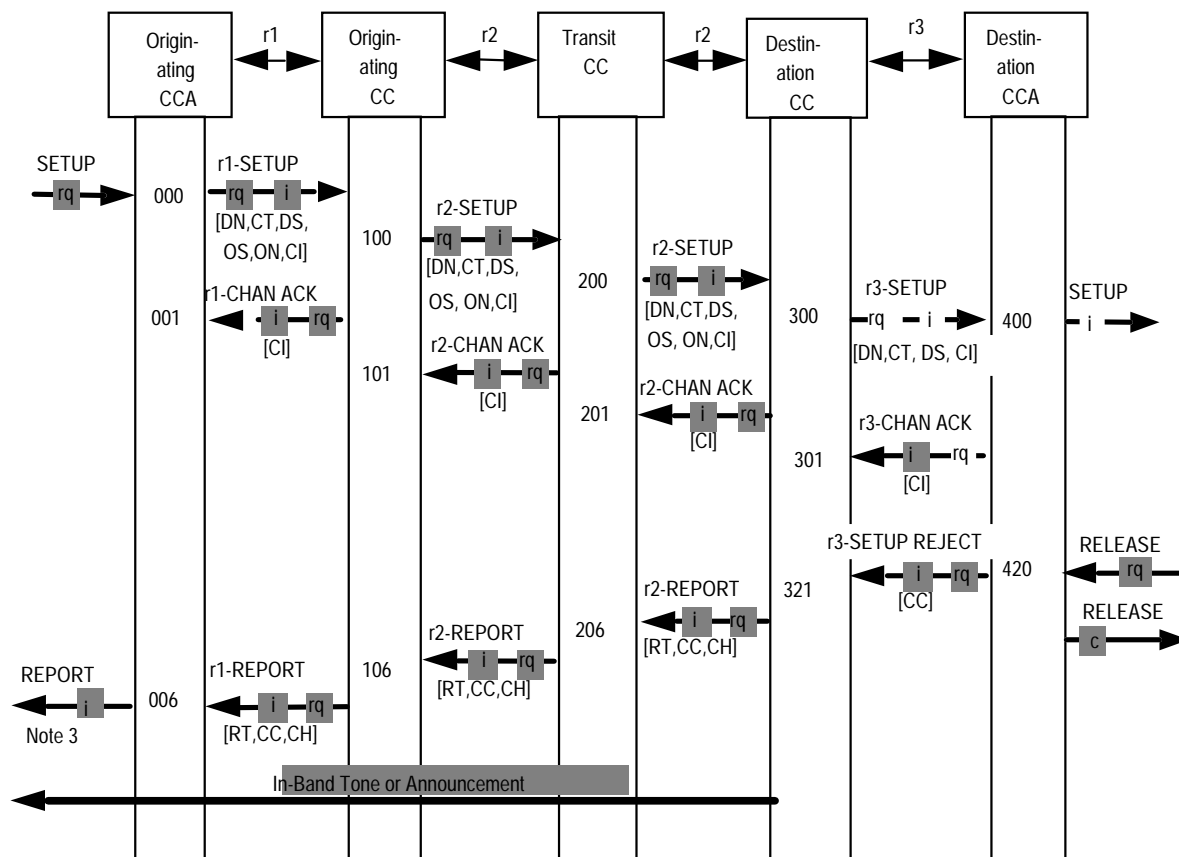

NOTES –

1. It is possible to clear the call from either end.
2. In this information flow sequence the source of the inband tone or announcement is collocated with a Destination CC functional entity. The particular location of the source of the inband tone or announcement depends on the network configuration, and is beyond the scope of this Standard.
3. The RT (Report Type) in this sequence is “Call Rejected”.
4. This information flow sequence does not show interworking with non-ISDN terminals which are attached to the PISN.

Figure 8 – Unsuccessful calls with the provision of tones and announcements

14.5 Unsuccessful calls without the provision of tones and announcements

The information flow sequence when a call attempt is unsuccessful and fails without the provision of in-band tones and announcements is shown in figure 9.

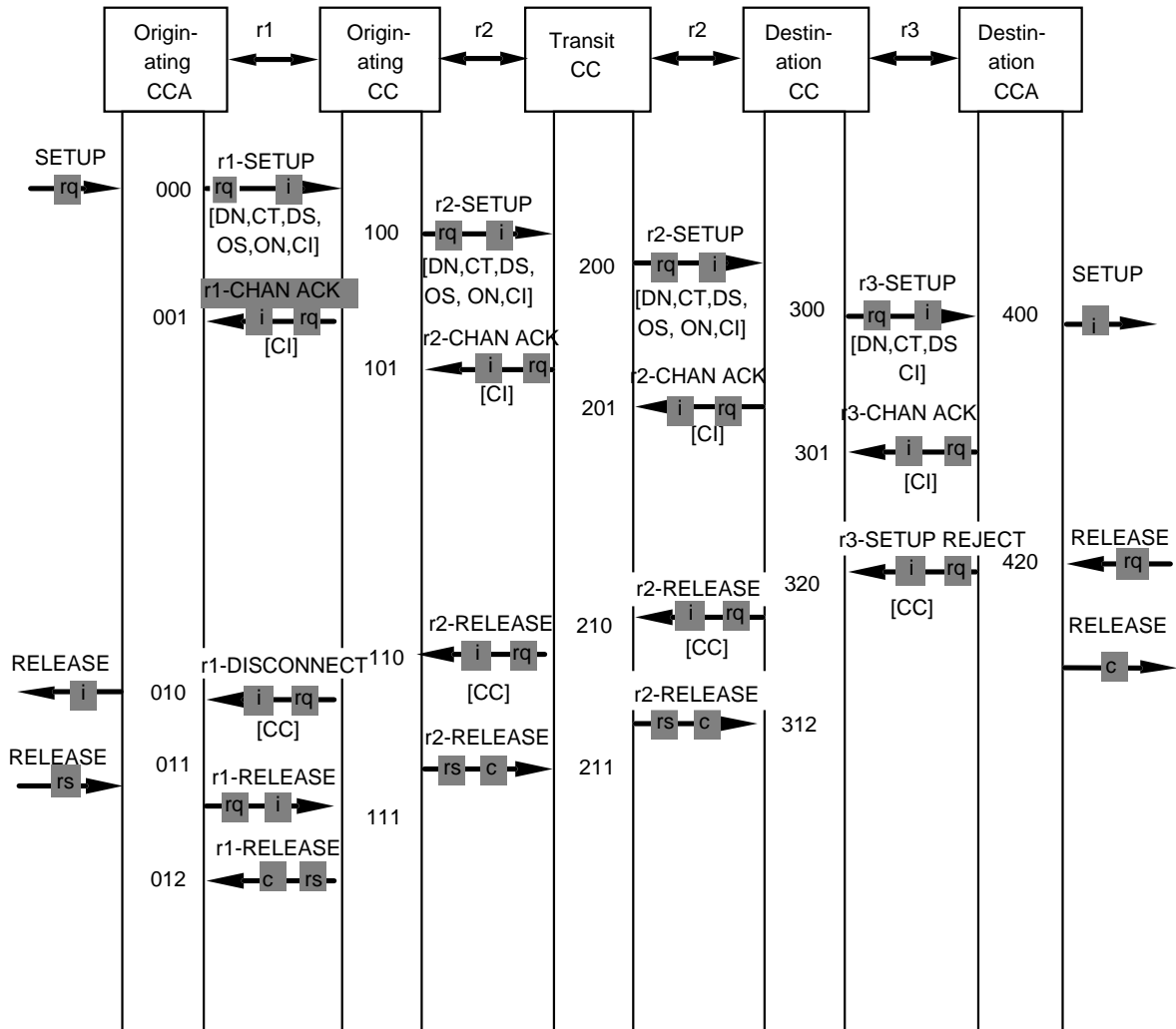

NOTE –

This information flow sequence does not show interworking with non-ISDN terminals which are attached to the PISN.

Figure 9 – Unsuccessful calls without the provision of tones and announcements

14.6 Incoming interworking with a non-ISDN

The information flow sequence when a call attempt from a non-ISDN interworks with the PISN is shown in figure 10.

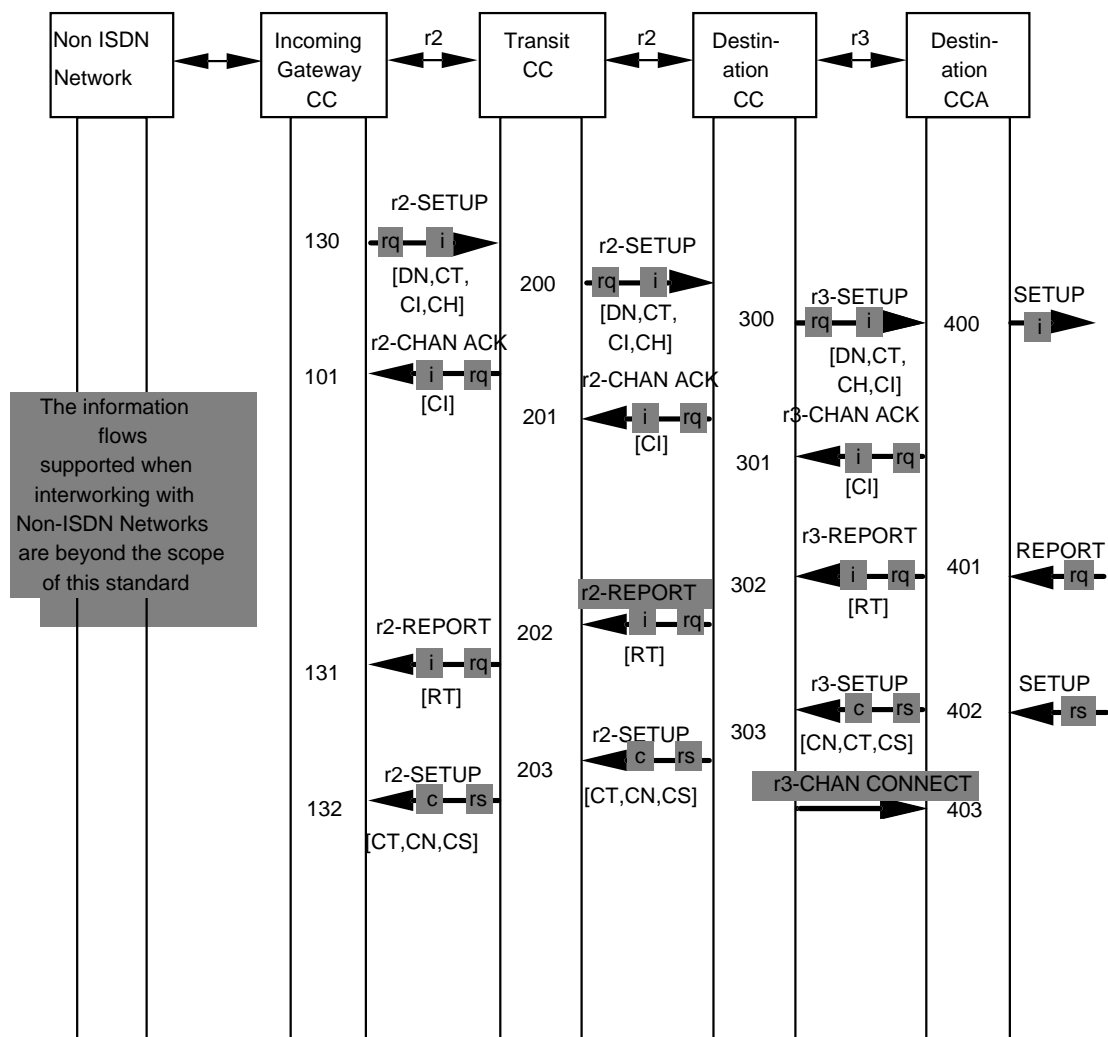

NOTE –

The RT (Report Type) in this sequence is “User being alerted”.

Figure 10 – Incoming interworking with a non-ISDN

14.7 Outgoing interworking with a non-ISDN

The information flow sequence when a call attempt from the PISN interworks with a non-ISDN is shown in figure 11.

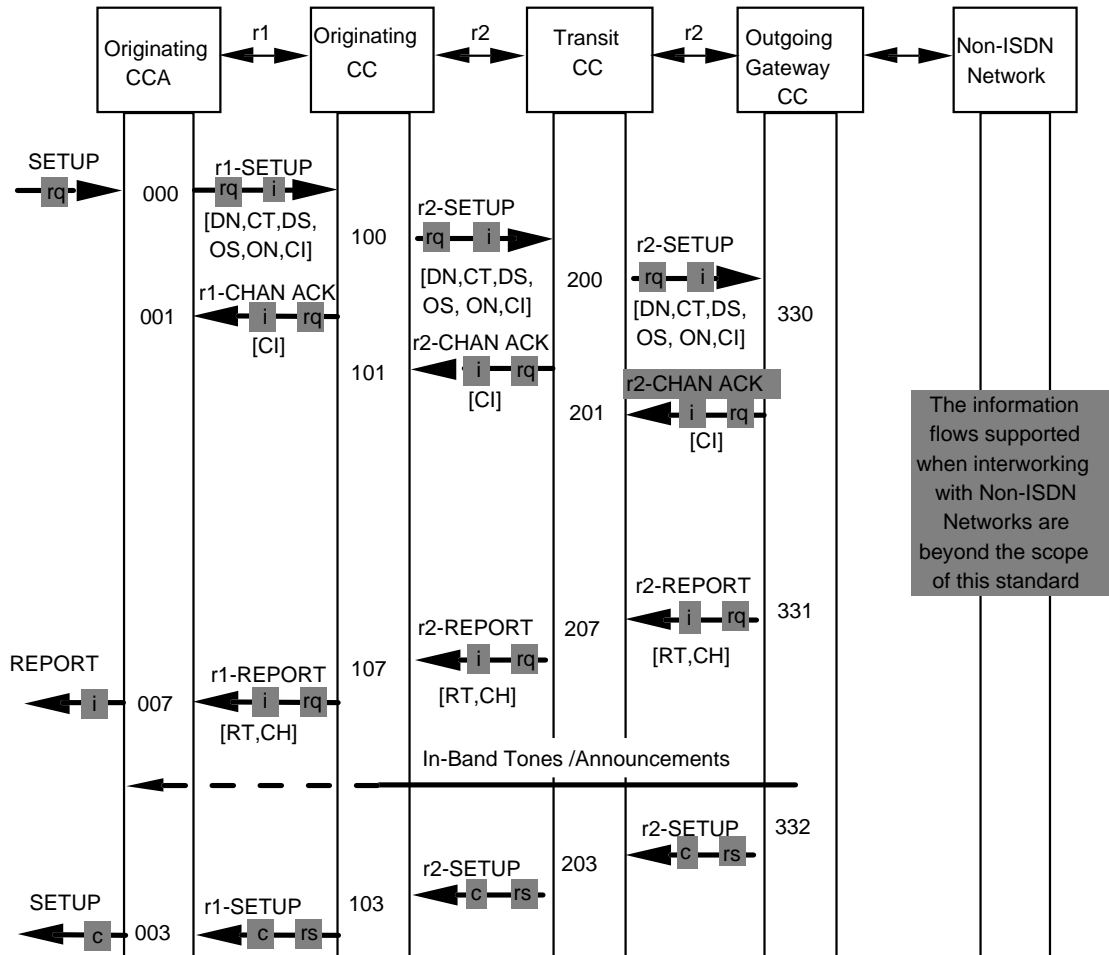

NOTES –

1. CH (Call History) in the REPORT_request/indication information flows contains the interworking with non-ISDN marker.
2. This sequence shows the scenario where the non-ISDN is unable to provide an indication of alerting or inband tones being applied.
3. The RT (Report Type) shown in this sequence is 'interworking encountered'.
4. This information flow sequence does not show interworking with non-ISDN terminals which are attached to the PISN.

Figure 11 – Outgoing interworking with a non-ISDN

14.8 Outgoing interworking with digit-by-digit sending

The information flow sequence when a call attempt using overlap sending from the PISN interworks with a non-ISDN is shown in figure 12.

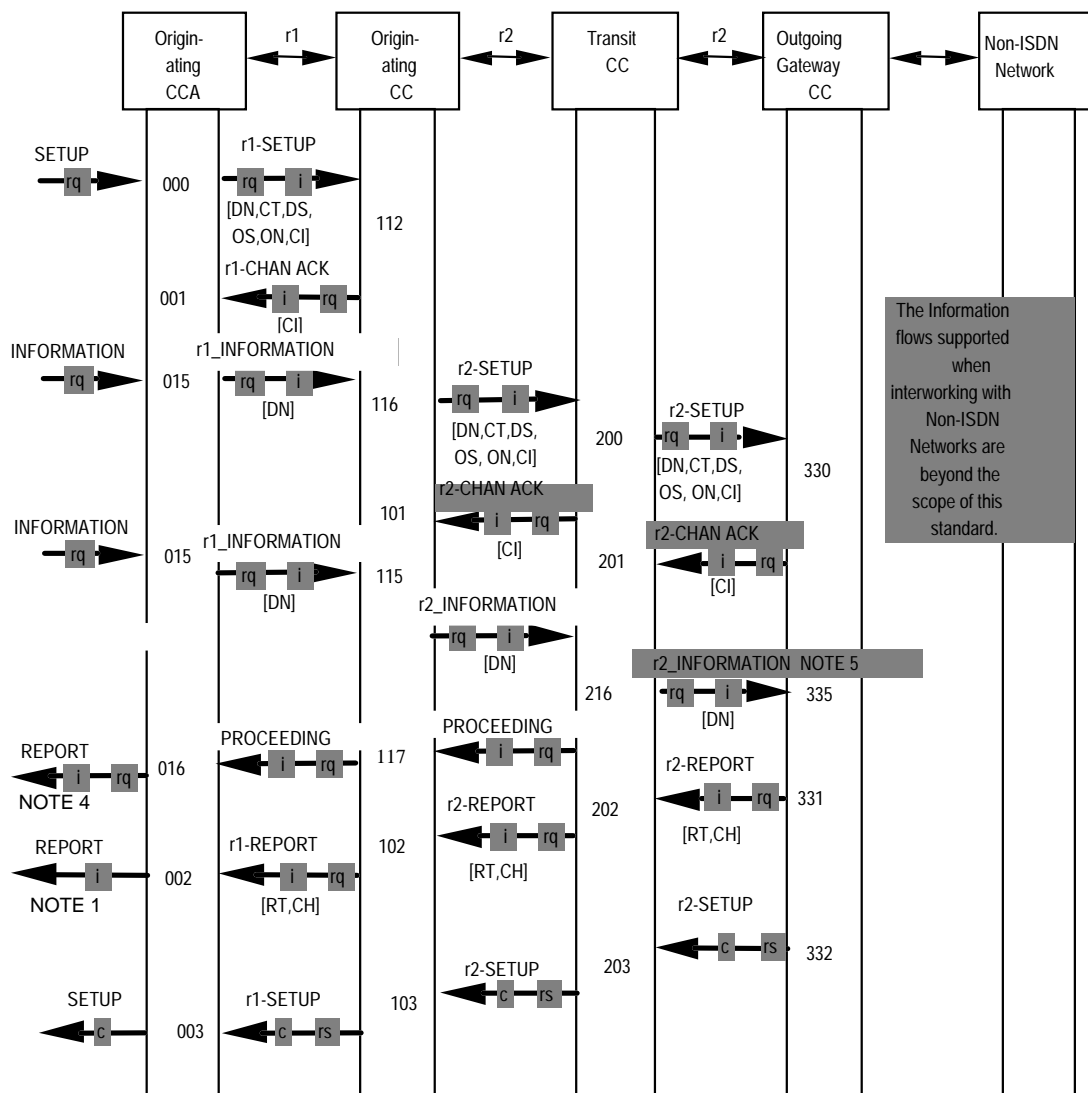

NOTES –

1. The RT (Report Type) shown in this sequence is 'interworking encountered'.
2. This information flow sequence does not show interworking with non-ISDN terminals which are attached to the PISN.
- 3 The digits may be provided by the user with several INFORMATION flows.
4. The Report Type is "call proceeding".
5. The INFORMATION flow contains the indicator "number complete".

Figure 12 – Outgoing interworking using digit-by-digit sending and with the length unknown by the Originating CC, and with interworking to a non-ISDN

14.9 Basic call clearing

The information flow sequence when a call is cleared is shown in figure 13.

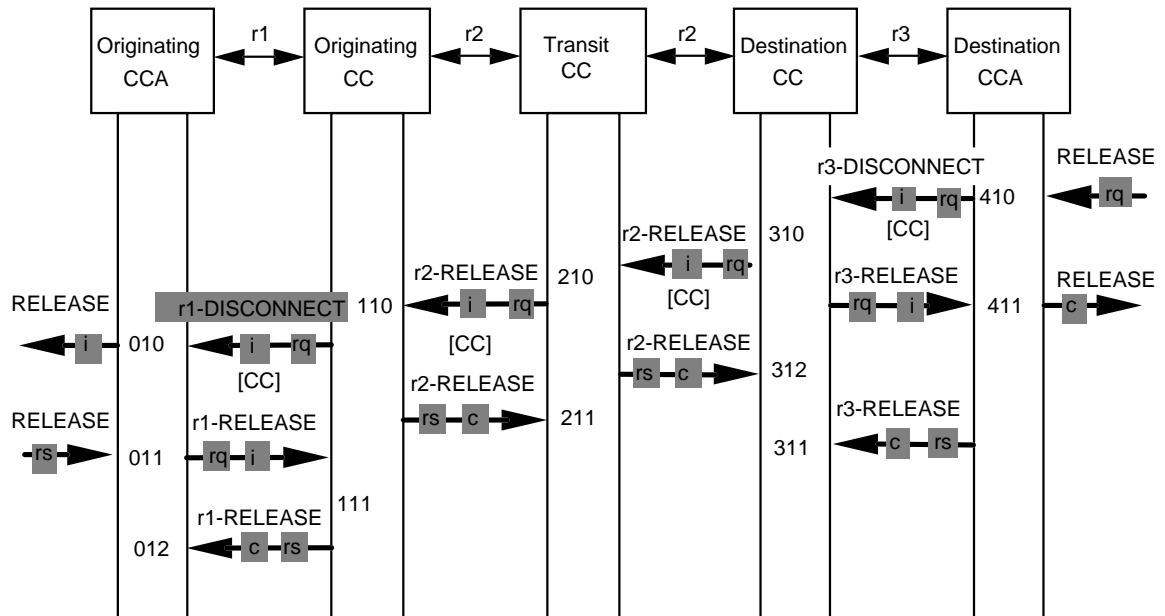

NOTE –

Three Stage Clearing is used on the r1/r3 that originates clearing as this allows for supplementary service information to be passed from the network to the extension (e.g. call charging). Three Stage Clearing is used on the r1/r3 that has not initiated clearing as this allows for symmetry to be maintained.

Figure 13 – Basic call clearing

14.10 Incoming interworking with a public ISDN

The information flow sequence when a call attempt from a public ISDN interworks with the PISN is shown in figure 14. The information flows of the r2* relationship are shown for information purposes only as they are beyond the scope of this Standard.

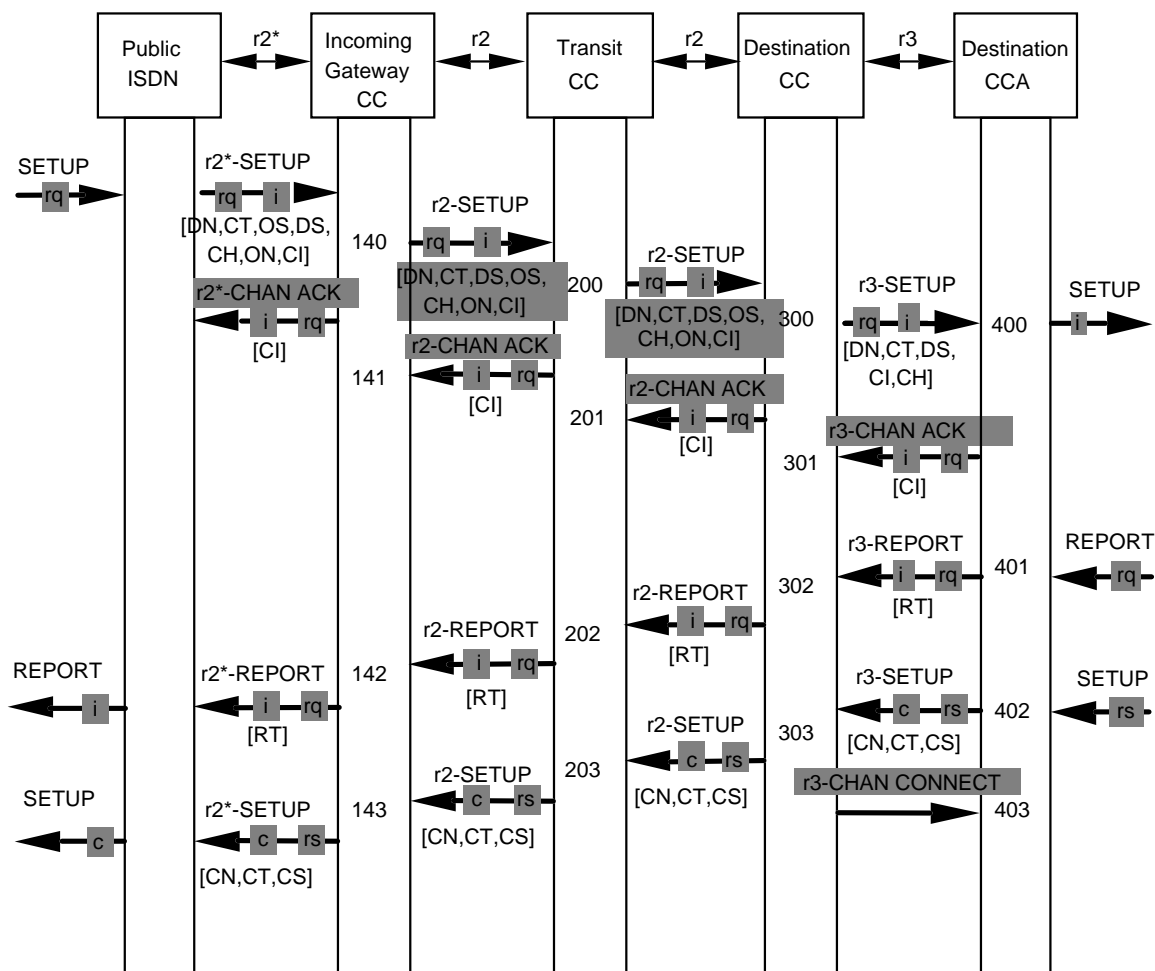

NOTES –

1. Call History contains the interworking with public network marker.
2. The r2* flows are informative.

Figure 14 – Incoming interworking with a public ISDN

14.11 Outgoing interworking with a public ISDN

The information flow sequence when a call attempt from the PISN interworks with a public ISDN is shown in figure 15. The information flows of the r2* relationship are shown for information purposes only as they are beyond the scope of this Standard.

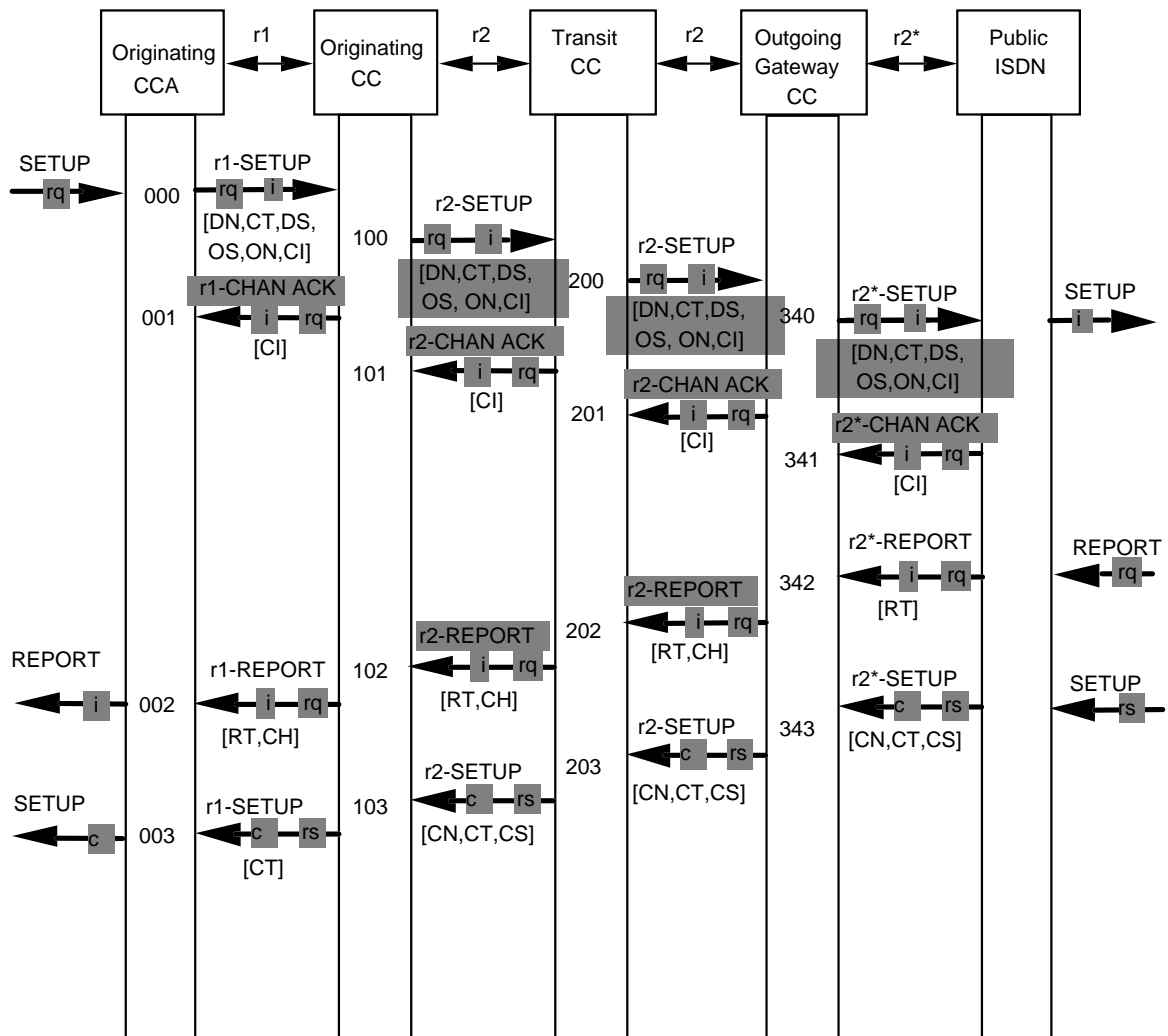

NOTES –

1. Call History contains the interworking with public network marker
2. The r2* flows are informative.

Figure 15 – Outgoing interworking with a public ISDN

15 SDL diagrams for functional entities

The FE functions which are shown in SDL form in this clause are intended to illustrate typical FE behaviour in terms of information flows sent and received.

The SDL diagrams are in five groups:

- Originating CCA functional entity SDL diagrams
- Originating CC functional entity SDL diagrams
- Transit CC functional entity SDL diagrams
- Terminating CC functional entity SDL diagrams
- Terminating CCA functional entity SDL diagrams

Only timers that can be considered as call control (i.e. not protocol timers) are shown.

NOTES

71. *In this clause the primitive and information flows are shortened: “request” to “req”; “indication” to “ind”; “response” to “resp”; and “confirmation” to “cfm”.*
72. *Also in this clause the terms “backward” and “forward” are used. At a particular functional entity the direction towards the Originating PISN user is called the “Backward” direction. The direction towards the Destination PISN user is called the “Forward” direction.*

15.1 Originating CCA functional entity SDL diagrams

Output signals to the left and input signals from the left represent primitives to and from the Originating PISN user. Output signals to the right and input signals from the right represent information flows across r1 to and from the Originating CC functional entity. The only exception to this rule is when the text within the signals explicitly identifies from what function the signal originates.

15.1.1 Originating CCA states used in SDL diagrams

- **Orig_CCA_Idle** - No Call in progress
- **Orig_CCA_Forward_Release_Forward_r1_Disconnect** - Originating PISN user has initiated clearing and the CCA is awaiting response from the originating CC to the request for clearing.
- **Orig_CCA_Backward_Release** - Clearing of the CCA channel has been indicated to the PISN user, clearing across r1 complete, awaiting response from the PISN user.
- **Orig_CCA_Wait_for_Release_Channel** - In-band tones/announcements being given to the PISN user, awaiting r1_release_cfm and PISN user or CCA originated clearing.
- **Orig_CCA_Call_Sent** - Call has been initiated by the CCA, the channel has been reserved to the Originating CC, and an end to end response is awaited.
- **Orig_CCA_Call_Initiated** - Call has been initiated by the CCA functional entity, and the CCA is awaiting a response from the Originating CC.
- **Orig_CCA_Call_Active** - Call is in active phase.
- **Orig_CCA_Backward_Release_Backward_r1_Disconnect** - Originating CC has initiated clearing and the CCA is awaiting response from the Originating PISN user to the request for clearing.
- **Orig_CCA_Forward_r1_Release** - Clearing of the CCA to CC channel has been initiated, PISN user clearing complete, awaiting response from the Originating CC.

15.1.2 Originating CCA SDL diagrams

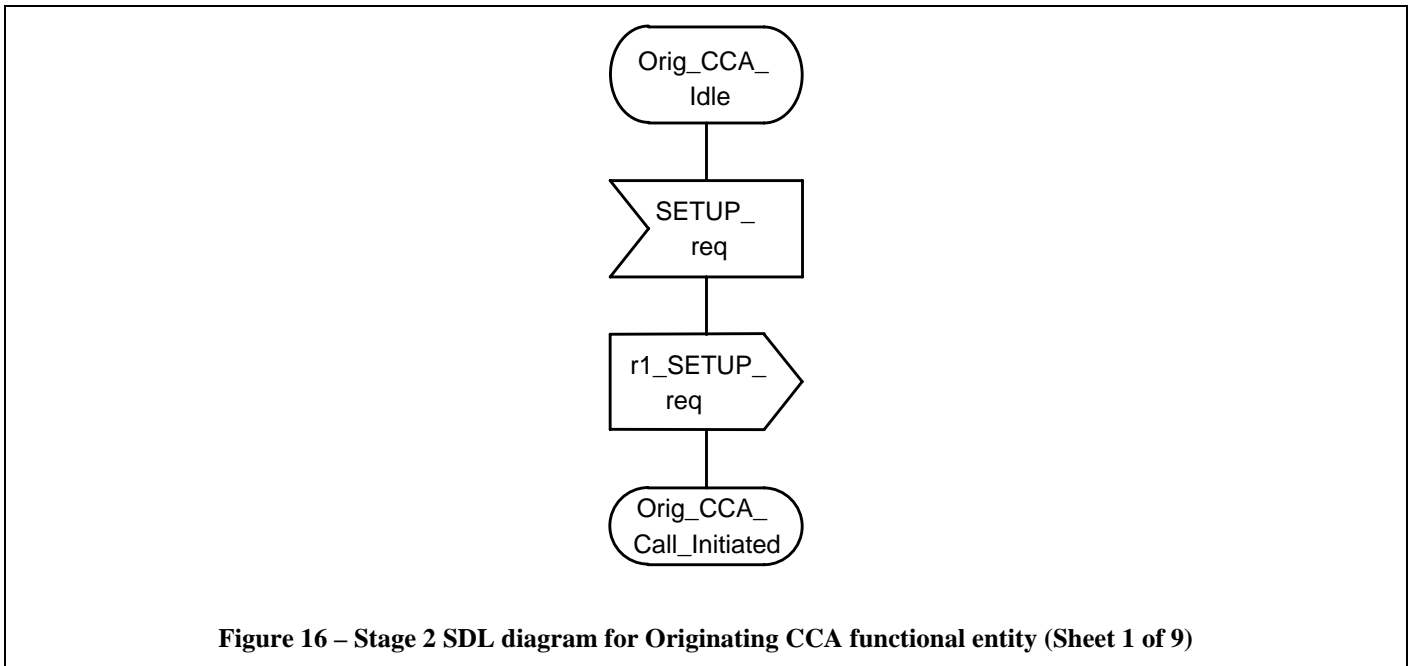

Figure 16 – Stage 2 SDL diagram for Originating CCA functional entity (Sheet 1 of 9)

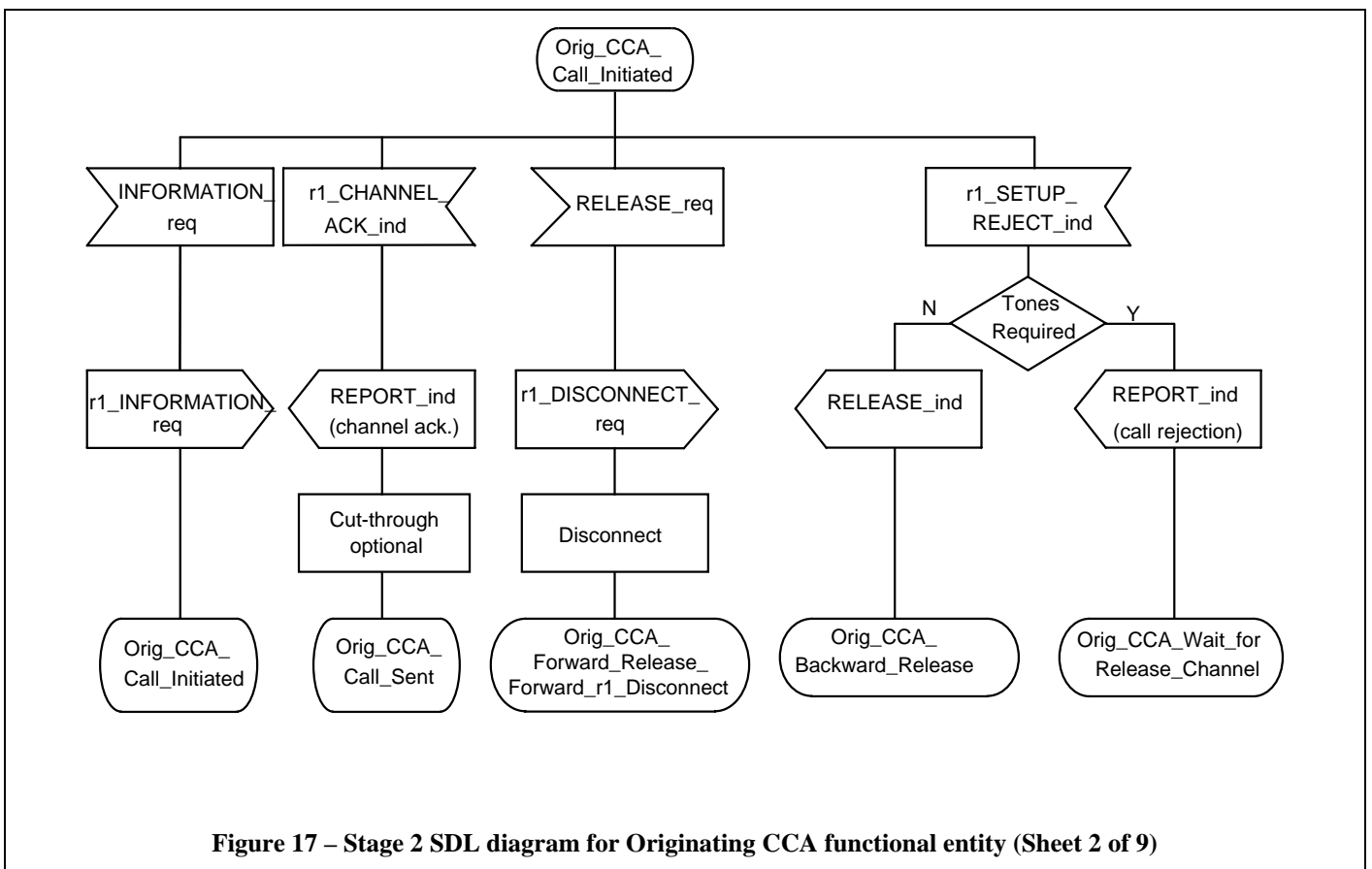

Figure 17 – Stage 2 SDL diagram for Originating CCA functional entity (Sheet 2 of 9)

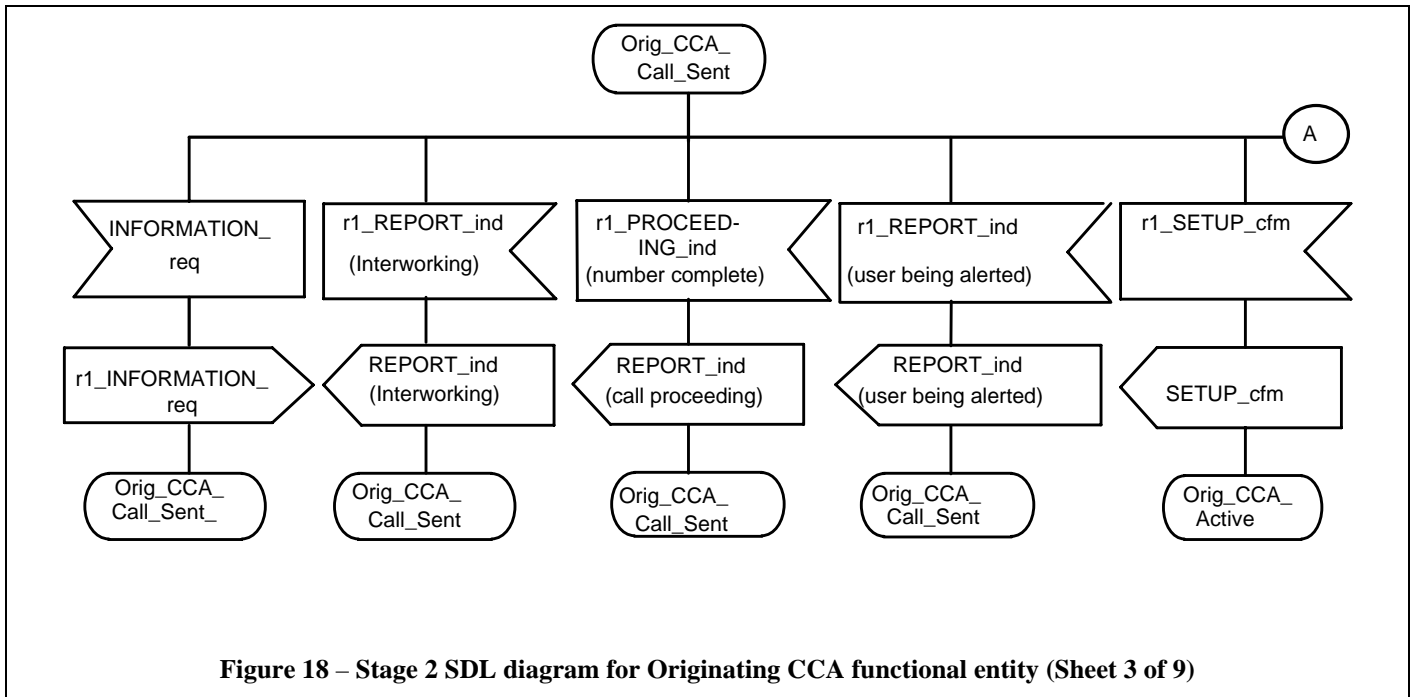

Figure 18 – Stage 2 SDL diagram for Originating CCA functional entity (Sheet 3 of 9)

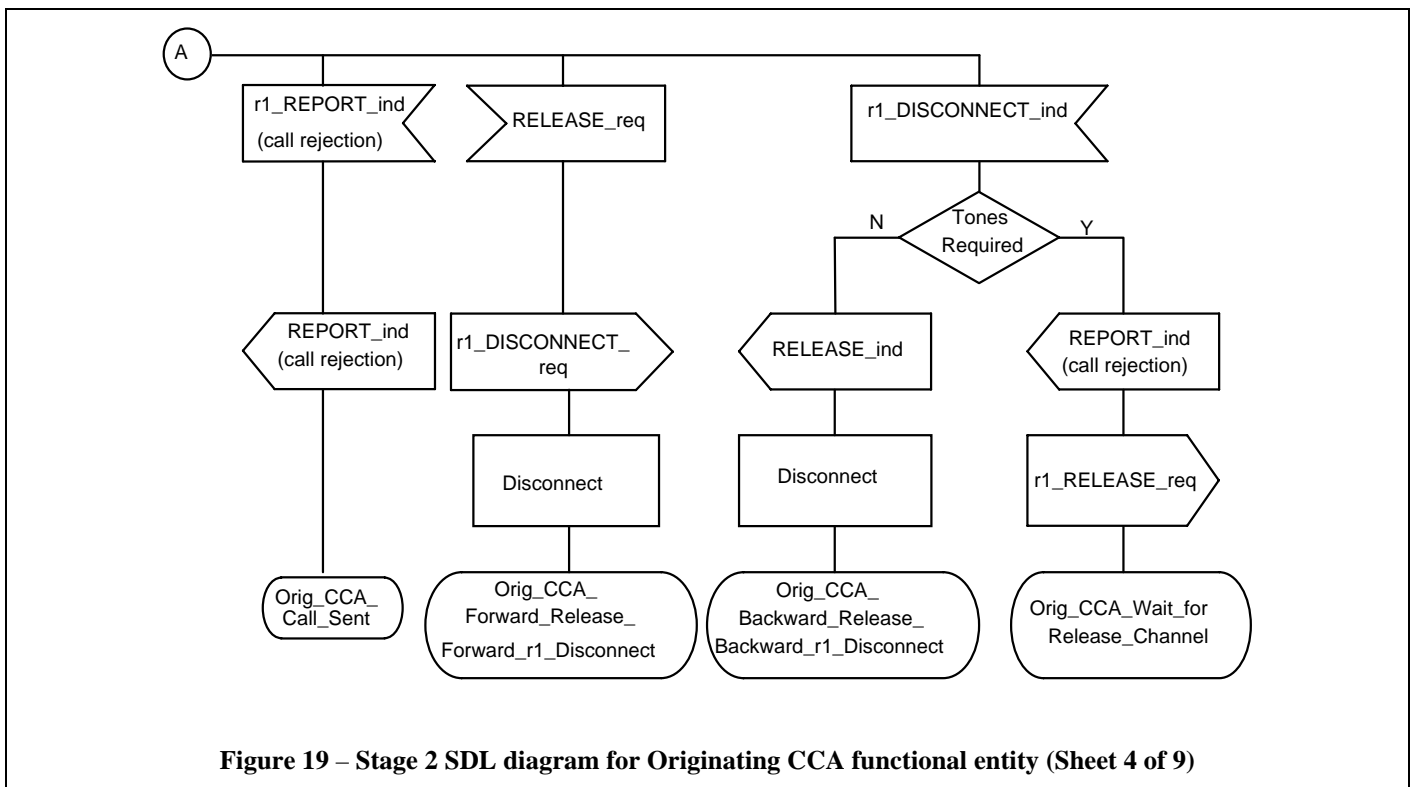

Figure 19 – Stage 2 SDL diagram for Originating CCA functional entity (Sheet 4 of 9)

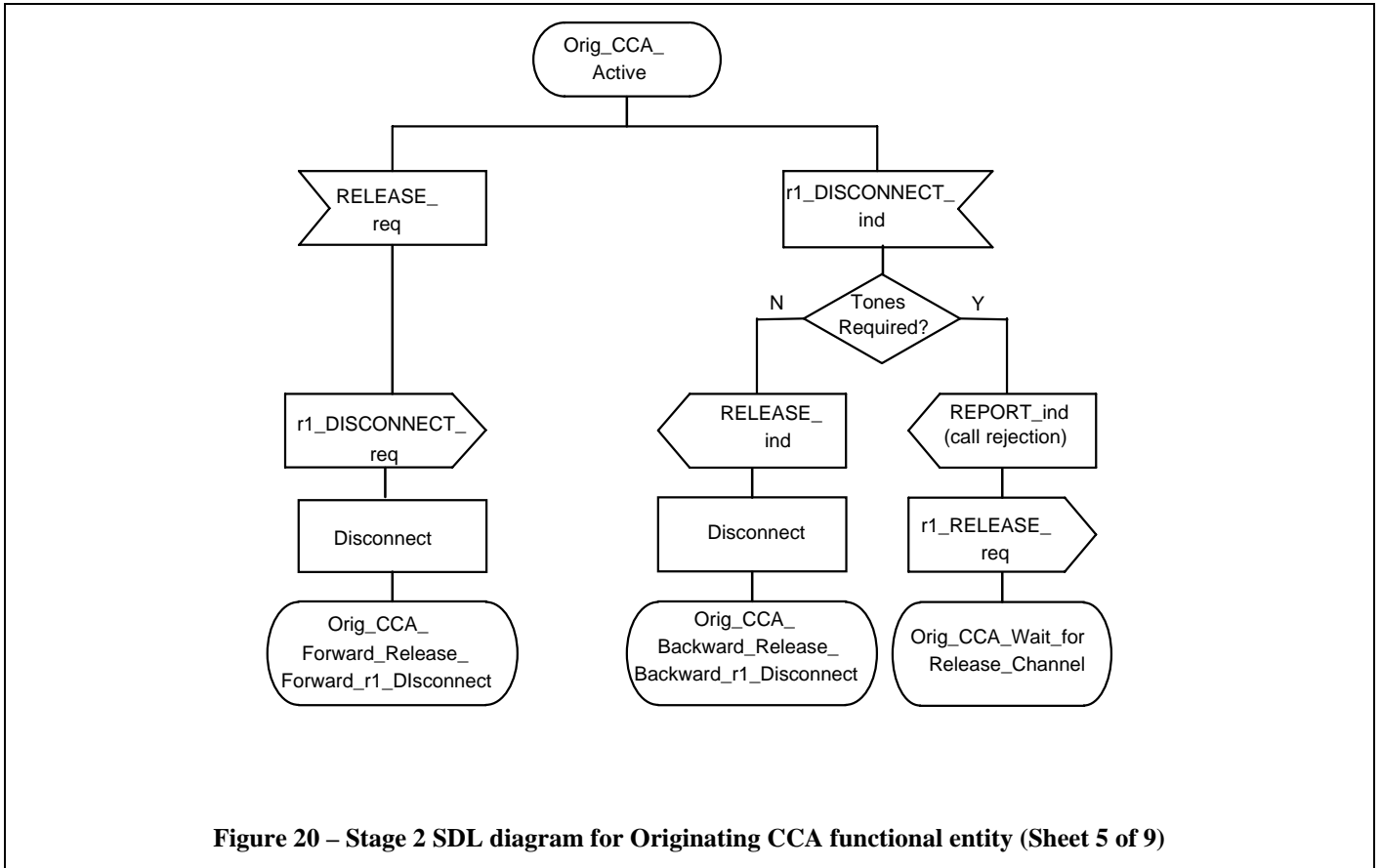

Figure 20 – Stage 2 SDL diagram for Originating CCA functional entity (Sheet 5 of 9)

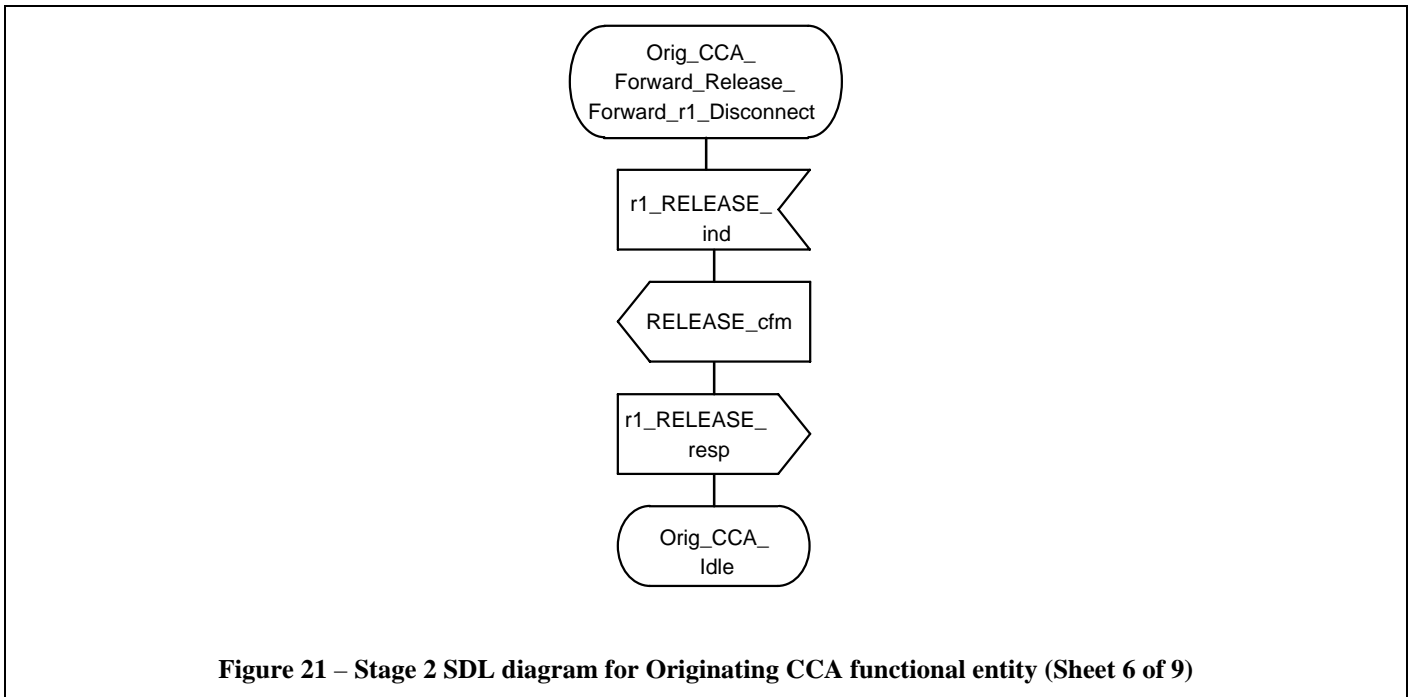

Figure 21 – Stage 2 SDL diagram for Originating CCA functional entity (Sheet 6 of 9)

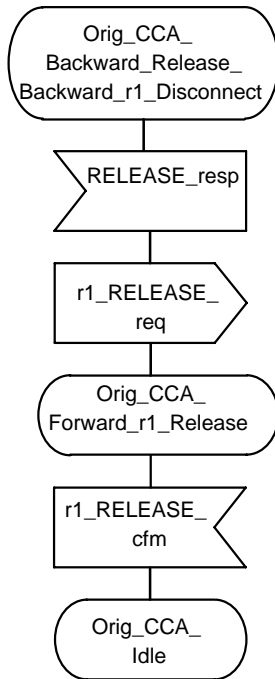

Figure 22 – Stage 2 SDL diagram for Originating CCA functional entity (Sheet 7 of 9)

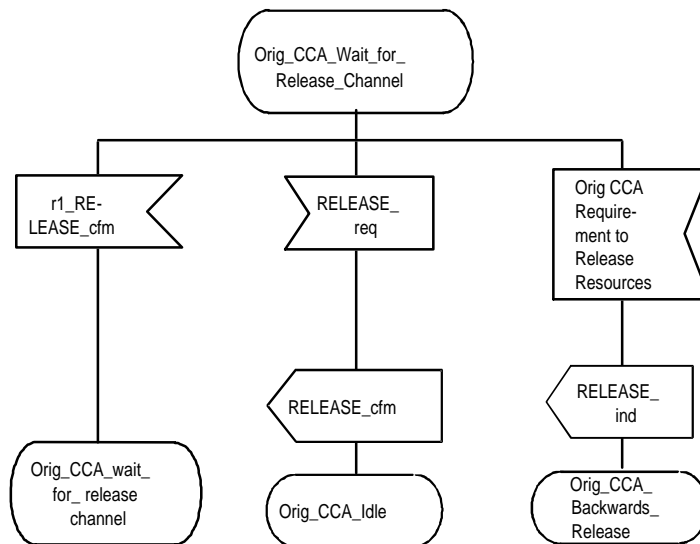

Figure 23 – Stage 2 SDL diagram for Originating CCA functional entity (Sheet 8 of 9)

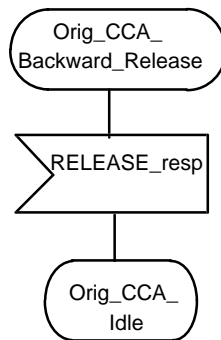

Figure 24 – Stage 2 SDL diagram for Originating CCA functional entity (Sheet 9 of 9)

15.2 Originating CC functional entity SDL diagrams

Output signals to the left and input signals from the left represent information flows across r1 to and from the Originating CCA functional entity. Output signals to the right and input signals from the right represent information flows across r2 to and from the Subsequent CC functional entity. The only exception to this rule is when the text within the signals explicitly identifies from what function the signal originates.

15.2.1 Originating CC states used in SDL diagrams

- **Orig_CC_Idle** - No Call in progress
- **Orig_CC_Call_Sent** - Call has been initiated by the CC, the channel has been reserved to the subsequent CC, and an end to end response is awaited.
- **Orig_CC_Wait_for_Release_Channel** - In-band tones/announcements being given to the PISN user, PISN user or CC originated clearing awaited.
- **Orig_CC_Call_Initiated** - Call has been initiated by the CC functional entity, and the CC is awaiting a response from the subsequent CC.
- **Orig_CC_Wait_for_Address_Info** - The CC is awaiting additional information from the Originating CCA.
- **Orig_CC_Call_Active** - Call is in active phase.
- **Orig_CC_Backward_r1_Release** - Resources have been disconnected, and clearing of the resources in the backward direction has been initiated, CC awaiting response from the Originating CCA.
- **Orig_CC_Backward_r1_Release_Forward_r2_Release** - Resources have been disconnected, and clearing has been initiated in both directions, awaiting responses from both the Originating CCA and the subsequent CC.
- **Orig_CC_Forward_r2_Release** - Resources have been disconnected, and clearing of the resources in the forward direction has been initiated, CC awaiting response from the subsequent CC.
- **Orig_CC_Backward_r1_Disconnect** - Disconnection of resources has been initiated, awaiting response from the Originating CCA.
- **Orig_CC_Backward_r1_Disconnect_forward_r2_Release** - Resources have been disconnected and clearing of resources in the forward direction has been initiated. The CC is awaiting response from the originating CCA.

15.2.2 Originating CC SDL diagrams

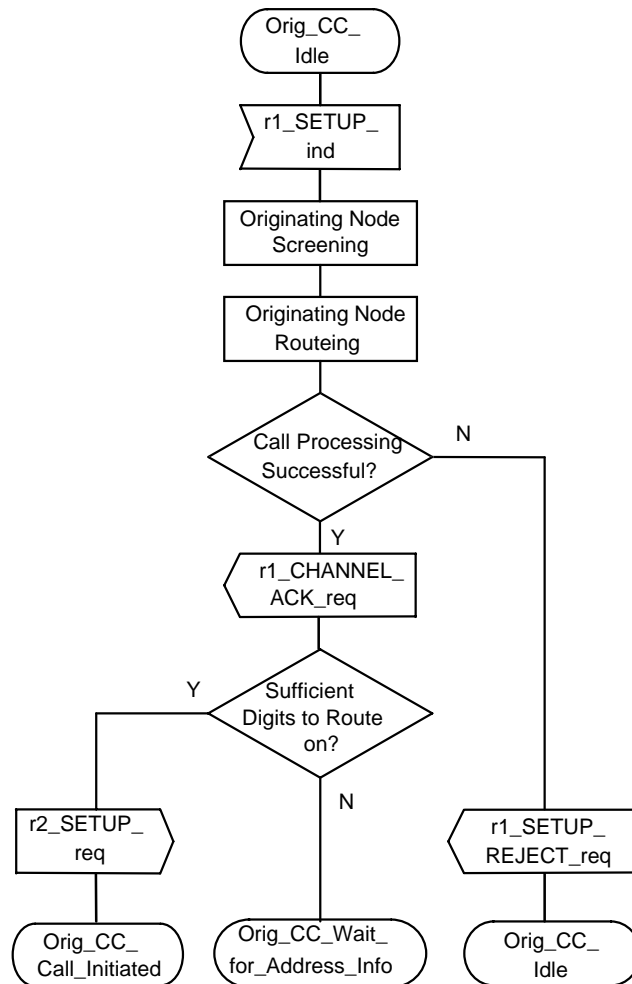

Figure 25 – Stage 2 SDL diagram for Originating CC functional entity (Sheet 1 of 12)

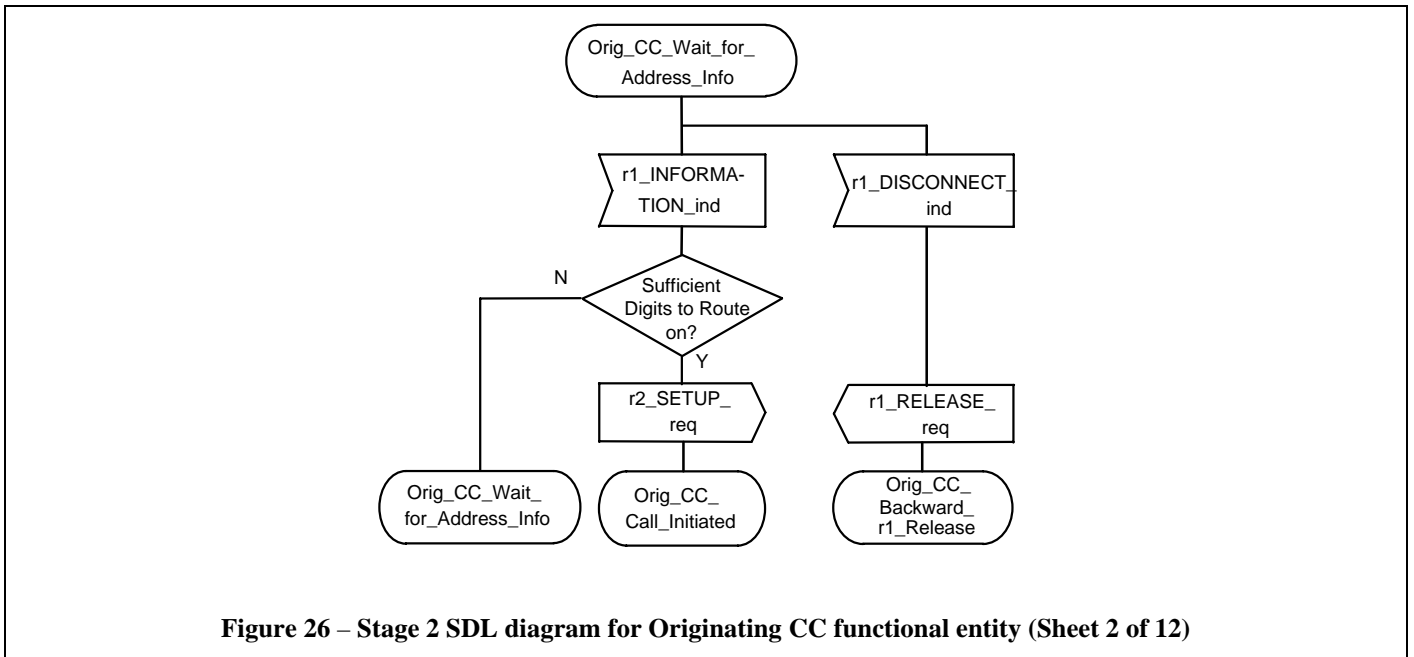
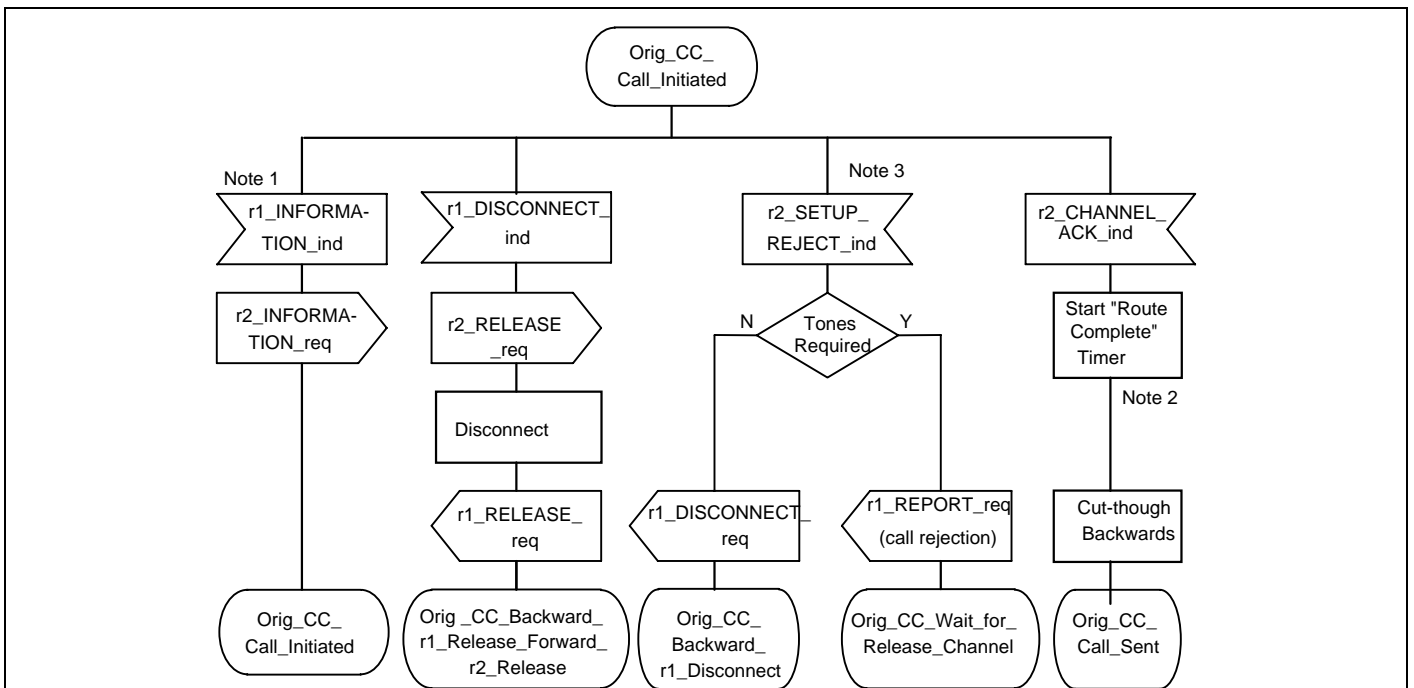

Figure 26 – Stage 2 SDL diagram for Originating CC functional entity (Sheet 2 of 12)



NOTES –

1. This information flow is not acted upon after the receipt of a SETUP or INFORMATION information flow with an 'number complete indicator' parameter. There is an interdigit timer that is active, on the expiry of this timer no more INFORMATION information flows are accepted.
2. This is the earliest that the CC functional entity can cut through in the forward direction.
3. This Standard does not exclude possible implementation specific procedures which do not result in the call being released, eg., alternate routing.

Figure 27 – Stage 2 SDL diagram for Originating CC functional entity (Sheet 3 of 12)

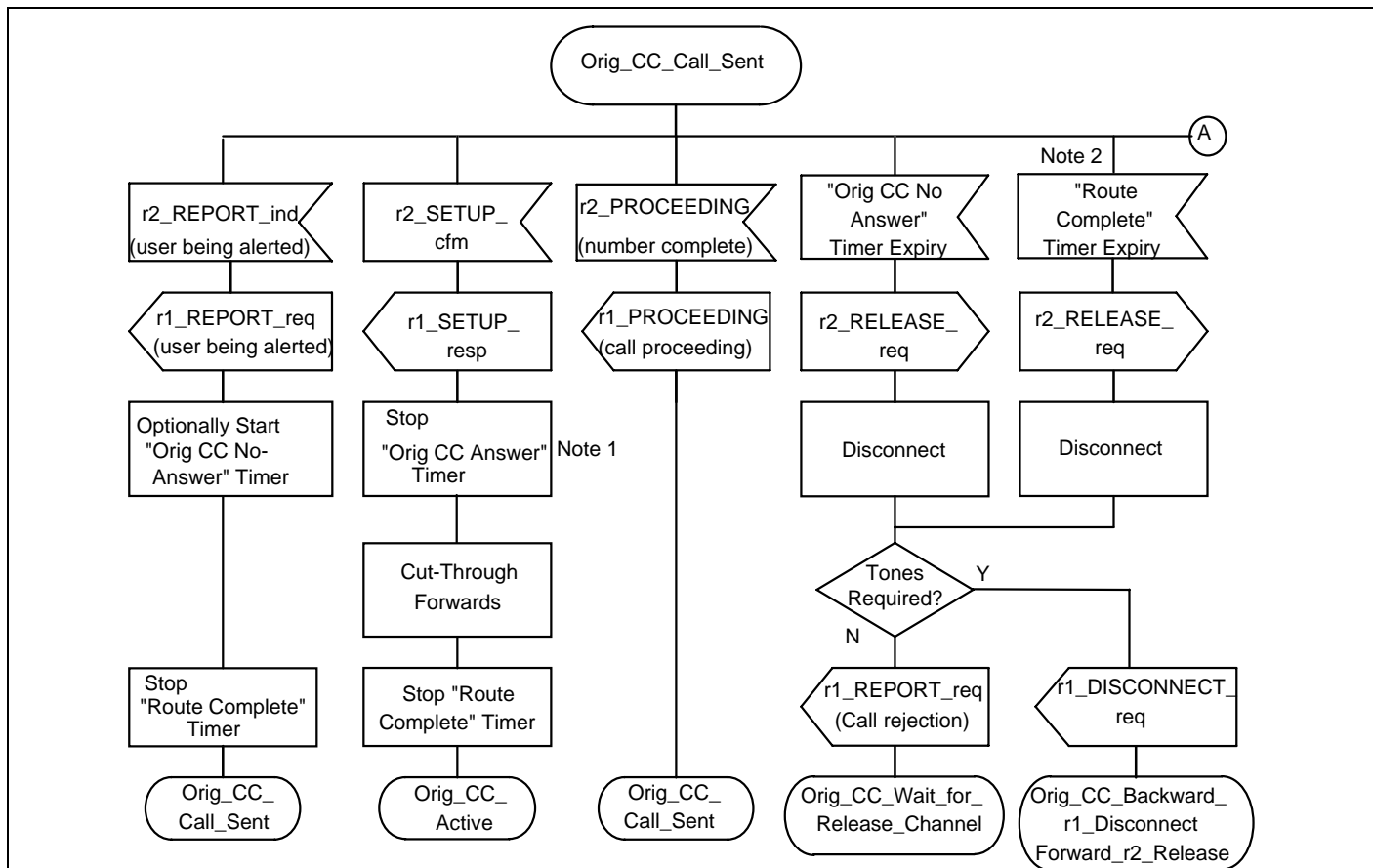

NOTES –

1. This is the earliest that the CC functional entity can cut through in the backward direction.
2. This Standard does not exclude possible implementation specific procedures which do not result in the call being released, eg., alternate routing.

Figure 28 – Stage 2 SDL diagram for Originating CC functional entity (Sheet 4 of 12)

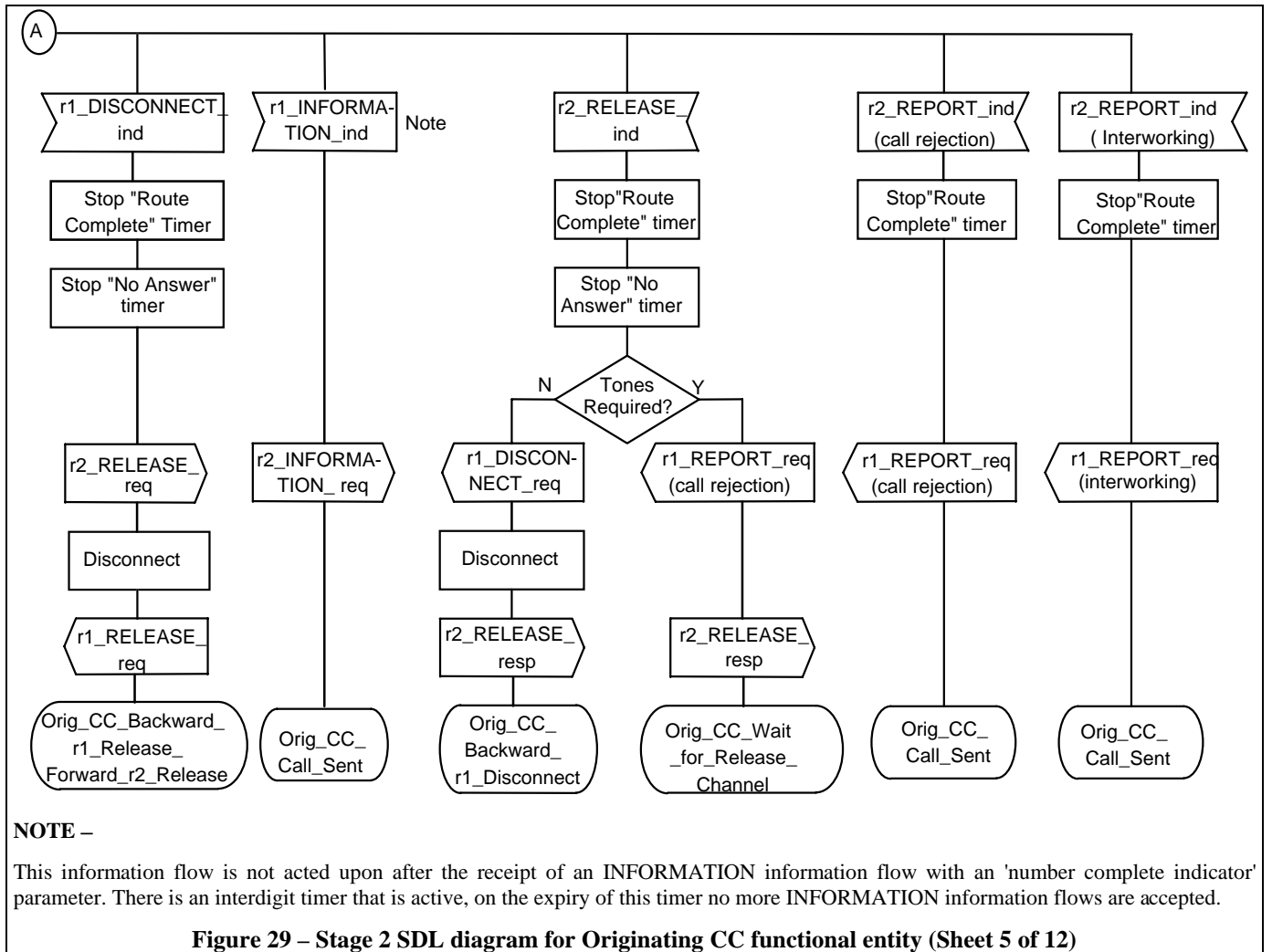

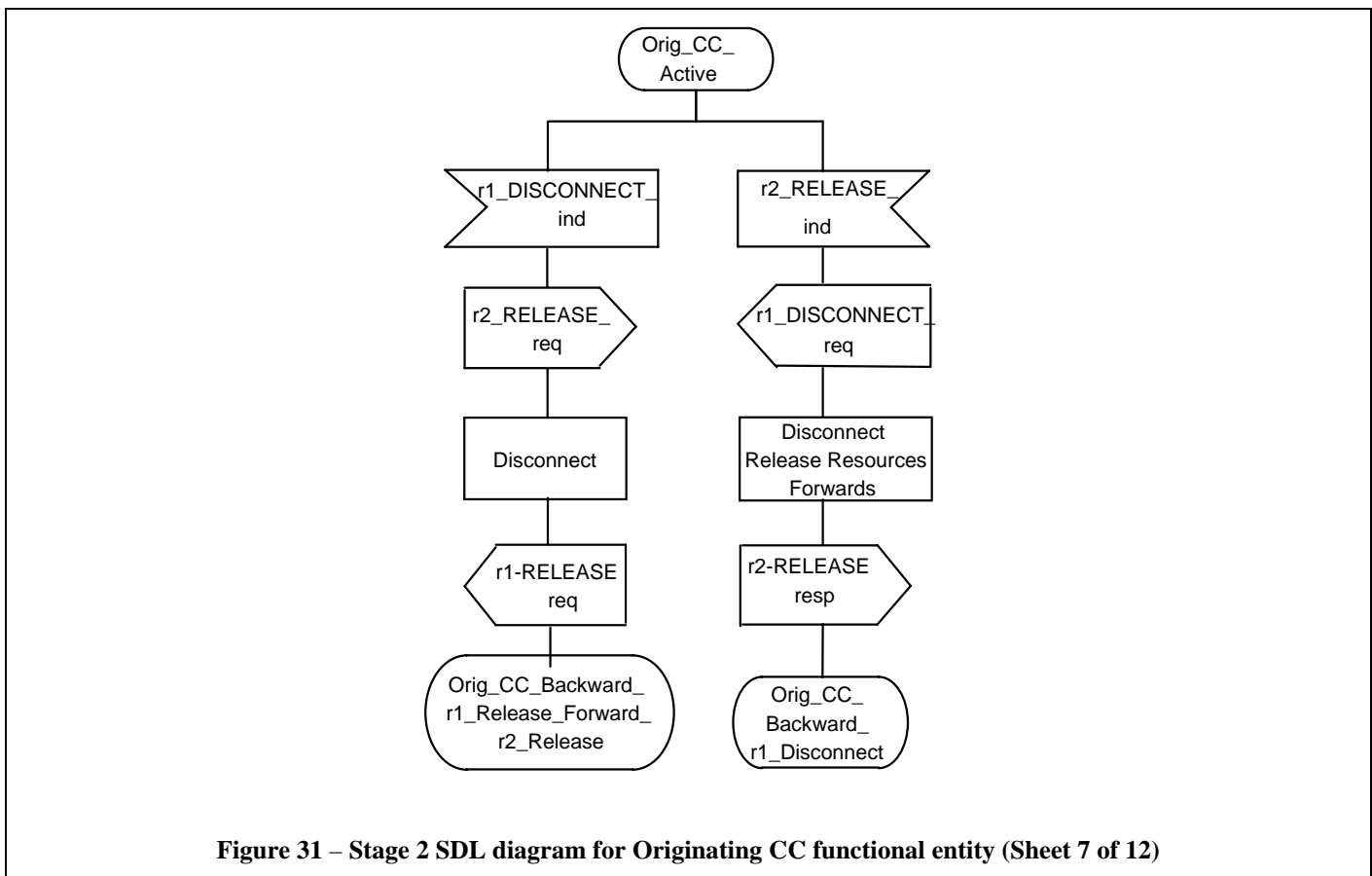
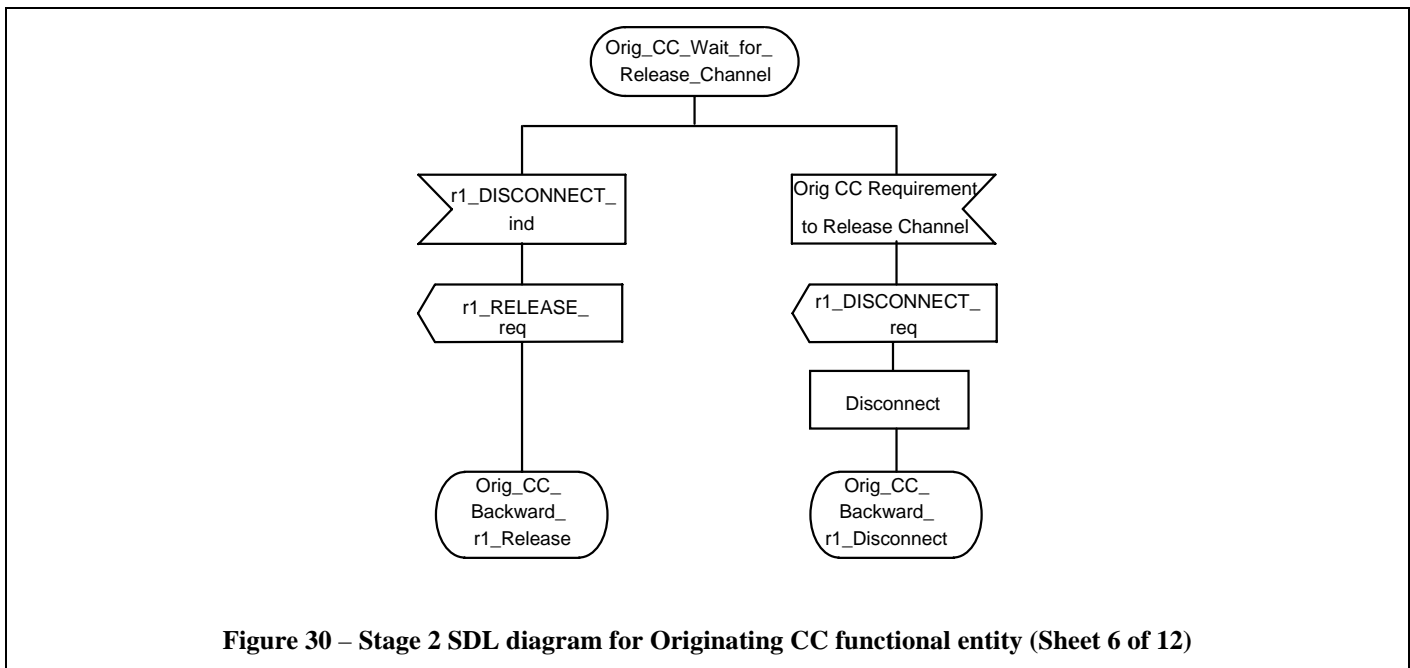

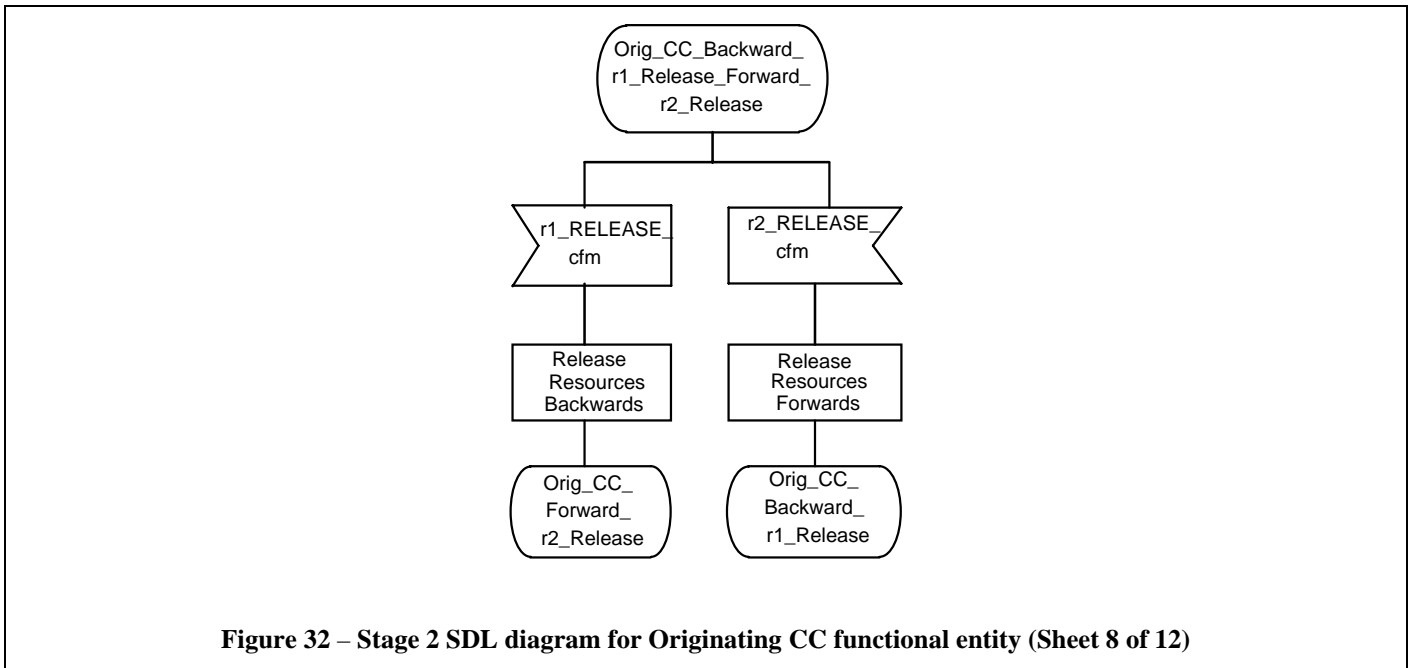

Figure 32 – Stage 2 SDL diagram for Originating CC functional entity (Sheet 8 of 12)

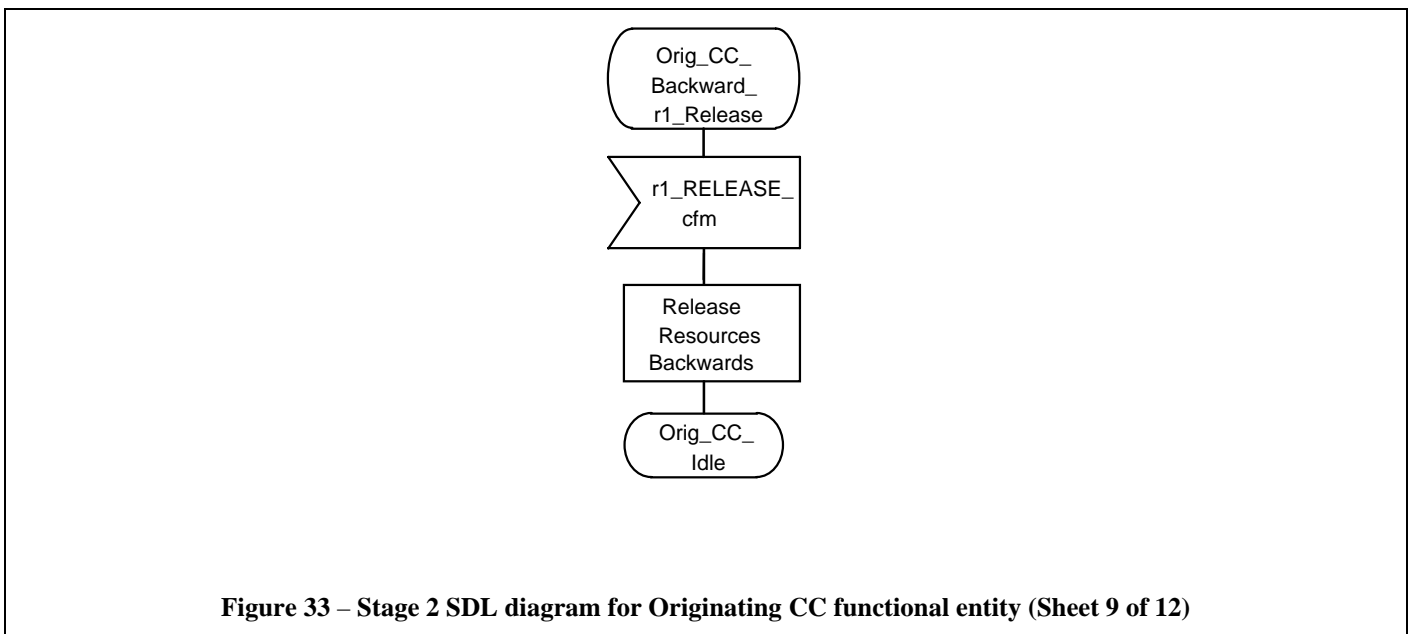

Figure 33 – Stage 2 SDL diagram for Originating CC functional entity (Sheet 9 of 12)

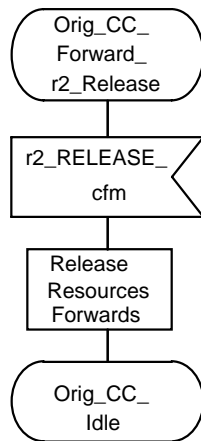

Figure 34 – Stage 2 SDL diagram for Originating CC functional entity (Sheet 10 of 12)

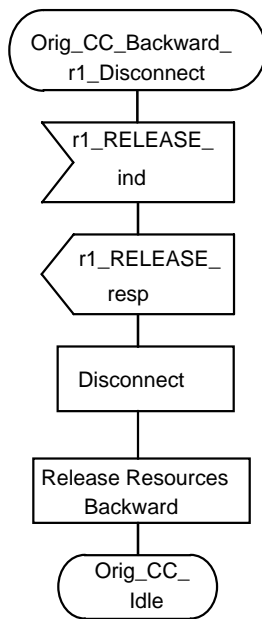
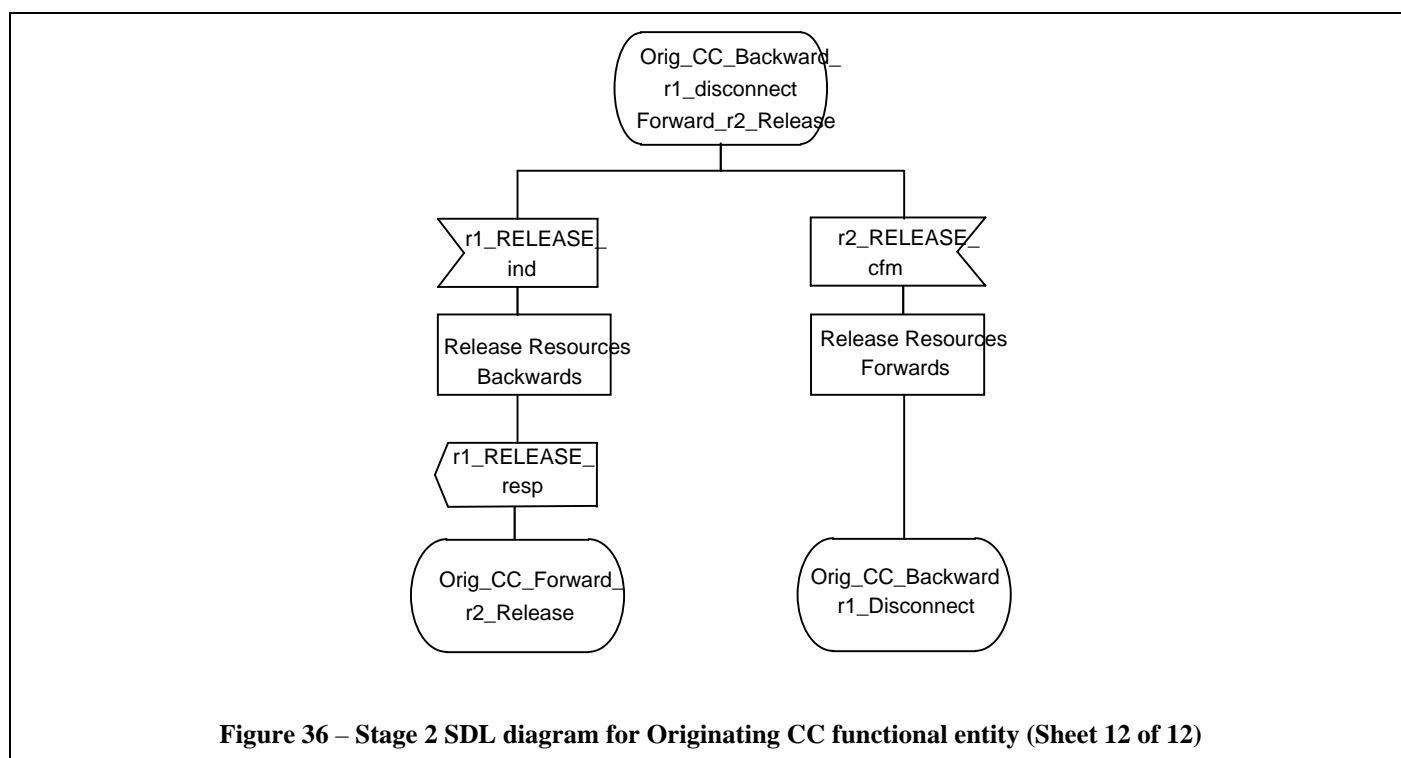

Figure 35 – Stage 2 SDL diagram for Originating CC functional entity (Sheet 11 of 12)



15.3 Transit CC functional entity SDL diagrams

Output signals to the left and input signals from the left represent information flows across r2 to and from the preceding CC functional entity. Output signals to the right and input signals from the right represent information flows across r2 to and from the Subsequent CC functional entity. The only exception to this rule is when the text within the signals explicitly identifies from what function the signal originates.

15.3.1 Transit CC states used in SDL diagrams

- **Transit_CC_Idle** - No Call in progress
- **Transit_CC_Call_Sent** - Call has been initiated by the CC, the channel has been reserved to the subsequent CC, and an end to end response is awaited.
- **Transit_CC_Wait_for_Release_Channel** - In-band tones/announcements being given to the PISN user, PISN user or CC originated clearing awaited.
- **Transit_CC_Call_Initiated** - Call has been initiated by the CC functional entity, and the CC is awaiting a response from the subsequent CC.
- **Transit_CC_Wait_for_Address_Info** - The CC is awaiting additional information from the preceding CC.
- **Transit_CC_Call_Active** - Call is in active phase.
- **Transit_CC_Backward_r2_Release** - Resources have been disconnected, and clearing of the resources in the backward direction has been initiated, CC awaiting response from the preceding CC.
- **Transit_CC_Forward_r2_Release** - Resources have been disconnected, and clearing of the resources in the forward direction has been initiated, CC awaiting response from the subsequent CC.

15.3.2 Transit CC SDL diagrams

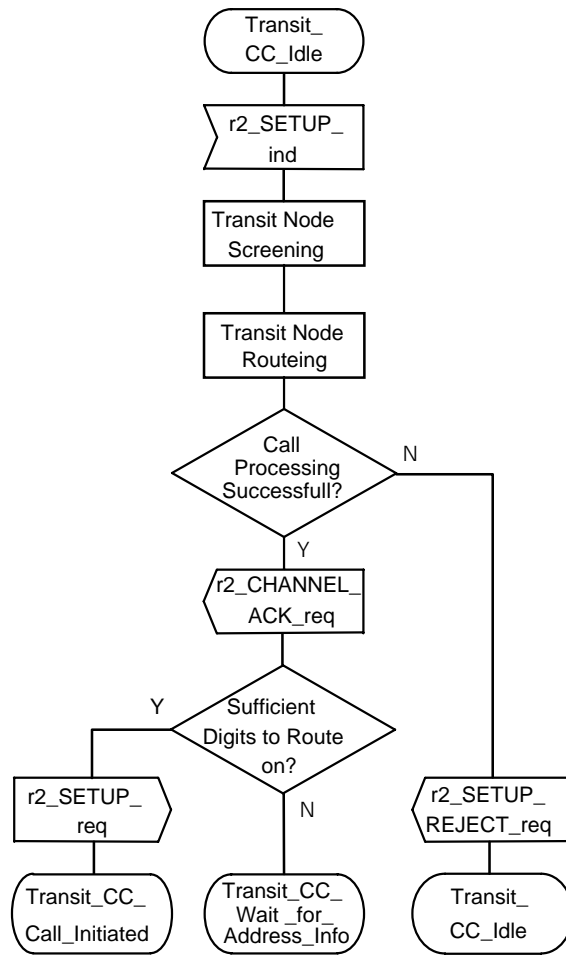

Figure 37 – Stage 2 SDL diagram for Transit CC functional entity (Sheet 1 of 8)

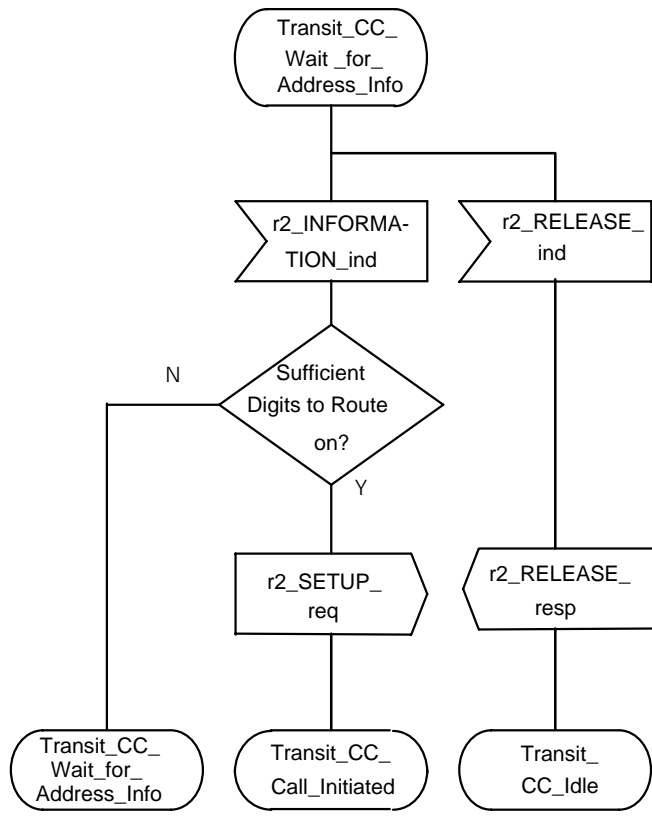
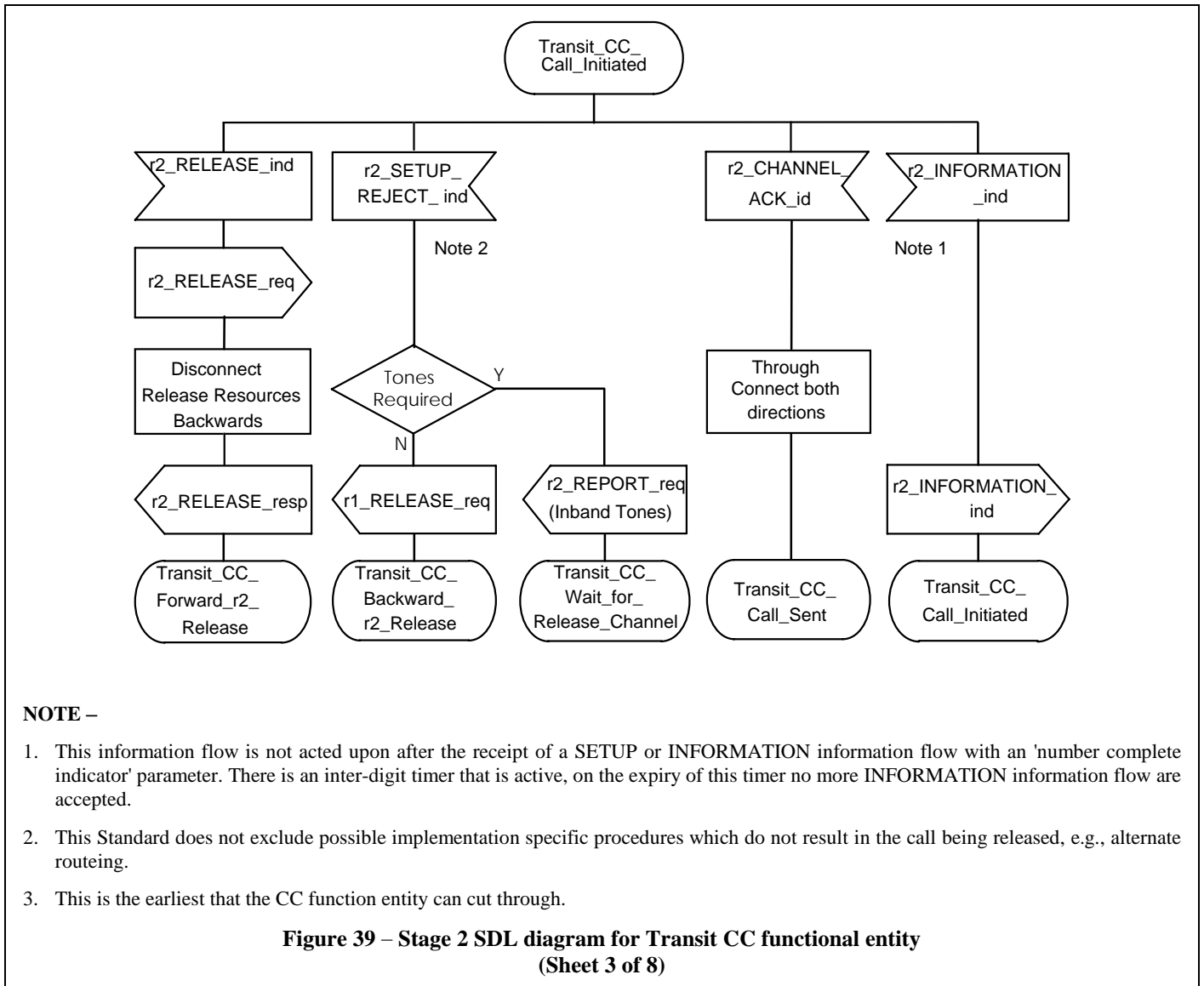
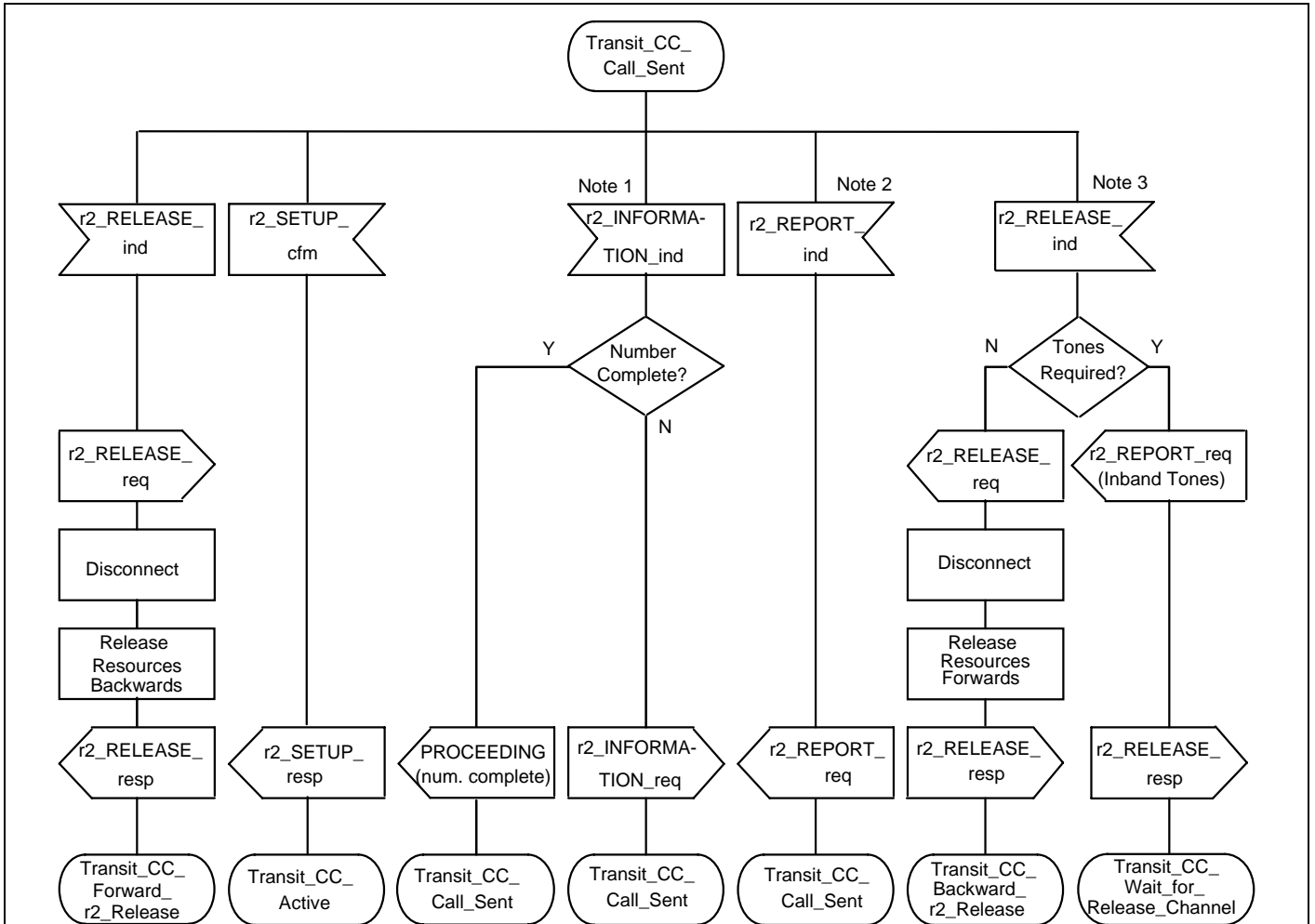

Figure 38 – Stage 2 SDL diagram for Transit CC functional entity (Sheet 2 of 8)





NOTES –

1. This information flow is not acted upon after the receipt of an INFORMATION information flow with an 'number complete indicator' parameter. There is an inter-digit timer that is active, on the expiry of this timer no more INFORMATION information flows are accepted.
2. The REPORT information flow can have the parameters: 'interworking', or 'call rejection'
3. This Standard does not exclude possible implementation specific procedures which do not result in the call being released, e.g., alternate routing.

**Figure 40 – Stage 2 SDL diagram for Transit CC functional entity
(Sheet 4 of 8)**

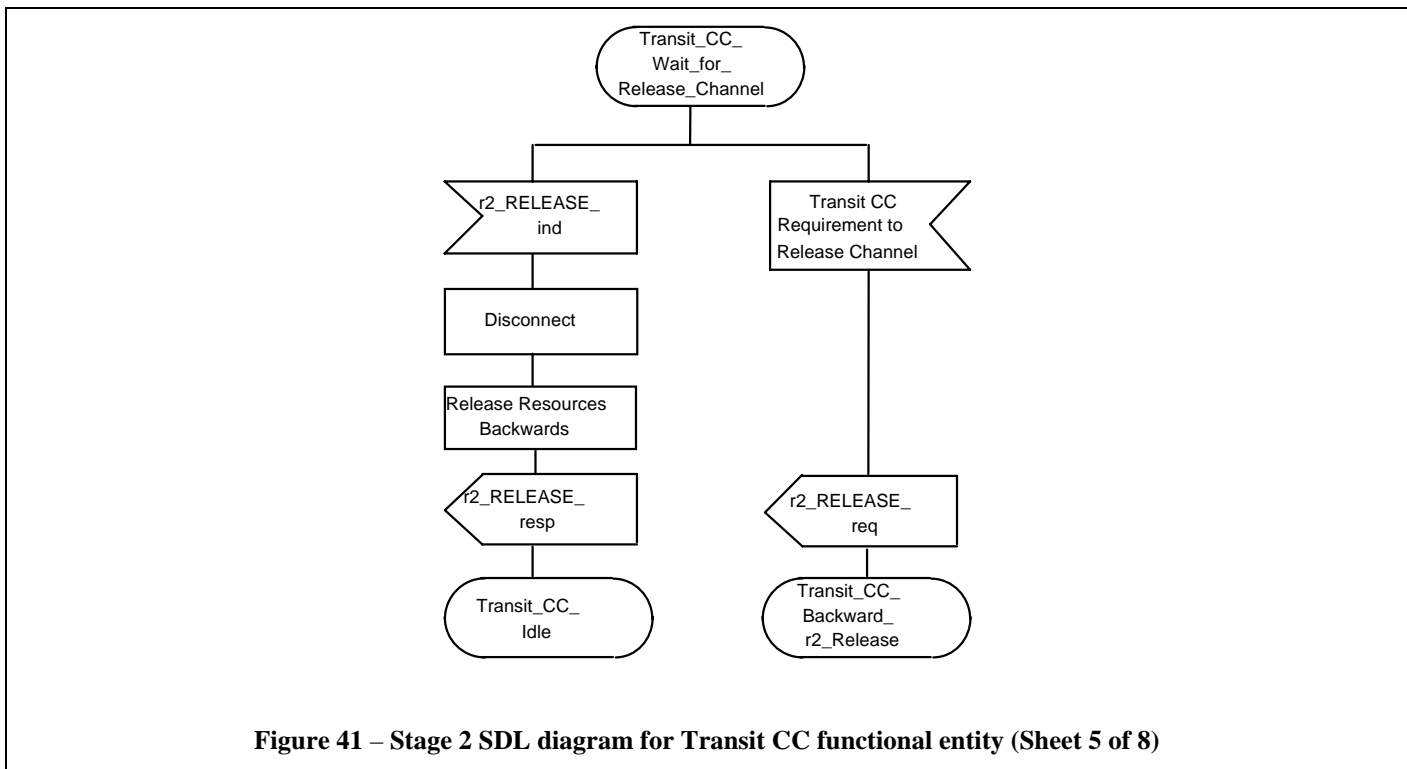

Figure 41 – Stage 2 SDL diagram for Transit CC functional entity (Sheet 5 of 8)

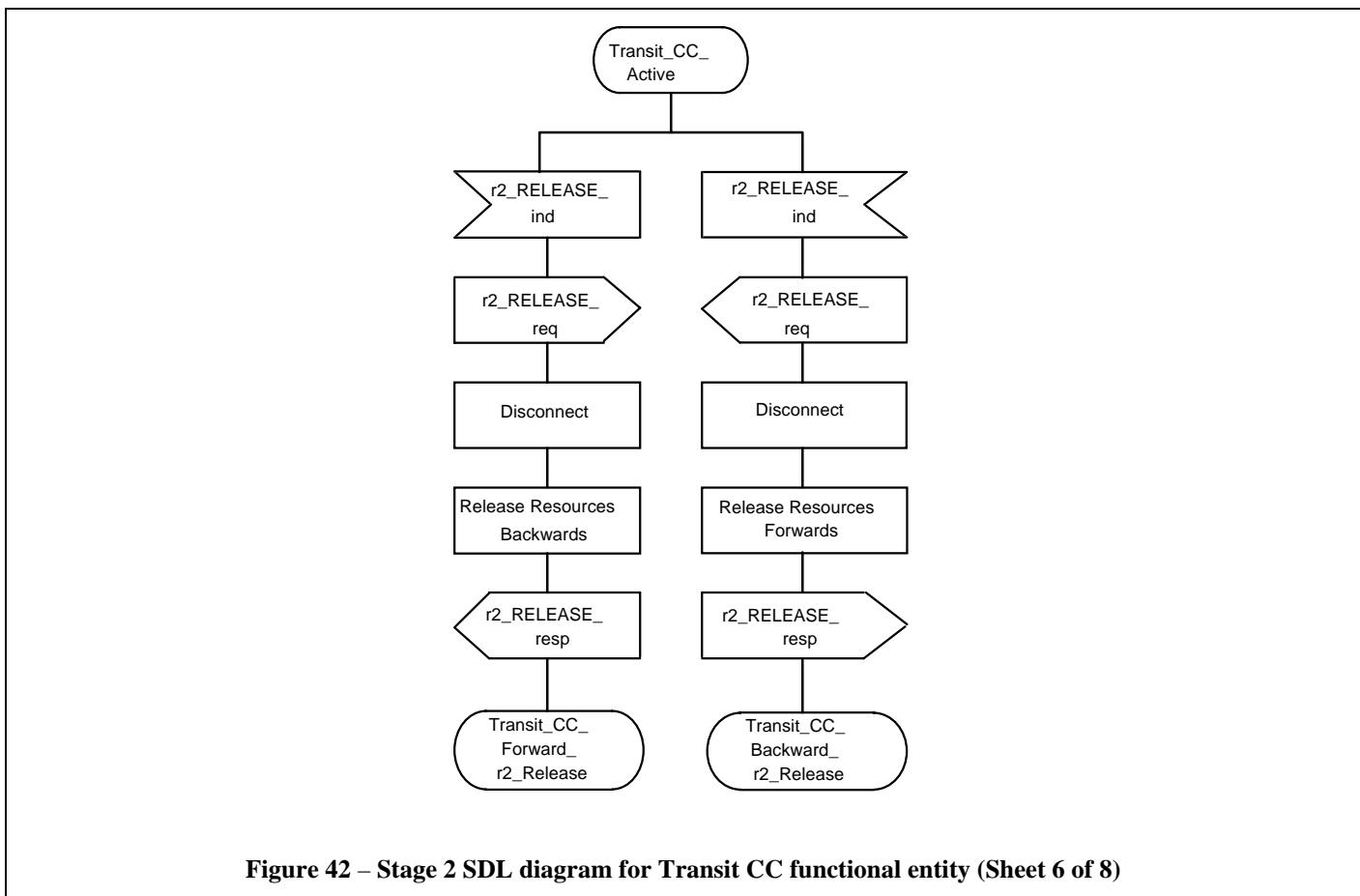

Figure 42 – Stage 2 SDL diagram for Transit CC functional entity (Sheet 6 of 8)

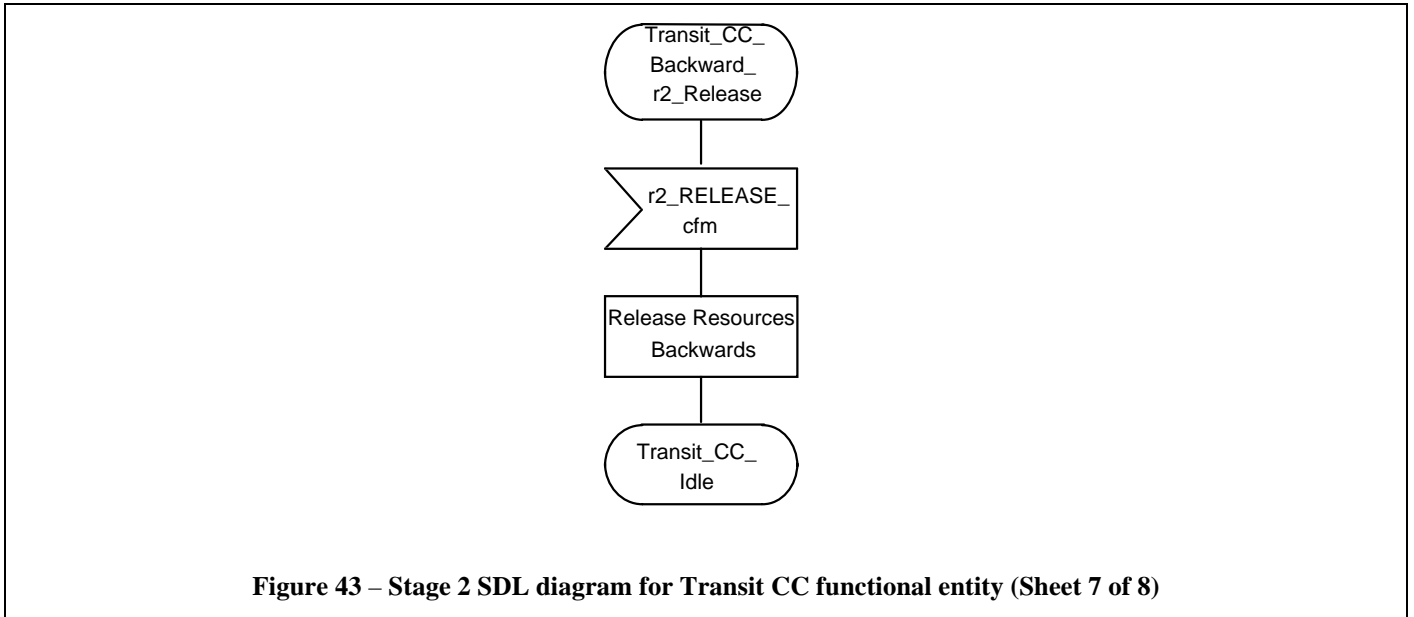

Figure 43 – Stage 2 SDL diagram for Transit CC functional entity (Sheet 7 of 8)

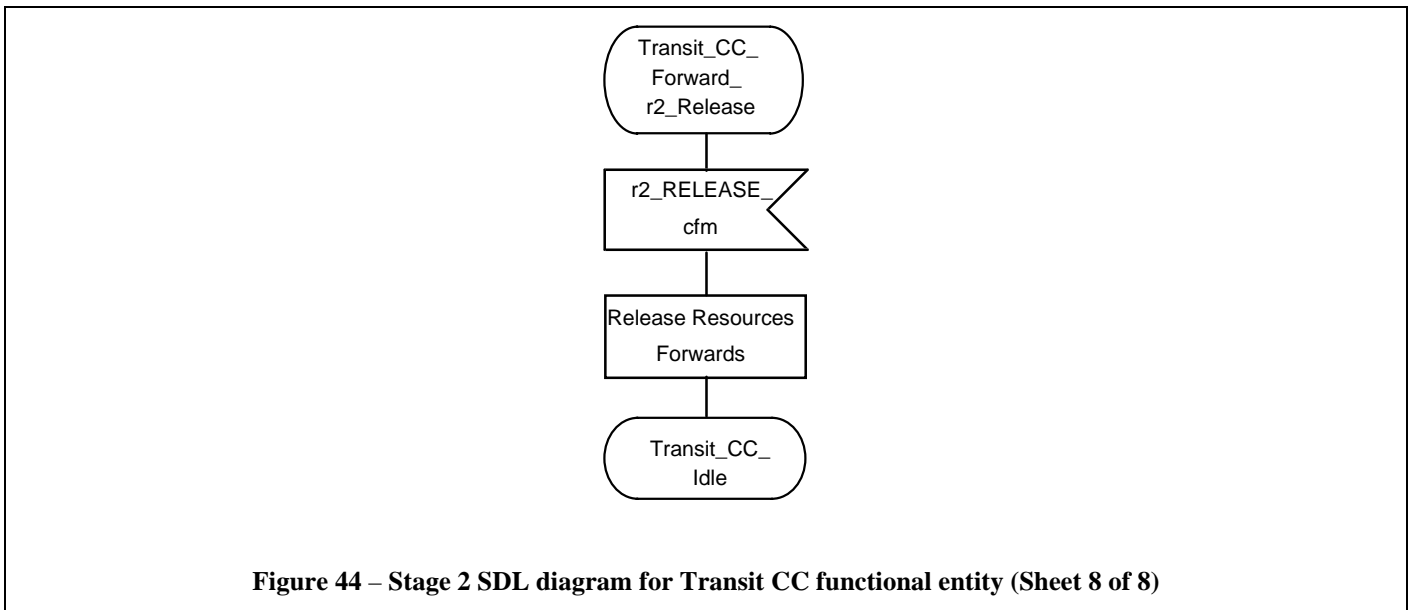

Figure 44 – Stage 2 SDL diagram for Transit CC functional entity (Sheet 8 of 8)

15.4 Destination CC functional entity SDL diagrams

Output signals to the left and input signals from the left represent information flows across r2 to and from the preceding CC functional entity. Output signals to the right and input signals from the right represent information flows across r3 to and from the Destination CCA functional entity. The only exception to this rule is when the text within the signals explicitly identifies from what function the signal originates.

15.4.1 Destination CC states used in SDL diagrams

- **Dest_CC_Idle** - No Call in progress
- **Dest_CC_Await_Response** - Call has been initiated by the CC, and the CC awaits responses from the CCAs.
- **Dest_CC_Wait_for_Release_Channel** - In-band tones /announcements being given to the calling PISN user, PISN user or CC originated clearing awaited.
- **Dest_CC_Wait_for_Address_Info** - The CC is awaiting additional information from the preceding CC.

- **Dest_CC_Call_Active** - Call is in active phase.
- **Dest_CC_Backward_r2_Release** - Resources have been disconnected, and clearing of the resources in the backward direction has been initiated, CC awaiting response from the preceding CC.
- **Dest_CC_Forward_r3_Release_Backward_r2_Release** - Resources have been disconnected, and clearing has been initiated in both directions, CC awaiting responses from both the Destination CCA and the preceding CC.
- **Dest_CC_Forward_r3_Release** - Resources have been disconnected, and clearing of the resources in the forward direction has been initiated, CC awaiting response from the Destination CCA.
- **Dest_CC_Forward_r3_Disconnect** - Disconnection has been initiated, CC awaiting Destination CCA response.

15.4.2 Destination CC SDL diagrams

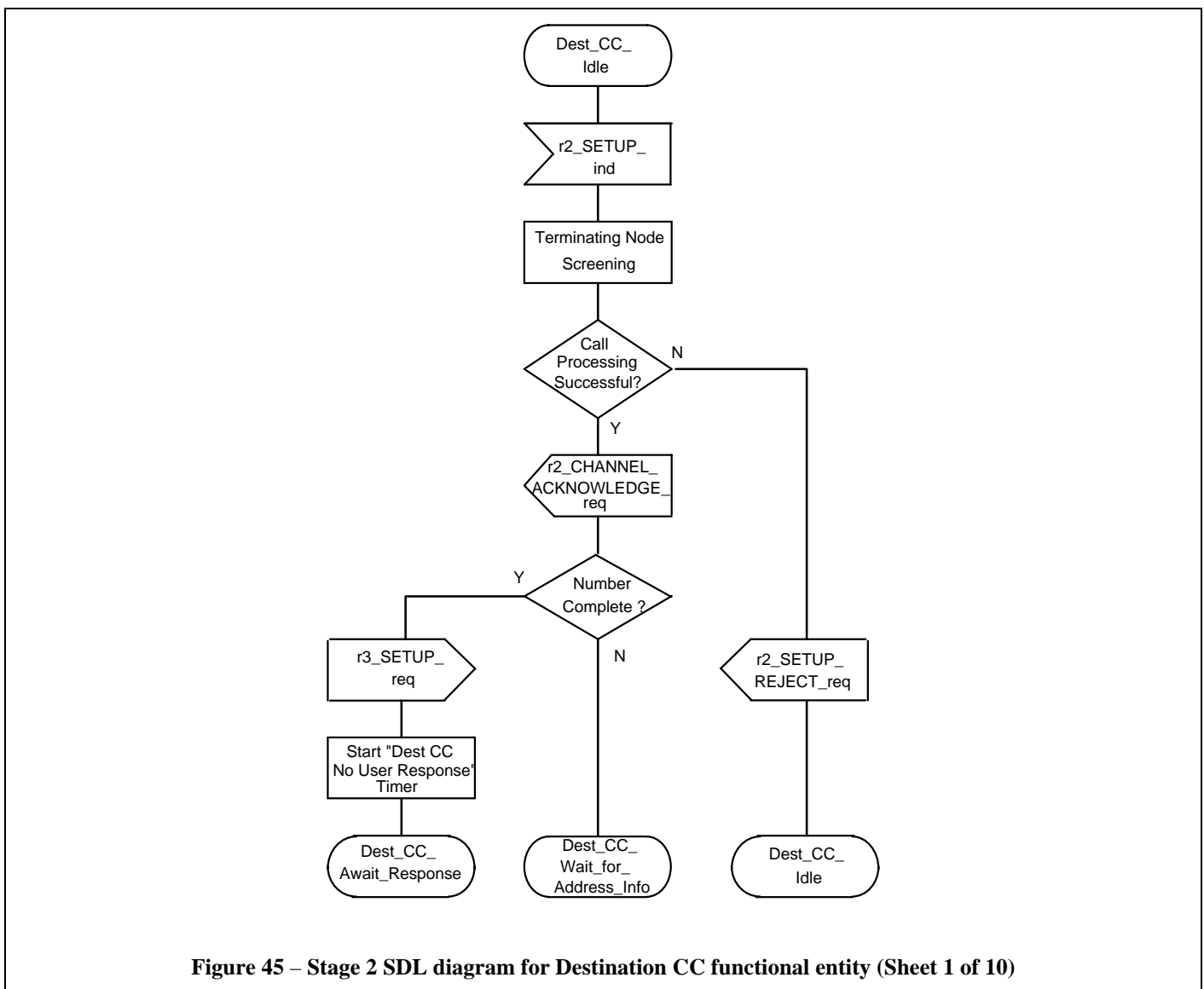

Figure 45 – Stage 2 SDL diagram for Destination CC functional entity (Sheet 1 of 10)

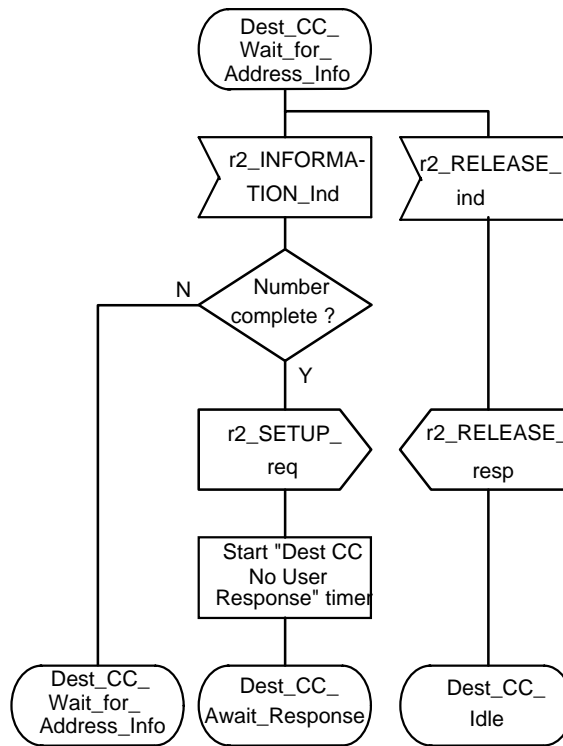
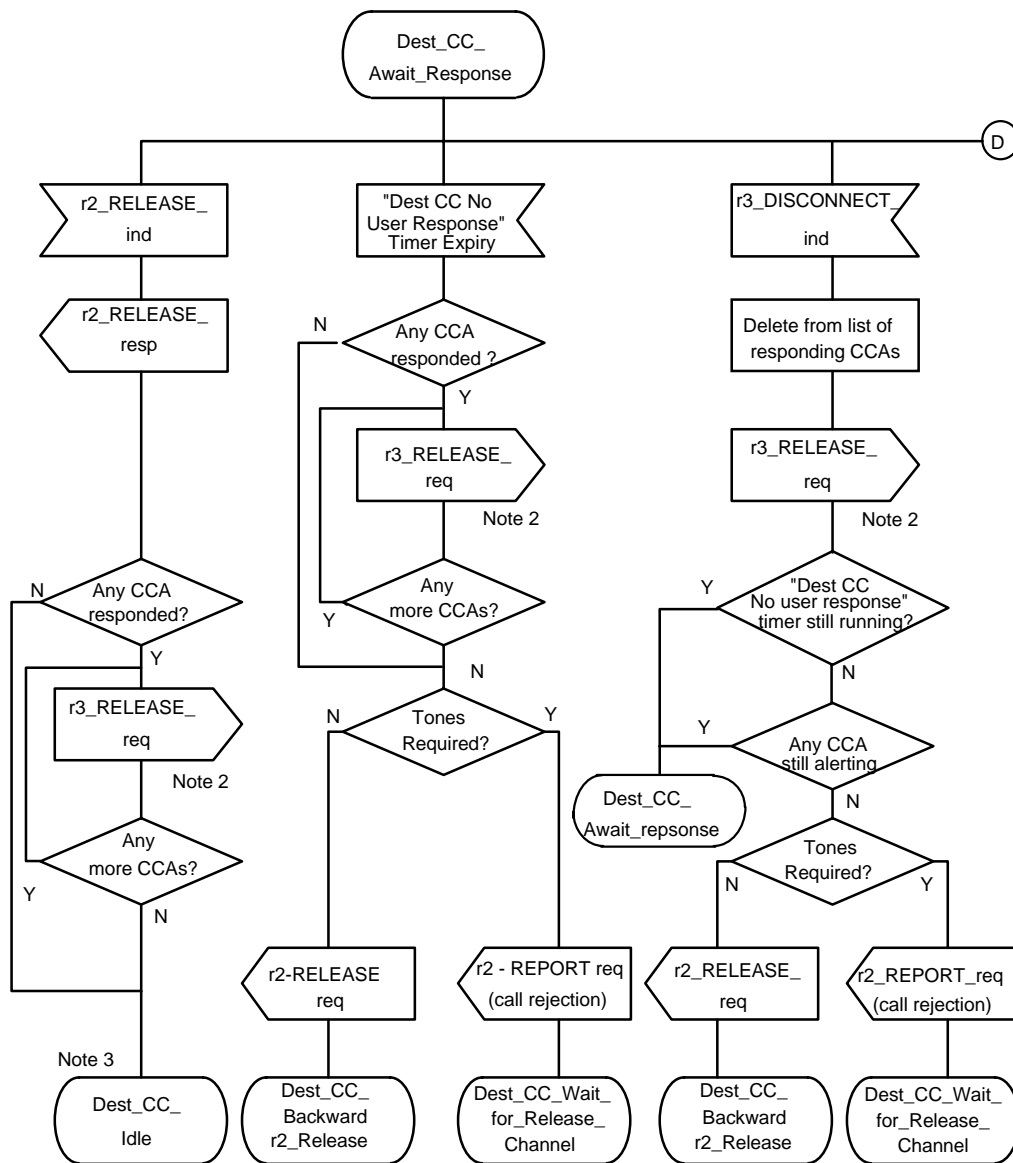

Figure 46 – Stage 2 SDL diagram for Destination CC functional entity (Sheet 2 of 10)



NOTES –

1. The provision of Ring Tone depends on the Basic Service provided.
2. A separate state machine is generated (not shown) for each CCA to which an r3_RELEASE_req is sent. The separate state machine is cleared on receipt of an r3_RELEASE_cfm.
3. If any further CCAs respond prior to the expiry of the "Destination CC No User response" timer, they should be cleared by sending a r3_RELEASE_req and generating a new state machine to await confirmation.

**Figure 47 – Stage 2 SDL diagram for Destination CC functional entity
(Sheet 3 of 10)**

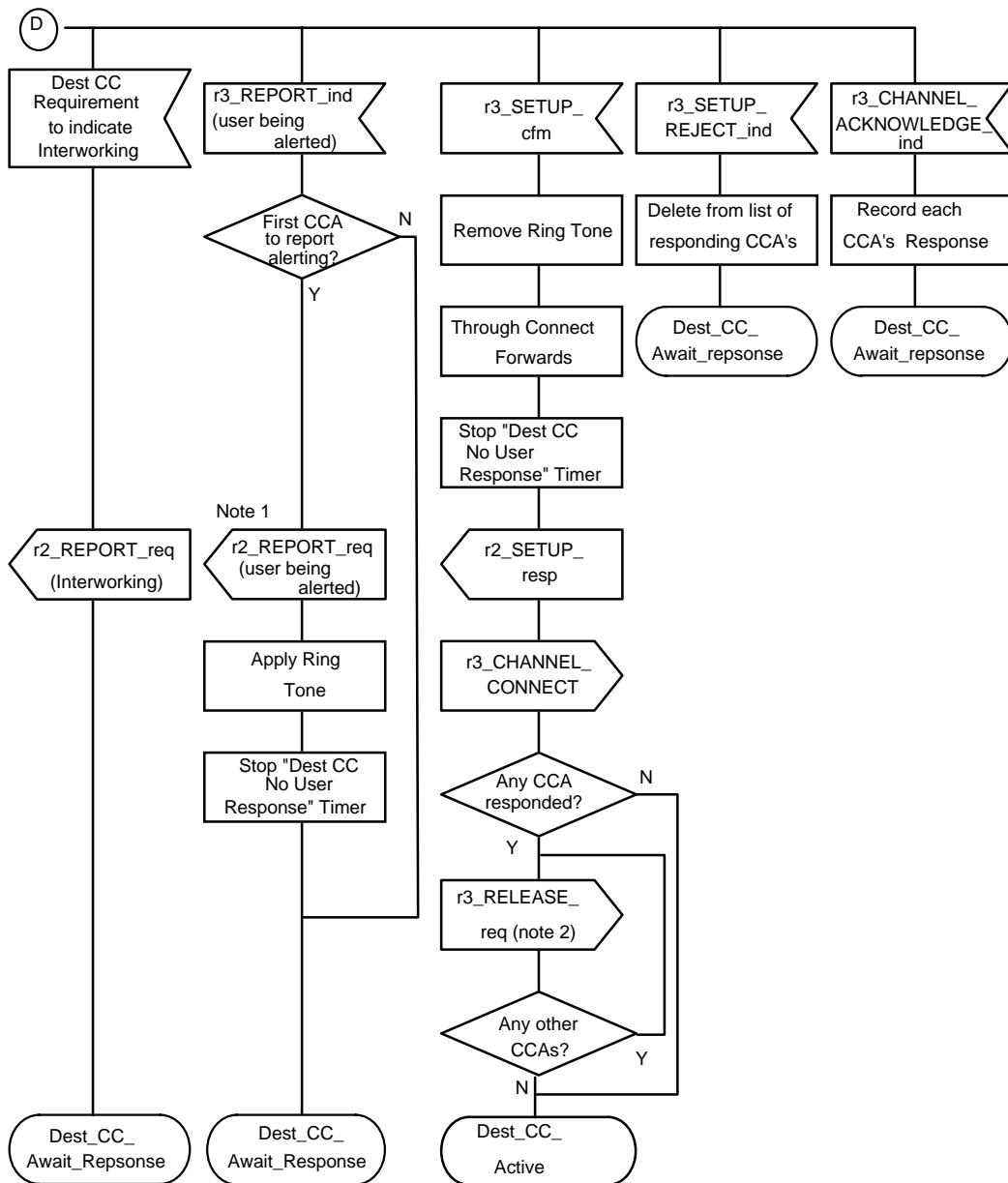

NOTES –

1. The provision of Ring Tone depends on the Basic Service provided.
2. A separate state machine is generated (not shown) for each CCA to which an r3_RELEASE_req is sent. The separate state machine is cleared on receipt of an r3_RELEASE_cfm.

**Figure 48 – Stage 2 SDL diagram for Destination CC functional entity
(Sheet 4 of 10)**

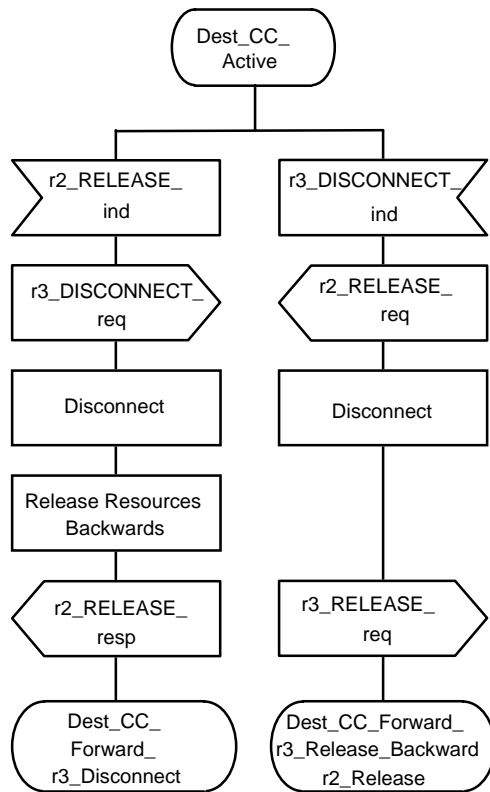

Figure 49 – Stage 2 SDL diagram for Destination CC functional entity (Sheet 5 of 10)

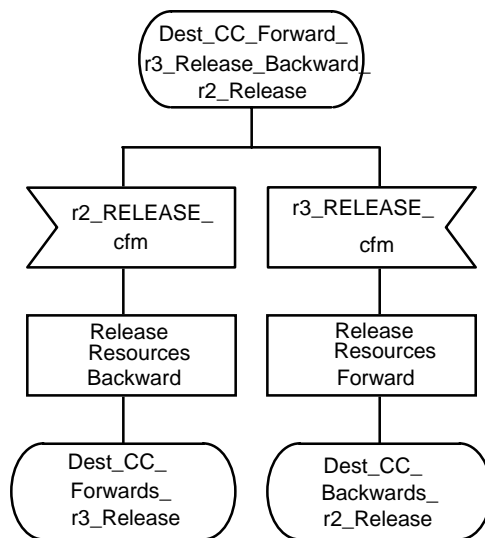

Figure 50 – Stage 2 SDL diagram for Destination CC functional entity (Sheet 6 of 10)

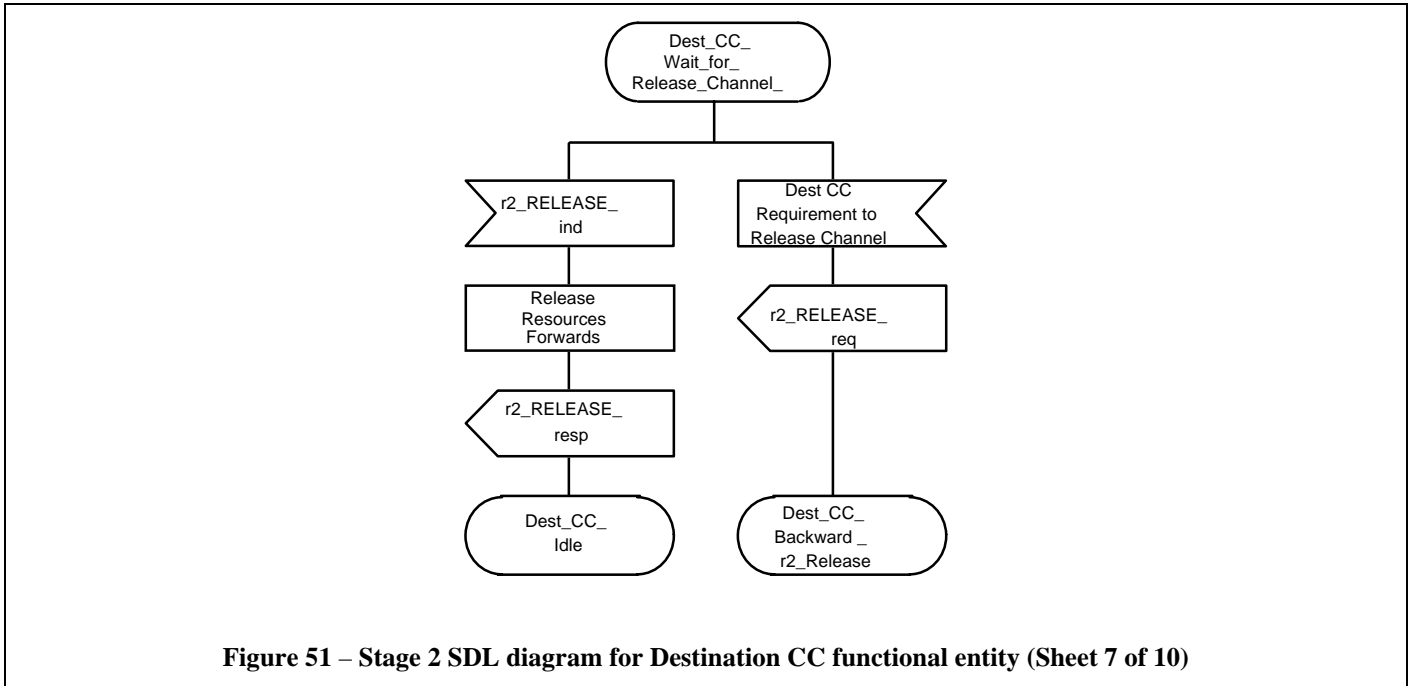

Figure 51 – Stage 2 SDL diagram for Destination CC functional entity (Sheet 7 of 10)

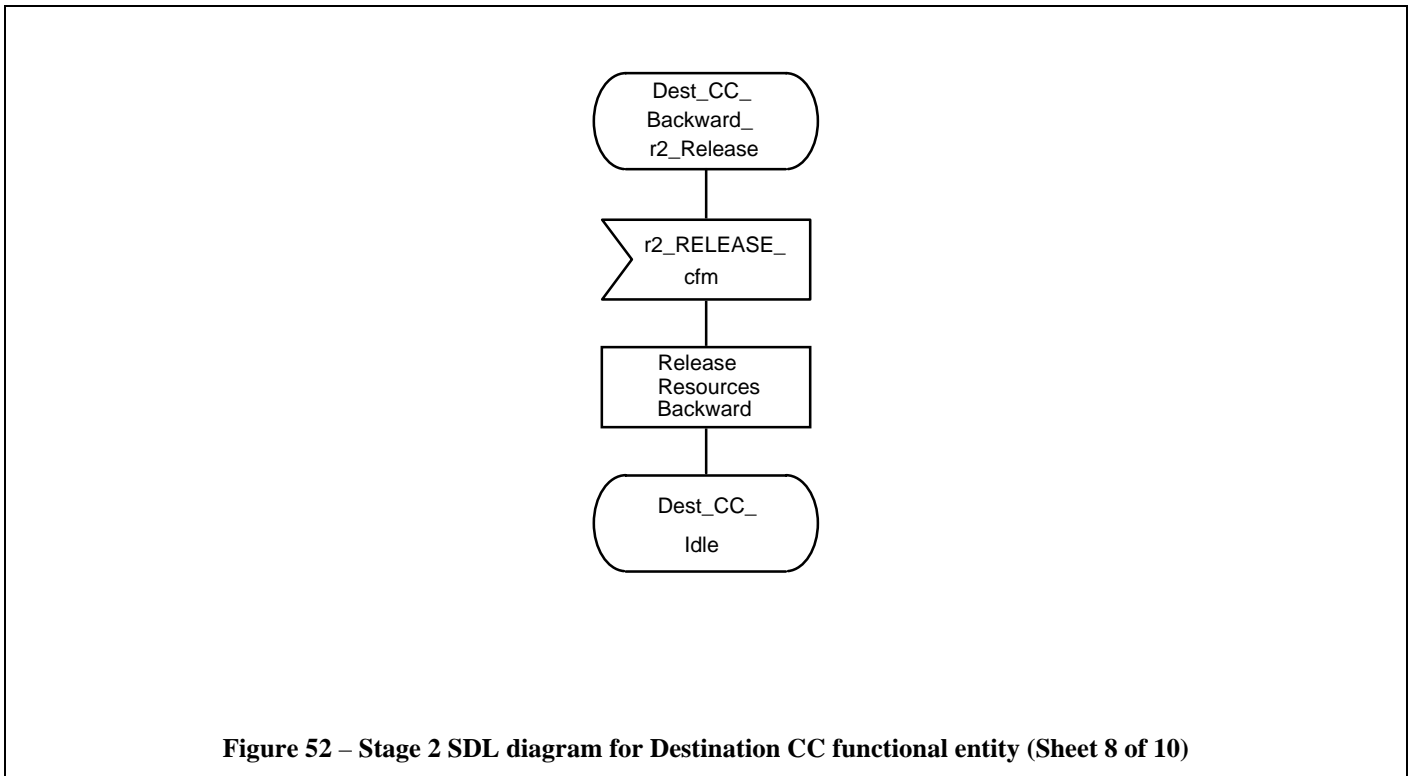

Figure 52 – Stage 2 SDL diagram for Destination CC functional entity (Sheet 8 of 10)

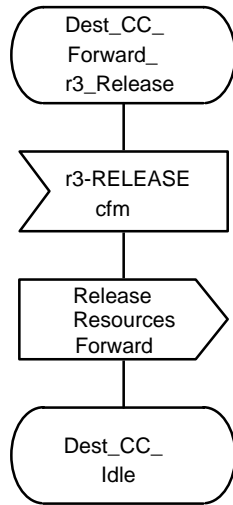

Figure 53 – Stage 2 SDL diagram for Destination CC functional entity (Sheet 9 of 10)

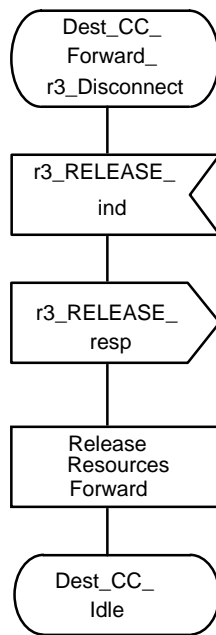

Figure 54 – Stage 2 SDL diagram for Destination CC functional entity (Sheet 10 of 10)

15.5 Destination CCA functional entity SDL diagrams

Output signals to the left and input signals from the left represent information flows across r3 to and from the Destination CC functional entity. Output signals to the right and input signals from the right represent primitives to and from the Destination PISN user. The only exception to this rule is when the text within the signals explicitly identifies from what function the signal originates.

15.5.1 Destination CCA states used in SDL diagrams

- **Dest_CCA_Idle** - No Call in progress
- **Dest_CCA_Call_Sent** - Call has been initiated by the CC, the channel has been reserved to the PISN user, and Destination PISN user response is awaited.
- **Dest_CCA_Call_Active** - Call is in active phase.
- **Dest_CCA_Backward_r3_Release** - Resources have been disconnected, and clearing of the resources in the backward direction has been initiated, CCA awaiting response from the preceding CC.
- **Dest_CCA_Backward_Release_Backward_r3_Disconnect** - Disconnection has been initiated, CCA awaiting response from Destination PISN user.
- **Dest_CCA_Forward_Release_Forward_r3_Disconnect** - Disconnection has been initiated, CCA awaiting response from Destination CC.
- **Dest_CCA_Pending_Channel_Confirmation** - Call has been accepted, CCA awaiting to be awarded the call.

15.5.2 Destination CCA SDL diagrams

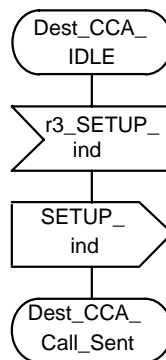

Figure 55 – Stage 2 SDL diagram for Destination CCA functional entity (Sheet 1 of 7)

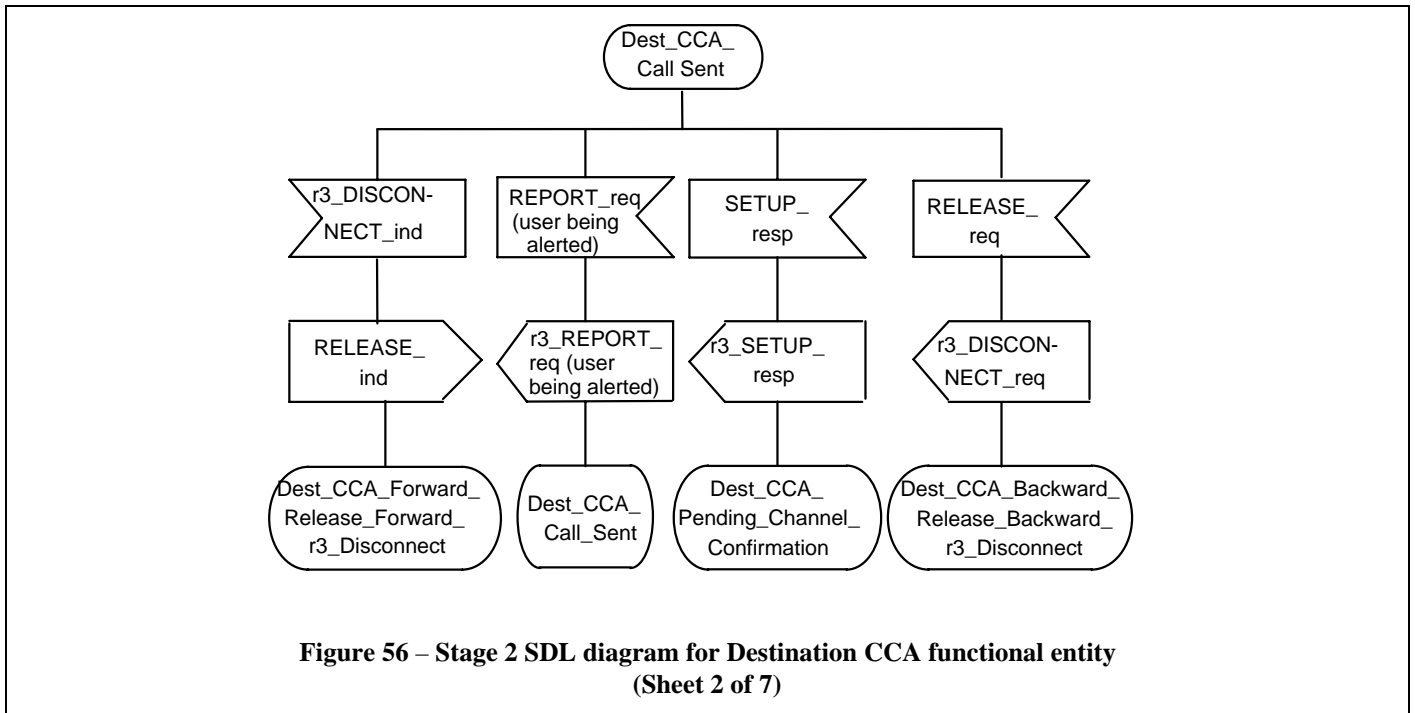

Figure 56 – Stage 2 SDL diagram for Destination CCA functional entity (Sheet 2 of 7)

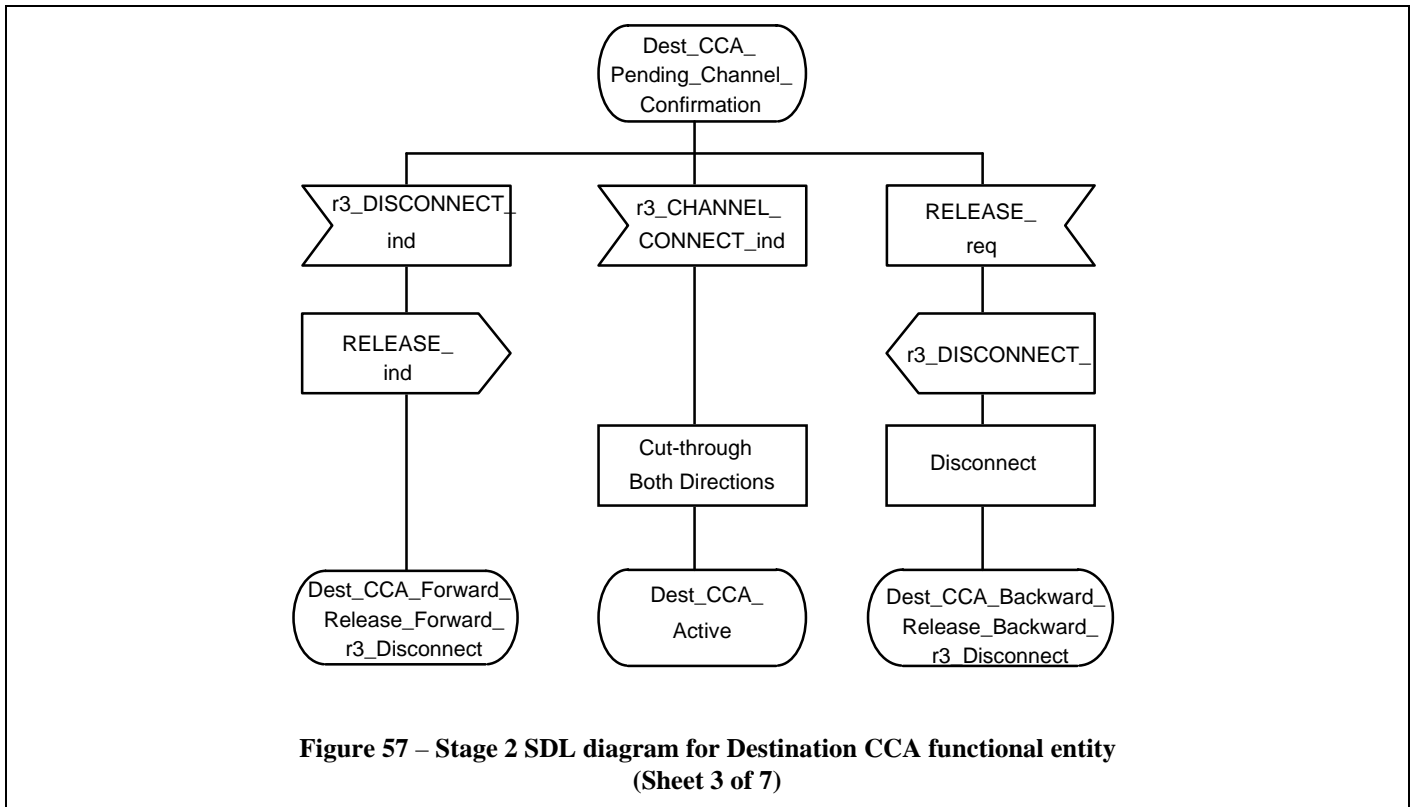

Figure 57 – Stage 2 SDL diagram for Destination CCA functional entity (Sheet 3 of 7)

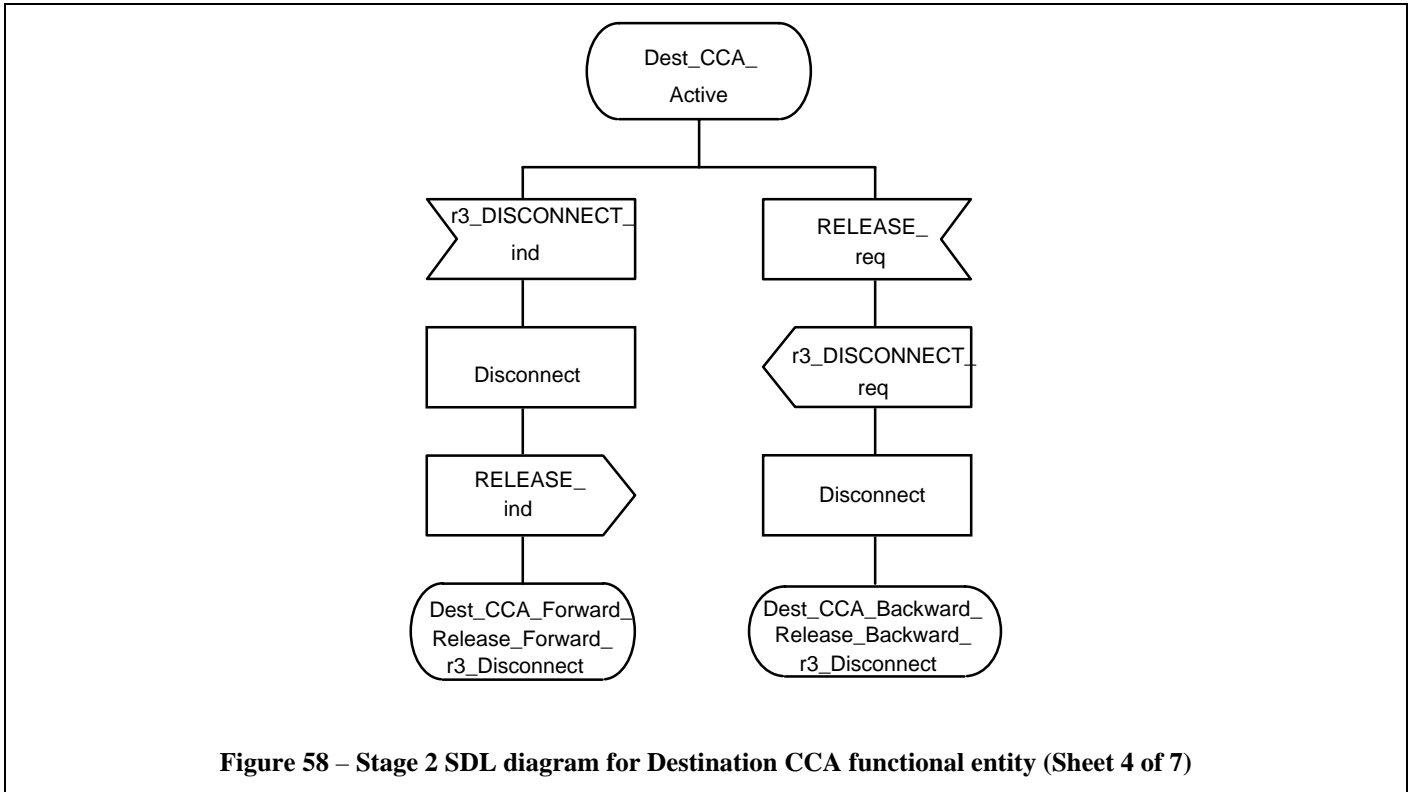

Figure 58 – Stage 2 SDL diagram for Destination CCA functional entity (Sheet 4 of 7)

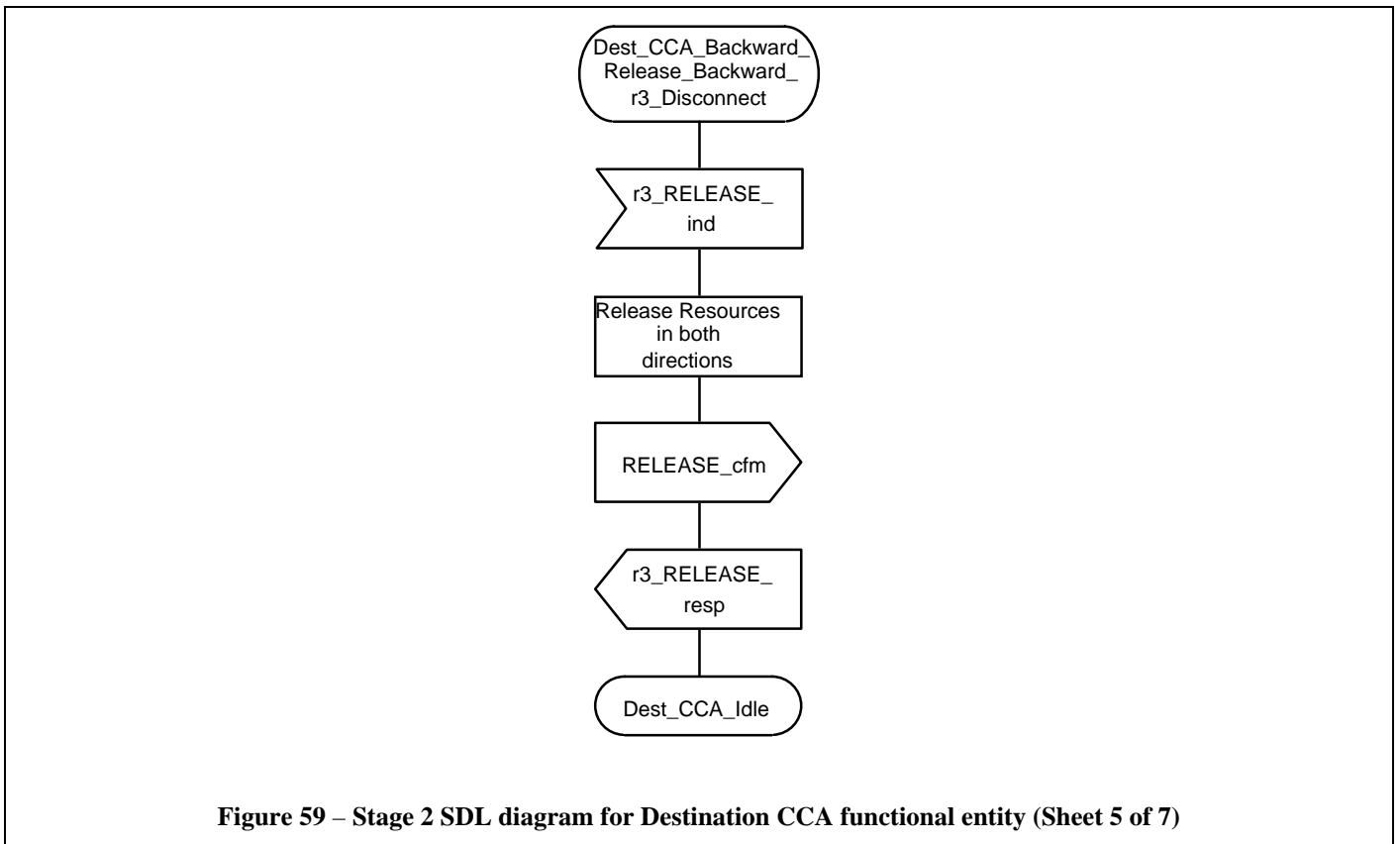

Figure 59 – Stage 2 SDL diagram for Destination CCA functional entity (Sheet 5 of 7)

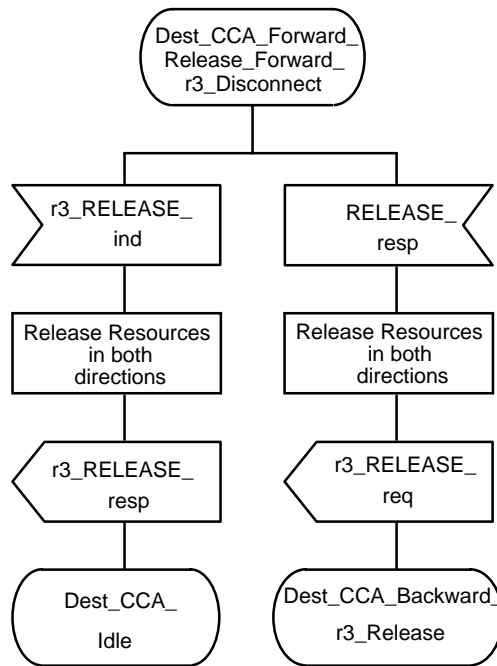

Figure 60 – Stage 2 SDL diagram for Destination CCA functional entity (Sheet 6 of 7)

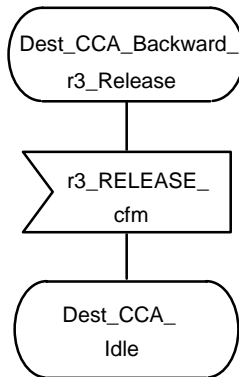

Figure 61 – Stage 2 SDL diagram for Destination CCA functional entity (Sheet 7 of 7)

16 Allocation of functional entities to physical entities

The allocations of the functional elements to physical locations are shown in table 10.

Table 10 – Allocation of FEs to physical entities

Functional Entities									
1. Intra-PISN Call (note 3)	1.1	TE (note 1)					TE	
	1.2	TE							TE
	1.3	TE	 (note 1)				TE	
	(note 2) 1.4	TE							TE
2. Outgoing Call to other network	2.1	TE	- - (note 1) - -						
	(note 2) 2.2	TE							
	2.3	TE							
3. Incoming Call from other network	3.1						- - (note 1) - -	TE	
	(note 2) 3.2							TE	
	3.3							TE	
4. PISN Transit Call	4.1				(note 1)				
	(note 2) 4.2								
	4.3								
	(note 2) 4.4								

Legend: PINX = Private Integrated services Network Exchange
 I/C Gateway CC = Incoming Gateway CC
 O/G Gateway CC = Outgoing Gateway CC
 TE = Terminal Equipment Type 1, Terminal Adaptor together with Terminal Equipment Type 2

NOTE 1
 Entities connected by a dashed line are physically collocated.

NOTE 2
 Transit CC can be allocated physically to either one or multiple, concatenated PINXs.

NOTE 3
 A tandem outgoing and incoming call is to be considered as two separate PISN calls and not an intra-PISN call (see scenarios 2 and 3 above).

Annex A

(normative)

Service attributes

For each specific service category described in clauses 6, 7 and 8 the attributes, as described in ITU-T Recommendations I.140 and I.210, are given. Bearer services are described by low layer attributes. Teleservices are described by both low layer attributes and high layer attributes. High layer attributes are outside the scope of this Standard.

The low layer attributes described in ITU-T recommendation I.210 consist of information transfer attributes, access attributes and general attributes. The information transfer attributes define the network capabilities for transferring information between PISN users of the service. The access attributes define the way in which PISN functions are accessed at the S reference point. Access attributes may differ for different PISN users in a call. General attributes are not used in this Standard.

Information transfer attributes are sub-divided into dominant attributes, defining bearer service categories, and secondary attributes, defining individual bearer services within a category.

The dominant information transfer attributes are:

1. Information transfer mode,
2. Information transfer rate,
3. Information transfer capability,
4. Structure.

The secondary information transfer attributes are:

5. Establishment of communication (note 73),
6. Symmetry (note 74),
7. Communication configuration (note 75).

The access attributes are:

8. Access channel and rate (note 76),
9. Access protocols (note 76).

NOTES

73. *Only demand services are specified in this Standard. Reserved and permanent services may be the subject of future Standards.*
74. *Only bi-directional symmetric services are specified in this Standard. Unidirectional services may be the subject of future Standards.*
75. *Only point-to-point services are specified in this Standard. Multi-point basic services may be the subject of future Standards. Multi-point may, however, be provided in conjunction with some bearer service categories by means of conference call supplementary services.*
76. *The access attributes refer only to the user information, not the signalling information.*

Annex B

(normative)

Teleservices

B.1 General

A PISN can support teleservices requiring the same bearer capabilities as the bearer services specified in this Standard. These teleservices include for example:

- Telephony 3,1 kHz teleservice;
- Telefax group 4 teleservice; and,
- Circuit-mode syntax-based videotex teleservice.

The support by a PISN of one or more of these teleservices is optional. However, if a PISN supports one or more of these teleservices then it shall comply with this annex.

The bearer capabilities and other special requirements used to support these teleservices are specified below. Otherwise, the impact of these teleservices on the network is the same as for the corresponding bearer service.

The PISN shall convey an indication of the teleservice being used as High Layer Compatibility information, from the calling PISN user to the called PISN user. Any use of this indication by the PISN is outside the scope of this Standard.

A PISN may reject a request for a teleservice if the requested bearer capabilities are not those specified in this annex.

NOTE 77

Additional information can be found in the following ETSs:

ETS 300 111 (Telephony 3,1 kHz);

ETS 300 120 (Telefax group 4); and,

ETS 300 262 (Circuit-mode syntax-based videotex).

NOTE 78

The support of other teleservices is not precluded. ETR 018 and ETR 076 contain guidance regarding other teleservices that can be supported using the bearer capabilities defined by this Standard.

High layer functions for interworking between these teleservices and non-ISDN networks are beyond the scope of this Standard.

B.2 Telephony 3,1 kHz teleservice

When this teleservice is required, the bearer capability requested shall comply with the low layer attributes specified in table B.1 below.

Table B.1 - Low layer attributes for telephony 3,1 kHz teleservice

	Low layer attribute	Attribute value
1)	Information transfer mode:	circuit
2)	Information transfer rate:	64 kbit/s
3)	Information transfer capability:	speech (note 1)
4)	Structure:	8 kHz integrity
5)	Establishment of communication:	demand
6)	Symmetry:	bi-directional symmetric
7)	Communication configuration:	point-to-point
8)	Access channel (note 2):	B
9)	Access protocol (note 2):	ITU-T Recommendation G.711 (A-law or μ -law).
NOTE 1: In interworking situations the information transfer capability can default to 3,1 kHz audio.		
NOTE 2: Attribute refers only to the user information, and not to the signalling information.		

B.3 Telefax group 4 teleservice

When this teleservice is required, the bearer capability requested shall comply with the low layer attributes specified in table B.2 below.

Table B.2 - Low layer attributes for telefax group 4 teleservice

	Low layer attribute	Attribute value
1)	Information transfer mode:	circuit
2)	Information transfer rate:	64 kbit/s
3)	Information transfer capability:	unrestricted
4)	Structure:	unstructured (note 1)
5)	Establishment of communication:	demand
6)	Symmetry:	bi-directional symmetric
7)	Communication configuration:	point-to-point
8)	Access channel (note 2):	B
9)	Access protocol (note 2):	ISO/IEC 7776 & ISO/IEC 8208 (note 3)
NOTE 1: Even if no structure is required, the network may provide 8 kHz integrity.		
NOTE 2: Attribute refers only to the user information, and not to the signalling information.		
NOTE 3: The use of a packet-mode bearer capability to support this teleservice is outside the scope of this edition of this Standard.		

B.4 Circuit-mode syntax-based videotex teleservice

When this teleservice is required, the bearer capability requested shall comply with the low layer attributes specified in table B.3 below.

Table B.3 - Low layer attributes for circuit-mode syntax-based videotex teleservice

Low layer attribute		Attribute value
1)	Information transfer mode:	circuit
2)	Information transfer rate:	64 kbit/s
3)	Information transfer capability:	unrestricted
4)	Structure:	unstructured (note 1)
5)	Establishment of communication:	demand
6)	Symmetry:	bi-directional symmetric
7)	Communication configuration:	point-to-point
8)	Access channel (note 2):	B
9)	Access protocol (note 2):	ISO/IEC 7776 & ISO/IEC 8208 (note 3)
NOTE 1:	Even if no structure is required, the network may provide 8 kHz integrity.	
NOTE 2:	Attribute refers only to the user information, and not to the signalling information.	
NOTE 3:	The use of a packet-mode bearer capability to support this teleservice is outside the scope of this edition of this Standard.	

Difference from ISO/IEC 11574

Annex B is modified from that in ISO/IEC 11574.

The title of annex B in the ISO/IEC International Standard is: Telephony Teleservice.

The text of annex B in the ISO/IEC International Standard is:

A PISN can support teleservices that require the same bearer capabilities as the bearer services specified in this Standard. The bearer capabilities and other special requirements used to support the telephony teleservice are specified below. Otherwise the impact of the telephony teleservice on the network is the same as for the corresponding bearer service.

The support by a PISN of the telephony teleservice is optional, however if a PISN supports the telephony teleservice then it shall comply with this annex.

The PISN shall convey an indication of the telephony teleservice as High Layer Compatibility information, from the calling PISN user to the called PISN user. Any use of this indication by the PISN is outside the scope of this Standard.

A PISN may reject a request for the telephony teleservice if the requested bearer capabilities are not those specified in this annex.

NOTE 77

Additional information about this teleservices below can be found in ITU-T Recommendation I.241.1

High layer functions for interworking between this teleservice and non-ISDN networks are beyond the scope of this Standard.

The bearer capability shall comply with the following low layer attributes:

- | | | |
|----|----------------------------------|------------------------------|
| 1. | Information transfer mode: | circuit |
| 2. | Information transfer rate: | 64 kbit/s |
| 3. | Information transfer capability: | speech (note) |
| 4. | Structure: | 8 kHz integrity |
| 5. | Establishment of communication: | demand |
| 6. | Symmetry: | bi-directional symmetric |
| 7. | Communication configuration: | point-to-point |
| 8. | Access channel (note 2): | B |
| 9. | Access protocol (note 2): | G.711 (A-law or μ -law). |

NOTES

78. *In interworking situations the information transfer capability can default to 3,1 kHz Audio.*

79. *The access attributes refer only to the user information not the signalling information.*

End of Difference

Annex C

(informative)

Bibliography

The ITU-T Recommendations listed in this annex are informative and considered useful for the understanding of this Standard. Most of these recommendations refer to similar functions which are provided by public ISDNs.

- ITU-Recommendation I.130 – Method for the characterisation of telecommunication services supported by an ISDN and network capabilities of an ISDN
- ITU-T Recommendation I.220 – Common dynamic description of basic telecommunication services
- ITU-T Recommendation I.230 – Definition of bearer services
- ITU-T Recommendation I.231 – Circuit mode bearer services categories
- ITU-T Recommendation I.240 – Definition of teleservices
- ITU-T Recommendation I.241.1 – Telephony Teleservice supported by an ISDN
- Recommendation Q.65 – Stage 2 of the method for the characterisation of services supported by an ISDN
- ITU-T Recommendation Q.71 – ISDN 64 kbit/s circuit mode switched bearer services
- ITU-T Recommendation X.25 – Packet mode
- ITU-T Recommendation X.75 – Packet-switched Signalling Systems between Public Networks providing Data Transmission services
- ETR 018 "Integrated Services Digital Network (ISDN); Application of the Bearer Capability (BC), High Layer Compatibility (HLC) and Low Layer Compatibility (LLC) information elements by terminals supporting ISDN services" 4th edition (1995)
- ETR 076 "Integrated Services Digital Network (ISDN); Standards guide" 3rd edition (1995)
- ETS 300 111 "Integrated Services Digital Network (ISDN); Telephony 3,1 kHz teleservice Service description" (1992)
- ETS 300 120 "Integrated Services Digital Network (ISDN); Service requirements for telefax group 4" (1992)
- ETS 300 262 "Integrated Services Digital Network (ISDN); Syntax-based Videotex teleservice Service description" (1993)

Difference from ISO/IEC 11574

The last five references above are not contained in the ISO/IEC International Standard.

End of Difference

Annex D
(informative)

Errors in ISO/IEC 11574

Difference from ISO/IEC 11574

This annex is not part of the ISO/IEC International Standard.

End of Difference

D.1 Changes applied to this Standard

This Standard contains changes relative to ISO/IEC 11574 which result from corrections of obvious errors in ISO/IEC 11574. Annex D lists these changes.

The majority of these changes are to correct minor editorial problems. However, where there is a technical change, this is indicated and the rationale is given.

The changes are as follows:

D.1.1 Amendments to clause 1

- In Note 1, change "64 kbits/s" to "64 kbit/s".
- In Note 2, add "the " before "time of publication".

D.1.2 Amendments to clause 2.2

Move references Rec. I.130 and Rec. Q.65 to annex C since they are not mentioned in other clauses.

D.1.3 Amendment to clause 3.5

Delete the dot after "network".

D.1.4 Amendments to clause 4

- Capitalize the first letters F and E in "functional entity".
- Change "Network_Exchange" to "Network Exchange".

D.1.5 Amendment to clauses 5 and 5.1

Change "Services" to "services" in the title line of clauses 5 and 5.1.

D.1.6 Amendment to clause 5.2

In the penultimate line of the 2nd paragraph, insert the word "of" after the word "scope".

D.1.7 Amendment to clause 5.5

In the bullet list below the REPORT primitive, move " and" from the last bullet to the end of the last-but-one bullet.

D.1.8 Amendment to clause 6.2

In the 2nd bulleted paragraph, move the comma to the end of the text in brackets and add a full stop at the end of the sentence.

D.1.9 Amendment to clause 6.5.1

In the title of clause 6.5.1, change the word "network" to "networks".

D.1.10 Amendment to clause 6.5.3

In the 2nd paragraph, replace the words "a analogue network" by "an analogue network".

D.1.11 Amendment to clause 6.6

In the first line, change the word "attribute" to "attributes".

D.1.12 Amendment to clause 7.5.1

In the title of clause 7.5.1, change the words "Digital Networks" to "digital networks".

D.1.13 Amendment to clause 7.6

In the first line, change the word "attribute" to "attributes".

D.1.14 Amendments to clause 8.1

- In the 2nd paragraph, insert the word "etc." after the words "speech processing devices, ".
- In Note 23, delete the word "International" and change the word "Standard" to "standard".

D.1.15 Amendment to clause 8.5.1

In the title of clause 8.5.1, change the words "Digital Networks" to "digital networks".

D.1.16 Amendment to clause 8.5.2

In the last line, change the word "provides" to "provide".

D.1.17 Amendment to clause 8.6

In the first line, change the word "attribute" to "attributes".

D.1.18 Amendments to clause 9.2.1

- In item (g), change the ";" to a full stop;
- in the paragraph preceding Note 31, change "always" to "always".

D.1.19 Amendment to clause 9.2.2

In item (d), change ";;" to ";" at the end of the line.

D.1.20 Amendment to clause 9.2.3

At the end of the first paragraph, the colon should not be underlined.

D.1.21 Amendment to clause 10.1.2, Note 37

In note 37, insert the word "the" before the words "called user" and change the word "limited" to "limited".

D.1.22 Amendments to clause 10.1.3

- Replace the words "user, and when the call" by "user and the call";
- in Note 38, insert commas before and after the words "for example".

D.1.23 Amendments to clause 10.2.1

- In item (a) of clause 10.2.1, replace the word "PISN" by "public ISDN".
- In items (c) and (d) of clause 10.2.1, replace "e.g" by "e.g.,".

D.1.24 Amendments to clause 10.2.3

- In item (a) of clause 10.2.3, delete the words "and optionally pass on if provided".

Rationale: The words appear to be superfluous.

- In the last paragraph, change "I.251.1" to "I.251.5".

D.1.25 Amendment to clause 10.2.4

Replace the word "Report_indication" by "REPORT_indication".

D.1.26 Amendment to clause 12.2.2.4

Insert the word "the" before the words "access functional entity".

D.1.27 Amendment to clause 13.2

At the end of the first paragraph, insert a fullstop (period) after the words "Table 2".

D.1.28 Amendment to clause 13.2, Table 1

Technical change: The information content of SETUP_response/confirmation incorrectly shows the inclusion of the Connection Type Service Element as "not applicable"; it should be shown as "optional".

In the response/confirmation column of Table 1, in the row for CT Connection Type, replace "-", by "O".

D.1.29 Amendments to clause 13.2, Table 2

In table 2, in the row for CT Connection Type:

- in the 1st column, the words "3,1 kHz audio" are incorrectly spaced;
- in the 2nd column, insert the words "Low layer compatibility - o" before the words "Information transfer mode";
- in the 3rd column, the words "Low layer compatibility - o" should all appear on the same line.

D.1.30 Amendment to clause 13.6

Correct the spelling of the word "invite".

D.1.31 Amendment to clause 13.8

In the first sentence, change "r1, r2 and r3" to "r1 and r2".

D.1.32 Amendment to clause 13.9, Table 9

In the middle column, change "r1, r2" to "r1, r2, r3".

D.1.33 Amendment to clause 13.10, Table 10

In the middle column, change "r1, r2, r3" to "r1, r2".

D.1.34 Amendment to clause 14.1.1

In "Function 016", change "PROCEEDING_indication" to "r1_PROCEEDING_indication" and "primitive" to "r1_PROCEEDING_request".

D.1.35 Amendments to clause 14.1.2

In "Function 103", change "shall cut-through" to "shall be cut-through".

In "Function 115", delete the word "primitive".

In "Function 117", change the text to "The r2_PROCEEDING_indication is processed. A r1_PROCEEDING_request is sent to the Originating CCA."

D.1.36 Amendments to clause 14.1.3

In item (c) of "Function 200", insert a space before each of the 2 left bracket characters, "(".

In item (d) of "Function 200", change "contained in the r2_SETUP, " to "contained in the r2_SETUP_indication, ".

In the second sentence of "Function 202", change "r2_REPORT_indication" to "r2_REPORT_request".

In the last sentence of "Function 203", change "Connect Number Subaddress" to "Connected Subaddress".

In the second sentence of "Function 206" and "Function 207", change "r2_REPORT " to "r2_REPORT_request ".

In "Function 216":

- in item (a), replace the space character after the word "INFORMATION" by an underline character, "_";
- in item (b), change "r2_INFORMATION indication" to "r2_INFORMATION_request";
- make the bulleted paragraph below item (b) an item (c) and change "PROCEEDING_request" to "r2_PROCEEDING_request".

D.1.37 Amendments to clause 14.1.4

In clause 14.1.4:

- in item (d) of "Function 300" and item (c) of "Function 315", delete "Originating Subaddress, ";
Rationale: Transport of this element across relationship r3 is outside the scope of this Standard.
- in item (c) of "Function 303", delete the word "Number" from "Connected Number Subaddress";
- in item (a) of "Function 310", delete the characters "ISO/IEC ";
- in item (a) of "Function 315", replace the space character after the word "INFORMATION" by an underline character, "_".

D.1.38 Amendment to clause 14.1.5

In item (b) of "Function 410", delete the characters "ISO/IEC ".

D.1.39 Amendments to clause 14.1.6

- In "Function 131", delete the last sentence.
Rationale: Contradicts the first sentence and does not belong here.
- In "Function 140", Note 61, change "is" to "are".

D.1.40 Amendment to clause 14.2, figure 6

Remove the letters "rq" from rightmost column.

D.1.41 Amendments to clause 14.3

- Delete the word "with" from "and with when";
- in figure 7, add the list of elements to the SETUP_res/cfm flow across r1 and r2, and add a comma between "DS" and "CI" in the list of elements below r3_SETUP_req/ind.

D.1.42 Amendment to clause 14.4, figure 8

Complete the arrow on top representing relationship r1.

D.1.43 Amendment to clause 14.6, figure 10

Remove the letters "r1" from above the leftmost arrow on top.

D.1.44 Amendments to clause 14.9, figure 13

- Add the missing annotation "r3_RELEASE" in the rightmost column;
- in the Note, change "r1" to "r1/r3" in both sentences.

D.1.45 Amendment to clause 14.10, figure 14

In Note 1, change "non-ISDN" to "public network".

D.1.46 Amendments to clause 14.11, figure 15

- Delete ",CH" from the list of elements below flow r2*_REPORT_req/ind in the rightmost column;
- in Note 1, change "non-ISDN" to "public network".

D.1.47 Amendments to clause 15.1.1

- In the third bullet item, add a comma after "PISN user";
- In the fourth bullet item, correct the spelling of "originated";
- In the fifth bullet item, add a comma after "CCA".

D.1.48 Amendment to clause 15.1.2, figure 23

Delete the third input symbol.

Rationale: Is the same as the first input, which seems more correct. Alternatively, the leftmost branch could be removed, and the third input could connect to the rightmost branch.

D.1.49 Amendments to clause 15.2.1

- In the seventh bullet item, change "preceding CC" to "Originating CCA";
- in the last-but-one bullet item, change "responses" to "response".

D.1.50 Amendments to clause 15.2.2

- In figure 28, change "Proceeding" to all upper case (twice in the middle branch);
- in figure 29, the correct state at the end of the leftmost branch is "Orig_CC_Backward_r1_Release_Forward_r2_Release";
- in figure 36, the correct state at the end of the left branch is "Orig_CC_Forward_r2_Release".

D.1.51 Amendments to clause 15.3.2

- In figure 39, the correct state at the end of the leftmost branch is "Transit_CC_Forward_r2_Release";
- in figure 40, the 3rd state symbol on the bottom must say "Transit_CC_Call_Sent";
- in figure 42, the state symbol on top must say "Transit_CC_Active".

D.1.52 Amendment to clause 15.4.1

In the 2nd bullet item, delete "a " from "awaits a responses".

D.1.53 Amendments to annex A

- In item 6., change "note 2" to "note 74";
- in item 7., change "note 74" to "note 75";
- in item 8., change "note 75" to "note 76".

D.1.54 Amendment to annex C

Delete reference to ITU-T Rec. X.31, as it is already contained in clause 2.

D.2 Open problems which were not corrected in this Standard

The following items are issues not yet resolved in this Standard.

D.2.1 Clause 2.2

The dates of all ITU-T references need checking and possible update.

D.2.2 Amendment to clause 5.3, Note 10

Insert a fullstop (period) after the words "NOTE 10".

NOTE: This change is not applicable to this Standard due to different formatting.

D.2.3 Amendments to clause 9.2.1

Technical change: The existing text is incorrect for a number of reasons:

1. *the text states is optional for the Network Call Control (NCC) entity to convey the items of information listed in the bullet points to the calling PISN user. In fact, it is optional for the called user to supply them; if supplied to the NCC entity. they must be conveyed to the calling PISN user;*
2. *HLC information would not be available in the backward direction at this point in call establishment unless HLC selection procedures were being used - the scope of the International Standard specifically states that the negotiation of service at call establishment time is outside the scope;*
3. *The sentence: "The called user may use the LLC and HLC information for compatibility checking." is out of context here, as the paragraph is dealing with behaviour at the calling side.*

The changes proposed correct these 3 problems, as well as 2 editorial problems.

In the last paragraph of clause 9.2.1, replace the text:

"The confirmation may optionally contain:

- the connected PISN user's subaddress,
- the Lower (sic) Layer Compatibilty (sic) information, and
- High Layer Compatibility information

if they have been provided. The called user may use the LLC and HLC information for compatibility checking."

by:

"The confirmation shall contain:

- the connected PISN user's subaddress, and/or
- the Low Layer Compatibility information,

if either were contained in the SETUP_response sent by the called PISN user."

and insert a paragraph break before the sentence beginning "For certain service categories".

D.2.4 Amendment to clause 9.2.2

Technical change: see 9.2.1 above (rationale item 2).

In the last paragraph of clause 9.2.2, replace the text ", low layer compatibility information and high layer compatibility information." by "and/or low layer compatibility information."

D.2.5 Amendment to clause 9.2.3

Technical change: The word "may" is incorrect, implying that the ability to release the call using RELEASE_request is an implementation option The word "can" would be more correct, implying that either PISN user has the ability to release the call and that if this ability is exercised then RELEASE_request is used. Two sentences would be the best solution, however.

Replace the sentence beginning "The call may be released ..." by "The call can be released by either of the PISN users. A PISN user shall release a call by transferring a request for release (RELEASE_request) across its service access point."

D.2.6 Amendment to clause 14.6

Rationale: The figure for outgoing interworking in 14.7 has a note to explain what the content of the CH service element should be; there is no similar note for the incoming interworking case. Closer examination shows that the note needs to be more complex than the note already existing in 14.7.

Replace the existing note after the figure with the following:

"NOTES -

1. CH (Call History) in the r2_SETUP_request/indication information flows contains the service parameter: "Signalling interworking: non-common channel signalling system". In the r3_SETUP_request/indication information flow CH contains the service parameter: "Interworking encountered".
2. The RT (Report Type) in this sequence is "User being alerted".

D.2.7 Amendment to clause 14.7

Technical change: The use of the phrase "interworking with non-ISDN marker", is technically incorrect and thus confusing. The proper name of the stage 2 service parameter should be used here. Closer examination also reveals that the content of CH varies according to the relationship.

Replace note 1 by the following:

1. CH (Call History) in the r2_REPORT_request/indication information flows contains the service parameter: "Signalling interworking: non-common channel signalling system". In the

r1_REPORT_request/indication information flow CH contains the service parameter: "Interworking encountered".

D.2.8 Amendment to clause 14.10

Technical change: Note 1 is wrong - see above.

Replace note 1 by the following:

1. The CH (Call History) service element, if present, contains either the "Signalling interworking: non-common channel signalling system" service parameter, or the "Interworking encountered" service parameter.

D.2.9 Amendment to clause 14.11

Technical change: Note 1 is wrong - see above.

Replace note 1 by the following:

1. The CH (Call History) service element, if present, contains either the "Signalling interworking: non-common channel signalling system" service parameter, or the "Interworking encountered" service parameter.

D.2.10 Clause 15.5

Compared with the first edition of this Standard, some "Disconnect" action boxes have been removed in ISO/IEC 11574.

Printed copies can be ordered from:

ECMA

114 Rue du Rhône
CH-1204 Geneva
Switzerland

Fax: +41 22 849.60.01

Internet: documents@ecma.ch

Files can be downloaded from our FTP site, [ftp.ecma.ch](ftp://ftp.ecma.ch), logging in as **anonymous** and giving your E-mail address as **password**. This Standard is available from library **ECMA-ST** as a compacted, self-expanding file in MSWord 6.0 format (file E142-DOC.EXE) and as an Acrobat PDF file (file E142-PDF.PDF). File E142-EXP.TXT gives a short presentation of the Standard.

Our web site, <http://www.ecma.ch>, gives full information on ECMA, ECMA activities, ECMA Standards and Technical Reports.

ECMA

**114 Rue du Rhône
CH-1204 Geneva
Switzerland**

This Standard ECMA-142 is available free of charge in printed form and as a file.

See inside cover page for instructions