

**E C M A**

**EUROPEAN COMPUTER MANUFACTURERS ASSOCIATION**

---

**STANDARD ECMA-143**

**PRIVATE TELECOMMUNICATION NETWORK (PTN)**

-

**INTER-EXCHANGE SIGNALLING PROTOCOL**

-

**CIRCUIT MODE BASIC SERVICES**

**(QSIG-BC)**

Free copies of this document are available from ECMA,  
European Computer Manufacturers Association,  
114 Rue du Rhône - CH-1204 Geneva (Switzerland)

Phone: +41 22 735 36 34 Fax: +41 22 786 52 31



**E C M A**

**EUROPEAN COMPUTER MANUFACTURERS ASSOCIATION**

---

**STANDARD ECMA-143**

**PRIVATE TELECOMMUNICATION NETWORK (PTN)**

-

**INTER-EXCHANGE SIGNALLING PROTOCOL**

-

**CIRCUIT MODE BASIC SERVICES**

**(QSIG-BC)**





## Brief History

This Standard is one of a series of ECMA Standards defining services and signalling protocols applicable to Private Telecommunication Networks (PTNs). The series uses the ISDN concepts as developed by CCITT and is also within the framework of standards for open systems interconnection as defined by ISO.

The protocol defined in this Standard is the basis for the QSIG protocol for signalling at the Q reference point between Private Telecommunication Network Exchanges (PTNXs). Whilst this particular ECMA Standard defines signalling for the support of circuit-mode bearer services, other ECMA Standards specify other aspects of QSIG, e.g. generic procedures for the support of supplementary services and individual supplementary services.

QSIG is independent of the scenario used to interconnect PTNXs (see ENV 41006), and is based on Digital Subscriber Signalling System No. 1 (DSS1), adapted for intra-PTN use.

The Standard is based upon the practical experience of ECMA member companies and the results of their active and continuous participation in the work of ISO, CCITT, ETSI and other international and national standardization bodies. It represents a pragmatic and widely based consensus.

Compared to the First Edition of Standard ECMA-143, various changes have been made for alignment with ETS 300 172 (which is based on the First Edition of ECMA-143 but modified during Public Enquiry) and a change has been made to the value of timer T310. In addition, a Protocol Implementation Conformance Statement (PICS) proforma has been added (annex D), and the Conformance clause has been modified accordingly.

This ECMA Standard has been contributed to ETSI for processing to a Second Edition of ETS 300 172.





## Table of contents

	<b>Page</b>
<b>Section I - General</b>	<b>1</b>
<b>1 Scope</b>	<b>1</b>
<b>2 Field of application</b>	<b>1</b>
<b>3 Conformance</b>	<b>1</b>
<b>4 References</b>	<b>1</b>
<b>5 Definitions and Acronyms</b>	<b>2</b>
5.1 Definitions	2
5.1.1 General	2
5.1.2 Side, Incoming Side and Outgoing Side (see figure 1)	2
5.1.3 Outgoing Call and Incoming Call	2
5.1.4 Originating PTNX, Terminating PTNX and Transit PTNX (see figure 1)	2
5.1.5 Gateway PTNX, Incoming Gateway PTNX and Outgoing Gateway PTNX (see figure 1)	3
5.1.6 Preceding PTNX and Subsequent PTNX	3
5.1.7 Unrecognised Message	3
5.1.8 Unexpected Message	3
5.1.9 Unrecognised information element	3
5.1.10 information elements with Invalid Contents	3
5.2 Acronyms	3
<b>6 General principles</b>	<b>4</b>
6.1 Protocol Model	5
6.2 Services Provided to Call Control	6
6.3 Services Required of the Data Link Layer	6
6.4 Protocol Control States	6
6.4.1 States for Circuit Mode Call Control	6
6.4.2 States for Layer Management	7
6.5 Message Segmentation and Reassembly Functions	8
6.5.1 States for Message Segmentation and Reassembly Procedures	8
6.6 Call Control	9
6.6.1 States for Transit PTNX Call Control	9

<b>Section II - Procedures</b>	<b>11</b>
<b>7 General procedures</b>	<b>11</b>
7.1 Use of the Services of Layer 2	11
7.1.1 Establishment of a Data Link Connection	11
7.1.2 Transfer of Data	11
7.1.3 Data Link Reset	11
7.1.4 Data Link Failure	11
7.2 Message Segmentation Procedures	11
7.2.1 Procedures for Message Segmentation	11
7.2.2 Procedures for Message Reassembly	12
7.2.3 SDL for Message Segmentation and Reassembly (informative)	13
7.3 Handling of protocol error conditions	17
7.3.1 Protocol discriminator error	17
7.3.2 Message too short	17
7.3.3 Call reference error	17
7.3.4 Message type or message sequence errors	17
7.3.5 General information element errors	18
7.3.6 Mandatory information element errors	18
7.3.7 Non-mandatory information element errors	19
7.3.8 Data Link reset	20
7.3.9 Data Link failure	20
7.4 Status and Status Enquiry Protocol Procedures	21
7.4.1 Status Enquiry procedure	21
7.4.2 Receiving a STATUS message	21
<b>8 Circuit-Switched Call Control Procedures</b>	<b>23</b>
8.1 Call establishment	23
8.1.1 Call request	23
8.1.2 B-channel selection	24
8.1.3 Overlap sending	24
8.1.4 Call Proceeding	25
8.1.5 Call confirmation indication	25
8.1.6 Call connected	26
8.1.7 Use of the PROGRESS message	26
8.1.8 Failure of Call Establishment	27
8.2 Call clearing	27
8.2.1 Terminology	27
8.2.2 Exception conditions	27
8.2.3 Clearing	28
8.2.4 Clear Collision	28



8.3	Call Collisions	28
8.4	Protocol Control SDL Diagram (informative)	29
8.5	Transit PTNX Call Control requirements	52
8.5.1	Receipt of Address Information	53
8.5.2	State TCC_Await Digits	53
8.5.3	State TCC_Await Additional Digits	54
8.5.4	State TCC_Overlap	54
8.5.5	Channel Through Connection Procedures	55
8.5.6	State TCC_Incoming Call Proceeding	55
8.5.7	State TCC_Transit Call Proceeding	56
8.5.8	State TCC_Call Alerting	57
8.5.9	State TCC_Call Active	57
8.5.10	Clearing at a Transit PTNX	57
8.5.11	Handling of Basic Call information elements at a Transit PTNX	58
8.6	Transit Call Control SDL Diagrams (informative)	59
8.7	Originating PTNX Call Control Requirements	78
8.7.1	Transmission of the SETUP message	78
8.7.2	Agreement of the B-channel	79
8.7.3	Receipt of progress indicators	79
8.7.4	Receipt of ALERTING Message	79
8.7.5	Receipt of CONNECT Message	80
8.7.6	Call Clearing Initiated by the Originating PTNX	80
8.7.7	Receipt of an Indication of Call Clearing	80
8.8	Terminating PTNX Call Control Requirements	80
8.8.1	Receipt of the SETUP message	80
8.8.2	Transmission of ALERTING Message	81
8.8.3	Transmission of progress indicators	81
8.8.4	Transmission of CONNECT Message	81
8.8.5	Call Clearing Initiated by the Terminating PTNX	82
8.8.6	Receipt of an Indication of Call Clearing	82
8.9	Incoming Gateway PTNX Call Control Requirements	82
8.9.1	Transmission of the SETUP message	82
8.9.2	Interworking Indications in the SETUP Message	83
8.9.3	Agreement of the B-channel	84
8.9.4	Receipt of progress indicators	84
8.9.5	Receipt of ALERTING Message	84
8.9.6	Receipt of CONNECT Message	84
8.9.7	Call Clearing Initiated by the Incoming Gateway PTNX	85
8.9.8	Receipt of an Indication of Call Clearing	85
8.10	Outgoing Gateway PTNX Call Control Requirements	85
8.10.1	Receipt of the SETUP message	85
8.10.2	Connection of the B-channel	86

8.10.3	Transmission of Interworking Indications	86
8.10.4	Transmission of ALERTING Message	87
8.10.5	Transmission of CONNECT Message	88
8.10.6	Call Clearing Initiated by the Outgoing Gateway PTNX	88
8.10.7	Receipt of an Indication of Call Clearing	89
<b>9</b>	<b>Procedures For Layer Management</b>	<b>89</b>
9.1	Restart Procedures	89
9.1.1	Sending RESTART	89
9.1.2	Receipt of RESTART	89
9.1.3	Restart Collision	89
<b>10</b>	<b>Protocol Timers</b>	<b>90</b>
	<b>Section III - Messages</b>	<b>92</b>
<b>11</b>	<b>Functional Definition and Content of Messages</b>	<b>92</b>
11.1	Messages for General Procedures	92
11.1.1	STATUS	92
11.1.2	STATUS ENQUIRY	93
11.2	Messages for Circuit Mode Call Control	93
11.2.1	ALERTING	93
11.2.2	CALL PROCEEDING	94
11.2.3	CONNECT	94
11.2.4	CONNECT ACKNOWLEDGE	95
11.2.5	DISCONNECT	95
11.2.6	INFORMATION	95
11.2.7	PROGRESS	96
11.2.8	RELEASE	96
11.2.9	RELEASE COMPLETE	97
11.2.10	SETUP	97
11.2.11	SETUP ACKNOWLEDGE	98
11.3	Messages for Layer Management	98
11.3.1	RESTART	98
11.3.2	RESTART ACKNOWLEDGE	99
<b>12</b>	<b>General message format and coding of information elements</b>	<b>99</b>
12.1	Overview	99
12.2	Protocol discriminator	100
12.3	Call Reference	100
12.4	Message type	102
12.5	Other information elements for Basic Call Control (Codeset 0)	103

12.5.1	Coding rules	103
12.5.2	Extension of codesets	105
12.5.3	Locking shift procedure	106
12.5.4	Non-locking shift procedure	107
12.5.5	Bearer capability	107
12.5.6	Call state	109
12.5.7	Called party number	110
12.5.8	Called party subaddress	112
12.5.9	Calling party number	112
12.5.10	Calling party subaddress	113
12.5.11	Cause	113
12.5.12	Channel identification	119
12.5.13	Connected number	121
12.5.14	Connected subaddress	121
12.5.15	High layer compatibility (Layers 4 - 7)	121
12.5.16	Lower layer compatibility (Layers 1 - 3)	122
12.5.17	Progress indicator	122
12.5.18	Restart indicator	124
12.5.19	Segmented message	124
12.5.20	Sending complete	125
12.6	Information elements of Codeset 5	125
12.6.1	Party category	126
12.6.2	Transit counter	126
<b>Annex A - Use of the Cause information element</b>		<b>129</b>
<b>Annex B - Examples of Message Sequences</b>		<b>133</b>
<b>Annex C - Manufacturer Specific Information</b>		<b>137</b>
<b>Annex D - Protocol Implementation Conformance Statement (PICS) Proforma</b>		<b>139</b>
<b>Annex E - Relationship to ETS 300 172</b>		<b>151</b>





## Section I - General

### 1 Scope

This Standard defines the Layer 3 protocol for signalling for the support of circuit mode bearer services (used either on their own or in support of teleservices) at the Q reference point between Private Telecommunication Network Exchanges (PTNX) connected together within a Private Telecommunication Network (PTN). The Q reference point is defined in ENV 41004.

Service specifications are produced in three stages and according to the method specified in ENV 41005. The definition of signalling protocols is stage 3 of the method. Stage 1 and stage 2 specifications of the basic circuit mode bearer services are to be found in ETS 300 171. The protocol defined in this Standard satisfies the requirements identified by the stage 1 and stage 2 specifications in ETS 300 171.

### 2 Field of application

This Standard is applicable to PTNXs which interconnect to form a PTN.

### 3 Conformance

In order to conform to this Standard, a PTNX shall satisfy the requirements identified in the Protocol Implementation Conformance Statement (PICS) Proforma in annex D.

### 4 References

ECMA-133	Reference Configurations for Calls through Exchanges of Private Telecommunication Networks (1989)
ECMA-134	Method for the Specification of Basic and Supplementary Services of Private Telecommunication Networks (1989)
ECMA-135	Scenarios for Interconnections between Exchanges of Private Telecommunication Networks (1989)
ECMA-141	Data Link Layer Protocol at the Q Reference Point for the Signalling Channel between Two Private Telecommunication Network Exchanges (1990)
ECMA-142	Specification, Functional Model and Information Flows for Control Aspects of Circuit Mode Basic Services in Private Telecommunication Networks (1990)
ECMA-148	Identification Supplementary Services in Private Telecommunication Networks - Specification, Functional Model and Information Flows (1990)
ECMA-155	Addressing in Private Telecommunication Networks (1991)
ETS 300 102-1:1990	Integrated Services Digital Network (ISDN); User-network interface layer 3; Specifications for basic call control
ETS 300 170:1992	Private Telecommunication Network (PTN); Inter-exchange signalling, Data link layer protocol
ETS 300 171:1992	Private Telecommunication Network (PTN); Specification, functional models and information flows, Control aspects of circuit mode basic services
ETS 300 173:1992	Private Telecommunication Network (PTN); Specification, functional models and information flows, Identification supplementary services
ETS 300 189:1992	Private Telecommunication Network (PTN); Addressing
ENV 41004:1989	Reference configuration for connectivity relations of private telecommunication network exchanges

ENV 41005:1989	Method for the specification of basic and supplementary services of private telecommunication networks
ENV 41006:1989	Scenarios for interconnections between exchanges of private telecommunication networks
ENV 41007-1:1989	Definition of terms in private telecommunication networks. Part 1: Definition of general terms
CCITT Rec. E.163:1988	Numbering plan for the international telephone service
CCITT Rec. E.164:1988	Numbering plan for the ISDN era
CCITT Rec. I.112:1988	Vocabulary of terms for ISDNs
CCITT Rec. I.330:1988	ISDN numbering and addressing principles
CCITT Rec. Q.930:1988	ISDN user-network interface layer 3 - general aspects
CCITT Rec. Q.931:1988	ISDN user-network interface layer 3 specification for basic call control
CCITT Rec. T.50:1988	International alphabet no. 5

*NOTE 1*

*Some of the ETSs and ENVs above are based on ECMA Standards, although there is not always complete technical alignment. The relationships are as follows:*

<u>ETSI/ENV</u>	<u>ECMA Standard</u>
ETS 300 170	ECMA-141
ETS 300 171	ECMA-142
ETS 300 173	ECMA-148
ETS 300 189	ECMA-155
ENV 41004	ECMA-133
ENV 41005	ECMA-134
ENV 41006	ECMA-135

## 5 Definitions and Acronyms

### 5.1 Definitions

#### 5.1.1 General

For the purpose of this Standard the special terminology defined in ENV 41007-1 and I.112 applies. If there is conflict, the definitions in ENV 41007-1 shall take precedence.

#### 5.1.2 Side, Incoming Side and Outgoing Side (see figure 1)

The term Side is used to describe either of the two PTNXs at each end of an inter-PTNX link, and in particular to describe the protocol entity within a PTNX.

In the context of a call, the Outgoing Side is the Side which routes the call over the inter-PTNX link and the Incoming Side is the Side which receives the call.

#### 5.1.3 Outgoing Call and Incoming Call

From the point of view of the Outgoing Side a call is an Outgoing Call.

From the point of view of the Incoming Side a call is an Incoming Call.

#### 5.1.4 Originating PTNX, Terminating PTNX and Transit PTNX (see figure 1)

Within the context of a call, the PTNX to which the calling user is attached is known as the Originating PTNX.

Within the context of a call, the PTNX to which the called user is attached is known as the Terminating PTNX.

Within the context of a call, any PTNX through which the call passes, excluding the Originating PTNX or Incoming Gateway PTNX and the Terminating PTNX or Outgoing Gateway PTNX, is known as a Transit PTNX.



**5.1.5 Gateway PTNX, Incoming Gateway PTNX and Outgoing Gateway PTNX (see figure 1)**

Within the context of a call, a PTNX which performs interworking between the signalling system specified in this Standard and another signalling system, either ISDN or non-ISDN, is known as a Gateway PTNX.

A Gateway PTNX which routes an incoming call from a route employing another signalling system on to an inter-PTNX link employing the signalling system specified in this Standard is known as an Incoming Gateway PTNX.

A Gateway PTNX which routes an incoming call from an inter-PTNX link employing the signalling system specified in this Standard on to a route employing another signalling system is known as an Outgoing Gateway PTNX.

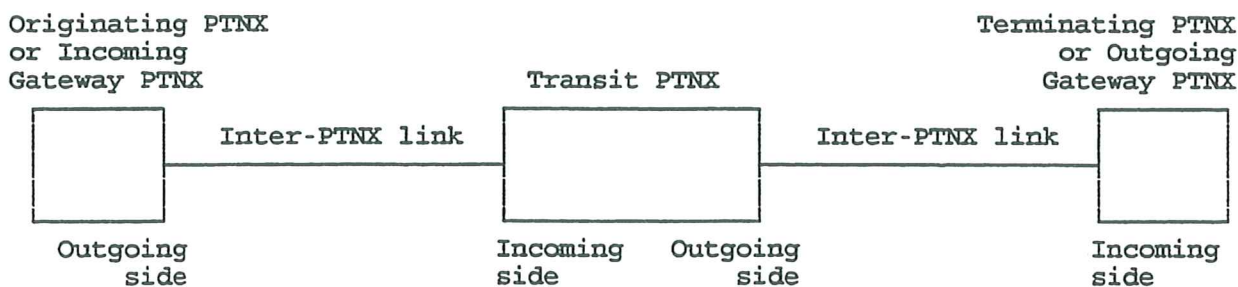

**Figure 1 - Illustration of Terminology through Example of a Call Routed over Two Inter-PTNX Links**

**5.1.6 Preceding PTNX and Subsequent PTNX**

Within the context of a call, from the point of view of a PTNX acting as the Incoming Side of an inter-PTNX link, the PTNX at the other end of the link, acting as the Outgoing Side, is known as the Preceding PTNX.

Within the context of a call, from the point of view of a PTNX acting as the Outgoing Side of an inter-PTNX link, the PTNX at the other end of the link, acting as the Incoming Side, is known as the Subsequent PTNX.

**5.1.7 Unrecognised Message**

A message which is not specified in clause 11 of this Standard or in any other standard that extends the protocol defined in this Standard to which the PTNX claims conformance (e.g. a standard specifying generic procedures for supplementary services).

**5.1.8 Unexpected Message**

Within the context of a particular Protocol Control state, a message which is recognised, but for which no procedures are defined in 7.2, 7.4 and 8 of this Standard (or in any other standard that extends the protocol defined in this Standard to which the PTNX claims conformance) for receipt in that Protocol Control state.

**5.1.9 Unrecognised information element**

An information element received in a particular message which is not specified as part of that message in clause 11 of this Standard or in any other standard that extends the protocol defined in this Standard to which the PTNX claims conformance (e.g. a standard specifying generic procedures for supplementary services).

**5.1.10 information elements with Invalid Contents**

An information element which is recognised, but whose contents cannot be interpreted as valid using the rules specified in clause 12 of this Standard, or the standard in which the information element is defined, or contains field values which are marked as 'reserved'.

**5.2 Acronyms**

- ANF Additional Network Feature
- DSS1 Digital Subscriber Signalling System No. 1
- IE information element



ISDN	Integrated Services Digital Network
MP	Mapping (functional grouping)
MSI	Manufacturer Specific Information
PICS	Protocol Implementation Conformance Statement
PTN	Private Telecommunication Network
PTNX	Private Telecommunication Network Exchange
TE	Terminal Equipment

## 6 General principles

The basic call is a single invocation of a basic service. This Standard specifies the signalling procedures for establishing, maintaining and clearing a circuit-mode basic call at an interface between two PTNXs. These signalling procedures are defined in terms of messages exchanged over a data link connection within the D-channel of the inter-PTNX link. The result of successful basic call establishment is a connection for the purpose of user information transfer. This connection uses a B-channel of the inter-PTNX link.

Throughout this Standard, the term B-channel is used to indicate any channel other than the D-channel, e.g. a single 64 kbit/s B-channel, multiple 64 kbit/s B-channels, or an H-channel.

Conceptually, an inter-PTNX link is attached to the Switching and Call Handling functional groupings of a PTNX at the Q reference point, and comprises a D-channel and one or more B-channels. In practice, these channels are provided by bearer services of an intervening network (ISDN or non-ISDN) according to any of the scenarios identified in ENV 41006, e.g. dedicated transmission system, permanent or on demand circuit-switched B and D channels, permanent or on demand circuit-switched B channels and packet-switched D channel. Inter-PTNX signalling relates to the Control Plane of the PTN and is conveyed in the User Plane of the intervening network.

A physical interface does not necessarily exist at the Q reference point. The protocol specified in this Standard is the Layer 3 protocol which would exist at the Q reference point if there were a physical interface. It is therefore independent of the scenario for PTNX interconnection.

The layer 3 protocol at the Q reference point is visible at an interface at the C reference point, subject to any provisions of the relevant standard for the Inter-PTNX connection scenario concerned. Underlying protocols at the interface at C are dependent on the scenario which the intervening network supports, i.e., on the nature of the intervening network and the bearer service(s) provided. The Mapping (MP) functional grouping (see Standard ECMA-133) maps the conceptual D- and B- channels at the Q reference point to physical circuits, timeslots and channels at the interface at the C reference point, and terminates the underlying scenario dependent protocols.

With some scenarios a single physical interface from a PTNX to the intervening network may support links to several other PTNXs. Also some scenarios permit the use on the same interface of other services of the intervening network (i.e. for communication with subscribers of the intervening network other than other PTNXs within the same PTN). Figure 2 illustrates these concepts. Such shared use of a physical interface at C has no impact on the Layer 3 signalling protocol at Q.

For some scenarios, inter-PTNX connections may be established and released, on demand, by the PTNXs concerned. Although protocols exist for this purpose at interfaces at the C reference point, such protocols relate to the Control Plane of the intervening network. They are terminated within the MP functional grouping and do not appear at the Q reference point.

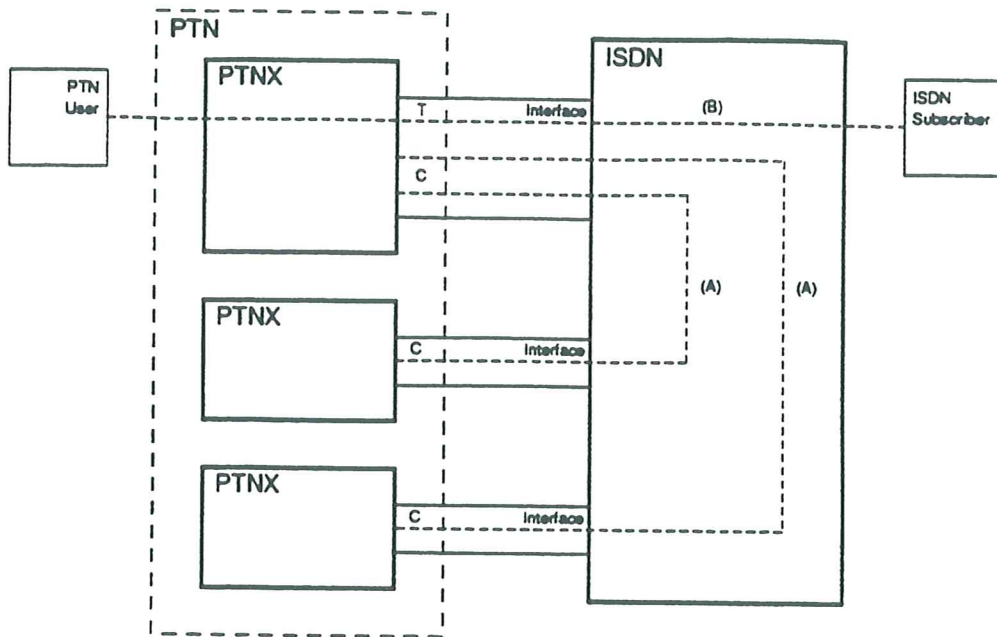

- Legend: (A) - Examples of service providing closed communication between two PTNXs in a PTN  
 (B) - Example of service providing communication between a PTN user and a subscriber in the open ISDN

Figure 2 - Shared Use of an ISDN Interface

The basic call signalling procedures specified in this Standard apply to circuit mode bearer services, used either on their own or in support of teleservices.

In addition, this Standard includes signalling procedures for layer management, including restart procedures.

### 6.1 Protocol Model

Figure 3 shows the relationship, within the Control Plane, between the Layer 3 protocol at Q and the adjacent layers.

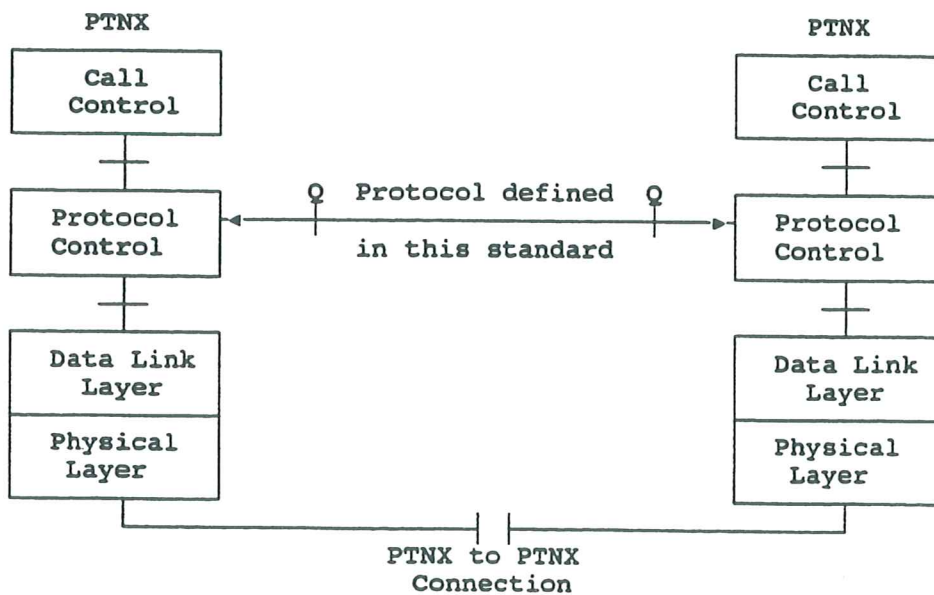

Figure 3 - Control Plane Protocol Model



The Protocol Control entity provides services to Call Control. Call Control corresponds to the Call Control functional entity identified for the basic call at Stage 2 (see ETS 300 171). Primitives exchanged across the boundary between Call Control and Protocol Control correspond to the information flows exchanged between the Call Control functional entities, as identified at Stage 2. Protocol Control provides the mapping between these primitives and the messages transferred across the inter-PTNX link.

In order to transfer messages, Protocol Control uses the services of the Data Link Layer, which in turn uses the services of the Physical Layer. The actual Data Link Layer and Physical Layer protocols visible at the C reference point are dependent upon the PTNX interconnection scenario.

## 6.2 Services Provided to Call Control

Protocol Control provides services to Call Control whereby Call Control can send information flows to and receive information flows from the peer Call Control. A primitive from Call Control to Protocol Control of type "request" or "response" normally results in the associated information flow being presented to the peer Call Control as a primitive of type "indication" or "confirmation" respectively. The following primitives are used:

- SETUP-REQUEST/INDICATION/RESPONSE/CONFIRMATION for the establishment of a call;
- MORE\_INFORMATION-REQUEST/INDICATION for requesting more destination addressing information during call establishment;
- INFORMATION-REQUEST/INDICATION for providing more destination addressing information during call establishment;
- PROCEED-REQUEST/INDICATION for indicating that sufficient destination addressing information has been received and call establishment is proceeding;
- ALERTING-REQUEST/INDICATION for indicating that the destination user is being alerted;
- PROGRESS-REQUEST/INDICATION for indicating interworking conditions and/or the availability of in-band patterns;
- REJECT-REQUEST/INDICATION for the immediate rejection of a call;
- DISCONNECT-REQUEST/INDICATION for the initiation of call release;
- RELEASE-REQUEST/INDICATION for the completion of call release.
- DATA\_LINK\_RESET-INDICATION for indicating to Call Control that a data link reset has occurred.

## 6.3 Services Required of the Data Link Layer

The services required of the Data Link Layer can be defined in terms of the services provided by ETS 300 170. Protocol Control uses the following acknowledged information transfer services and their associated primitives:

- Data Transfer, using the DL-DATA-REQUEST/INDICATION primitives;
- Establishment of Multiple Frame Operation, using the DL-ESTABLISH-REQUEST/INDICATION/CONFIRM primitives;
- Termination of Multiple Frame Operation, using the DL-RELEASE-REQUEST/INDICATION primitives.

These services do not need to be (but may be) provided by the protocol defined in ETS 300 170. Actual provision is scenario dependent.

## 6.4 Protocol Control States

Protocol Control procedures for calls and layer management are specified in terms of (a) messages which are transferred across the inter-PTNX link, (b) the primitives to and from Call Control at each PTNX, (c) the information processing and actions that take place within Protocol Control at each PTNX, and (d) the states that can exist within Protocol Control at each PTNX.

State machines are deemed to exist for each circuit mode call. Further state machines are deemed to exist for layer management.

### 6.4.1 States for Circuit Mode Call Control

The states below are used in association with call references other than the global call reference.

**6.4.1.1 Null State (0)**

No call exists.

**6.4.1.2 Call Initiated (1)**

This state exists for an outgoing call when the Outgoing Side has sent a request for call establishment to the Incoming Side but has not yet received a response.

**6.4.1.3 Overlap Sending (2)**

This state exists for an outgoing call when the Outgoing Side has received acknowledgement that the Incoming Side is able to receive additional call information in overlap mode.

**6.4.1.4 Outgoing Call Proceeding (3)**

This state exists for an outgoing call when the Outgoing Side has received acknowledgement that the Incoming Side has received all call information necessary to effect call establishment.

**6.4.1.5 Call Delivered (4)**

This state exists for an outgoing call when the Outgoing Side has received from the Incoming Side an indication that the called user is being alerted.

**6.4.1.6 Call Present (6)**

This state exists for an incoming call when the Incoming Side has not yet responded to the request from the Outgoing Side for call establishment.

**6.4.1.7 Call Received (7)**

This state exists for an incoming call when the Incoming Side has indicated to the Outgoing Side that the called user is being alerted.

**6.4.1.8 Connect Request (8)**

This state exists for an incoming call when the Incoming Side has indicated to the Outgoing Side that the called user has answered the call.

**6.4.1.9 Incoming Call Proceeding (9)**

This state exists for an incoming call when the Incoming Side has sent to the Outgoing Side acknowledgement that it has received all call information necessary to effect call establishment.

**6.4.1.10 Active (10)**

This state exists for an incoming call when the Incoming Side has received from the Outgoing Side an acknowledgement of the indication that the called user has answered the call. This state exists for an outgoing call when the Outgoing Side has received from the Incoming Side an indication that the called user has answered the call.

**6.4.1.11 Disconnect Request (11)**

This state exists when a Side has sent to the other Side a request to disconnect the user information connection and is waiting for a response.

**6.4.1.12 Disconnect Indication (12)**

This state exists when a Side has received from the other Side a request to disconnect the user information connection and has not yet responded.

**6.4.1.13 Release Request (19)**

This state exists when a Side has sent to the other Side a request to release the call and has not yet received a response.

**6.4.1.14 Overlap Receiving (25)**

This state exists for an incoming call when the Incoming Side has sent acknowledgement to the Outgoing Side that it is able to receive additional call information in overlap mode.

**6.4.2 States for Layer Management**

The states below are used in association with the global call reference.



**6.4.2.1 Null State (Rest 0)**

No transaction exists.

**6.4.2.2 Restart Request (Rest 1)**

This state exists for a restart transaction when the Side has sent a restart request to the other Side but has not yet received an acknowledgement.

**6.4.2.3 Restart (Rest 2)**

This state exists for a restart transaction when the Side has received a restart request from the other Side but has not yet sent an acknowledgement.

**6.5 Message Segmentation and Reassembly Functions**

Message segmentation and reassembly functions are employed where the size of a message exceeds the maximum size of the Data Link Layer information field size. The architectural relationship of segmentation and reassembly functions to other Protocol Control functions is shown in figure 4.

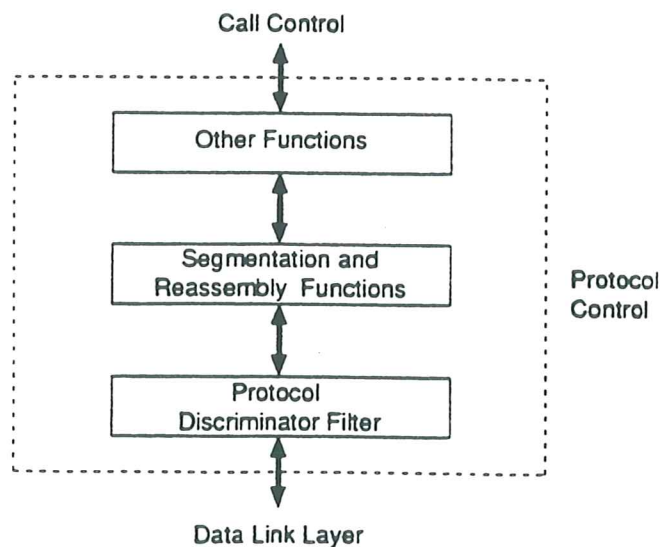

**Figure 4 - Logical Architecture of Protocol Control Showing Segmentation and Reassembly Functions**

Segmentation and reassembly, where provided, effectively constitute a lower sublayer of Protocol Control. The only function of Protocol Control which lies below the segmentation and reassembly functions is the filtering out of messages containing a protocol discriminator which is not in accordance with that specified in this Standard.

The primitives across the boundary between segmentation and reassembly functions and other functions are the same as those between the Data Link Layer and Protocol Control. The segmentation functions act upon DL-DATA-REQUEST primitives by converting, where necessary, a single primitive into two or more primitives before passing to the Data Link Layer. The reassembly functions act upon DL-DATA-INDICATION primitives from the Data Link Layer by converting, where necessary, two or more primitives into a single primitive for passing up to the other functions of Protocol Control. Other primitives to and from the Data Link Layer are not affected by the segmentation and reassembly functions.

**6.5.1 States for Message Segmentation and Reassembly Procedures**

Message segmentation and reassembly procedures are each specified in terms of a state machine. Message segmentation uses a single state, Null (0). Message reassembly uses two states, as listed below.

**6.5.1.1 Null (0)**

No message is being reassembled.

**6.5.1.2 Receiving segmented message (1)**

One or more segments of a segmented message have been received and one or more further segments are awaited.

**6.6 Call Control**

In addition to specifying Protocol Control, this Standard also specifies those aspects of Call Control which are necessary for PTNXs to cooperate in the control of calls through a PTN. Although the behaviour of an Protocol Control entity with respect to a call is dependent on whether the PTNX is the Outgoing Side or the Incoming side of the inter-PTNX link, its behaviour is independent of whether the PTNX is a Transit PTNX, an End (Originating or Terminating) PTNX, or a Gateway PTNX. Call Control requirements, on the other hand, are dependent on whether the PTNX is a Transit PTNX, an Originating PTNX, a Terminating PTNX, an Incoming Gateway PTNX or an Outgoing Gateway PTNX.

8.5 specifies the special Call Control requirements of a Transit PTNX for coordinating the two Protocol Control entities. The requirements of 8.5 are in addition to the requirements of Protocol Control, which are to be satisfied for both the incoming inter-PTNX link and the outgoing inter-PTNX link. An SDL representation of Call Control for a Transit PTNX appears in 8.6.

The special Call Control requirements for Originating PTNXs are specified in 8.7. The requirements of 8.7 are in addition to the requirements of Protocol Control, which are to be satisfied on the outgoing inter-PTNX link.

The special Call Control requirements for Terminating PTNXs are specified in 8.8. The requirements of clause 8.8 are in addition to the requirements of Protocol Control, which are to be satisfied on the incoming inter-PTNX link.

The special Call Control requirements for Incoming Gateway PTNXs are specified in 8.9. The requirements of 8.9 are in addition to the requirements of Protocol Control, which are to be satisfied on the outgoing inter-PTNX link.

The special Call Control requirements for Outgoing Gateway PTNXs are specified in 8.10. The requirements of 8.10 are in addition to the requirements of Protocol Control, which are to be satisfied on the incoming inter-PTNX link.

**6.6.1 States for Transit PTNX Call Control**

The states below are used in association with calls in Call Control of a Transit PTNX.

**6.6.1.1 TCC\_Idle (0)**

No call exists.

**6.6.1.2 TCC\_Await Digits (1)**

This state exists when Call Control has received a request for call establishment from the Preceding PTNX and is awaiting additional call information in order to select a route to the Subsequent PTNX.

**6.6.1.3 TCC\_Await Additional Digits (2)**

This state exists when Call Control has sent a request for call establishment to the Subsequent PTNX and is awaiting possible additional call information from the Preceding PTNX.

**6.6.1.4 TCC\_Overlap (3)**

This state exists when Call Control is awaiting possible additional call information from the Preceding PTNX, having received acknowledgement that the Subsequent PTNX is able to receive additional call information in overlap mode.

**6.6.1.5 TCC\_Incoming Call Proceeding (4)**

This state exists when Call Control has determined that it has received all call information necessary to effect call establishment and has informed the Preceding PTNX, but no response to the request for call establishment have been received from the Subsequent PTNX.



**6.6.1.6 TCC\_Transit Call Proceeding (5)**

This state exists when Call Control has received from the Subsequent PTNX a response to the request for call establishment and is no longer expecting additional call information to pass to the Subsequent PTNX in overlap mode.

**6.6.1.7 TCC\_Call Alerting (6)**

This state exists when Call Control has received from the Subsequent PTNX an indication that the called user is being alerted and has relayed the indication on to the Preceding PTNX.

**6.6.1.8 TCC\_Call Active (7)**

This state exists when Call Control has received from the Subsequent PTNX and relayed on to the Preceding PTNX an indication that the called user has answered the call.

**6.6.1.9 TCC\_Await Incoming Release (8)**

This state exists when Call Control has initiated call clearing towards the Preceding PTNX and is awaiting an acknowledgement.

**6.6.1.10 TCC\_Await Outgoing Release (9)**

This state exists when Call Control has initiated call clearing towards the Subsequent PTNX and is awaiting an acknowledgement.

**6.6.1.11 TCC\_Await Two-Way Release (10)**

This state exists when Call Control has initiated call clearing towards the Preceding PTNX and towards the Subsequent PTNX and is awaiting an acknowledgement from each.

**6.6.1.12 TCC\_Await Incoming Disconnect (11)**

This state exists when Call Control has applied an in-band tone or announcement towards the Preceding PTNX and is awaiting the initiation of clearing procedures.

**6.6.1.13 TCC\_Await Outgoing Disconnect (12)**

This state exists when Call Control has applied an in-band tone or announcement towards the Subsequent PTNX and is awaiting the initiation of clearing procedures.

**6.6.1.14 TCC\_Await Two-Way Disconnect (13)**

This state exists when Call Control has applied an in-band tone or announcement towards both the Preceding PTNX and the Subsequent PTNX and is awaiting the initiation of clearing procedures.

## Section II - Procedures

### 7 General procedures

#### 7.1 Use of the Services of Layer 2

This clause specifies the use of the services of the Data Link Layer.

##### 7.1.1 Establishment of a Data Link Connection

Before the procedures for call control, layer management or any of the general procedures in 7.2 to 7.4 can be performed, a Data Link connection shall be established. If a Data Link connection has not already been established, Protocol Control may request establishment by sending a DL-ESTABLISH-REQUEST primitive to the Data Link Layer. Receipt of a DL-ESTABLISH-CONFIRMATION primitive or a DL-ESTABLISH-INDICATION primitive from the Data Link Layer indicates that a Data Link connection has been established.

##### 7.1.2 Transfer of Data

A message (or message segment) shall be transmitted by including it with a DL-DATA-REQUEST primitive to the Data Link Layer.

A message (or message segment) shall appear included with a DL-DATA-INDICATION primitive from the Data Link Layer.

##### 7.1.3 Data Link Reset

Receipt of a DL-ESTABLISH-INDICATION primitive from the Data Link Layer subsequent to establishment of the data link connection shall indicate a spontaneous Data Link Layer reset. The procedures specified in 7.3.8 shall apply.

##### 7.1.4 Data Link Failure

Receipt of a DL-RELEASE-INDICATION primitive from the Data Link Layer shall indicate a Data Link malfunction. The procedures specified in 7.3.9 shall apply.

#### 7.2 Message Segmentation Procedures

This clause specifies message segmentation and reassembly procedures for messages the length of which exceeds the maximum size of the Data Link Layer information field. The Data Link Layer information field size is dependent on the PTNX interconnection scenario.

A PTNX shall conform to the segmentation procedures specified in 7.2.1 if, for a given PTNX interconnection scenario supported by the PTNX, it is capable of transmitting a message which exceeds the maximum size of Data Link Layer information field for that scenario. Segmentation procedures shall not be applied to messages which do not exceed the maximum size of the Data Link Layer information field.

A PTNX which claims conformance to this Standard shall declare the maximum size of message which it is able to receive. The declared maximum size shall not be less than 260 octets. If, for a given PTNX interconnection scenario supported by the PTNX, the maximum size of Data Link Layer information field is less than the declared maximum size of message which the PTNX can receive, the PTNX shall conform to the reassembly procedures specified in 7.2.2.

If a segmented message is received by a PTNX which does not support reassembly procedures, the procedures specified in 7.3.4 for message type errors shall apply to each received segment.

##### 7.2.1 Procedures for Message Segmentation

The following rules apply when a message exceeds the maximum size of the Data Link Layer information field.

- a) The maximum number of message segments is eight. If a message is too long to be segmented, the action taken shall be an implementation option.
- b) Each message segment shall begin with the protocol discriminator, the call reference, the message type SEGMENT and the information element Segmented message in that order. These shall be followed by one or more octets from the message being segmented, subject to the length of the segment not exceeding the maximum size of the Data Link Layer information field. In the case of the first segment, the octets from



the message being segmented shall commence with the first octet following the message type. In the case of each subsequent segment, the octets from the message being segmented shall commence with the octet following the last octet transmitted in the previous segment.

- c) The first segment indicator field of the Segmented message information element shall be set to ONE (first segment of segmented message) in the first segment of a segmented message and shall be set to ZERO (subsequent segment to first segment) in each subsequent segment of that message.
- d) The number of segments remaining field of the Segmented message information element shall indicate how many more segments are to be sent.
- e) The segmented message type field of the Segmented message information element shall indicate the message type of the unsegmented message.
- f) Once the first segment has been transmitted on a particular data link connection, then all remaining segments of that message shall be sent (in order) before any other message (segmented or not) for any call reference is sent on that data link connection. Only failure conditions, e.g. Data Link failure, shall cause the transmission of a segmented message to be aborted.
- g) The octet order of the segmented message shall be preserved regardless of segment boundary.

#### 7.2.2 Procedures for Message Reassembly

The following rules apply to the receipt and reassembly of segmented messages.

- a) A reassembly function, on receiving a message of type SEGMENT containing the Segmented message information element as the first information element after the message type, shall treat that message as a segment.
- b) A reassembly function in the Null state, on receiving a segment in which the first segment indicator field of the Segmented message information element is set to ONE (first segment of segmented message) and the number of segments remaining field of the Segmented message information element is set to a value greater than 0 and not exceeding 7, shall enter the Receiving segmented message state and save the segment contents. Timer T314 shall be initialised.
- c) A reassembly function in the Receiving segmented message state, on receiving a segment in which the call reference is equal to the call reference of the first segment received, the first segment indicator field of the Segmented message information element is set to ZERO (subsequent segment to first segment), the number of segments remaining field of the Segmented message information element is set to a value one less than the value in the previously received segment, and the segmented message type field has a value equal to the value of that field in the first segment received, shall treat the segment as a valid next segment.
- d) A reassembly function in the Receiving segmented message state, on receiving a valid next segment in which the number of segments remaining field has a value greater than zero, shall save the segment contents along with the saved contents of the previous segment or segments, restart timer T314, and remain in the Receiving segmented message state.
- e) A reassembly function in the Receiving segmented message state, on receiving a valid next segment in which the number of segments remaining field has a value equal to zero, shall stop timer T314, deliver the accumulated segments, including the last segment, as a single message for further Protocol Control processing, and enter the Null state. The message delivered shall have a call reference equal to that in each received segment and a call type equal to that in the segmented message type field of the Segmented message information element of each received segment. Octets following the Segmented message information element in each received segment shall be included in the delivered message in the order received.
- f) A reassembly function in the Null state shall deliver any received message other than a valid first segment for further Protocol Control processing. Any other action taken shall be an implementation option. This applies to the following:
  - Messages of type other than SEGMENT.

- Messages of type SEGMENT without a valid Segmented message information element following the message type.
  - Segments in which the first segment indicator field of the Segmented message information element is set to ZERO (subsequent segment to first segment).
  - Segments in which the number of segments remaining field of the Segmented message information element has a value 0 or a value exceeding 7.
- g) A reassembly function in the Receiving segmented message state shall discard any saved segments, stop timer T314 and enter the Null state on receipt of any message which is not a valid next segment. This applies to the following:
- Messages with a different call reference from that in the first received segment.
  - Messages of type other than SEGMENT.
  - Messages of type SEGMENT without a valid Segmented message information element following the message type.
  - Segments in which the first segment indicator field of the Segmented message information element is set to ONE (first segment of segmented message).
  - Segments in which the number of segments remaining field of the Segmented message information element has a value which is not one less than the value in the previously received segment.
  - Segments in which the segmented message type field of the Segmented message information element has a value which is not equal to the value in the first received segment.
- In the case of a message with a different call reference from that in the first received segment or a message with a message type other than SEGMENT, the received message shall be processed as if it had been received while in the Null state. In all other cases the received message shall be discarded. Any other action taken shall be an implementation option.
- h) On expiry of timer T314, the reassembly function shall discard any saved segments and enter the Null state. Any other action taken shall be an implementation option.
- i) If a DL-RELEASE-INDICATION or DL-ESTABLISH-INDICATION is received while the reassembly function is in the Receiving segmented message state, the reassembly function shall discard any saved segments, stop timer T314, and enter the Null state. The DL-RELEASE-INDICATION or DL-ESTABLISH-INDICATION shall be delivered for further Protocol Control processing.

### 7.2.3 SDL for Message Segmentation and Reassembly (informative)

Figure 5 shows the procedures for message segmentation in SDL form. The SDL process forms part of the Segmentation and Reassembly functions of Protocol Control (see 6.5) and intercepts all primitives sent from Other Functions of Protocol Control towards the Data Link Layer.

Figure 6 shows the procedures for message reassembly in SDL form. The SDL process forms part of the Segmentation and Reassembly functions of Protocol Control (see 6.5) and intercepts all primitives received from the Data Link Layer via the Protocol Discriminator Filter.

In each figure, input signals from the left (except those indicating timer expiry) and output signals to the left are from and to the Other Functions of Protocol Control, and input signals from the right and output signals to the right are from and to the Data Link Layer, via the Protocol Discriminator Filter.



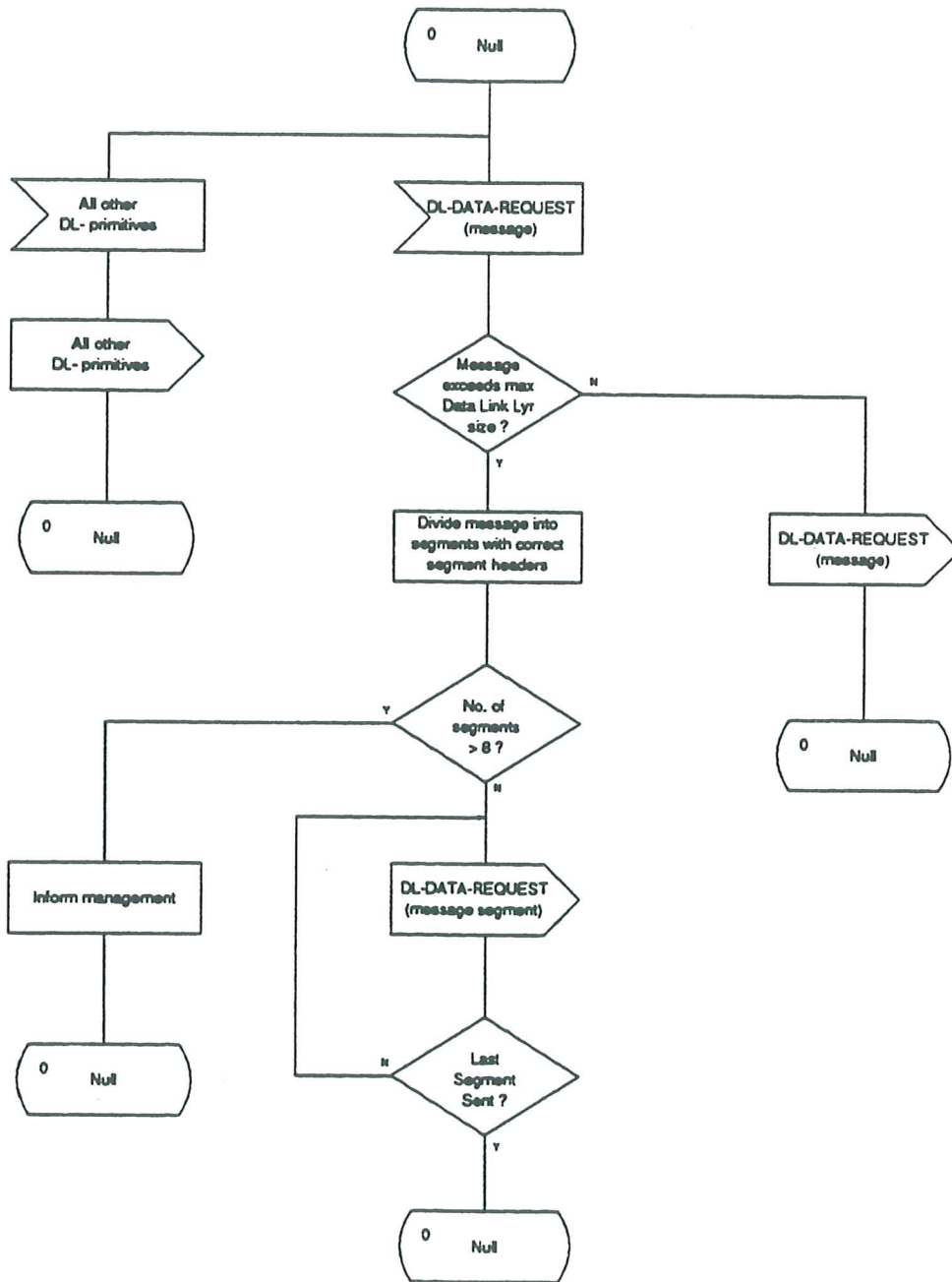

Figure 5 - Segmentation Process SDL



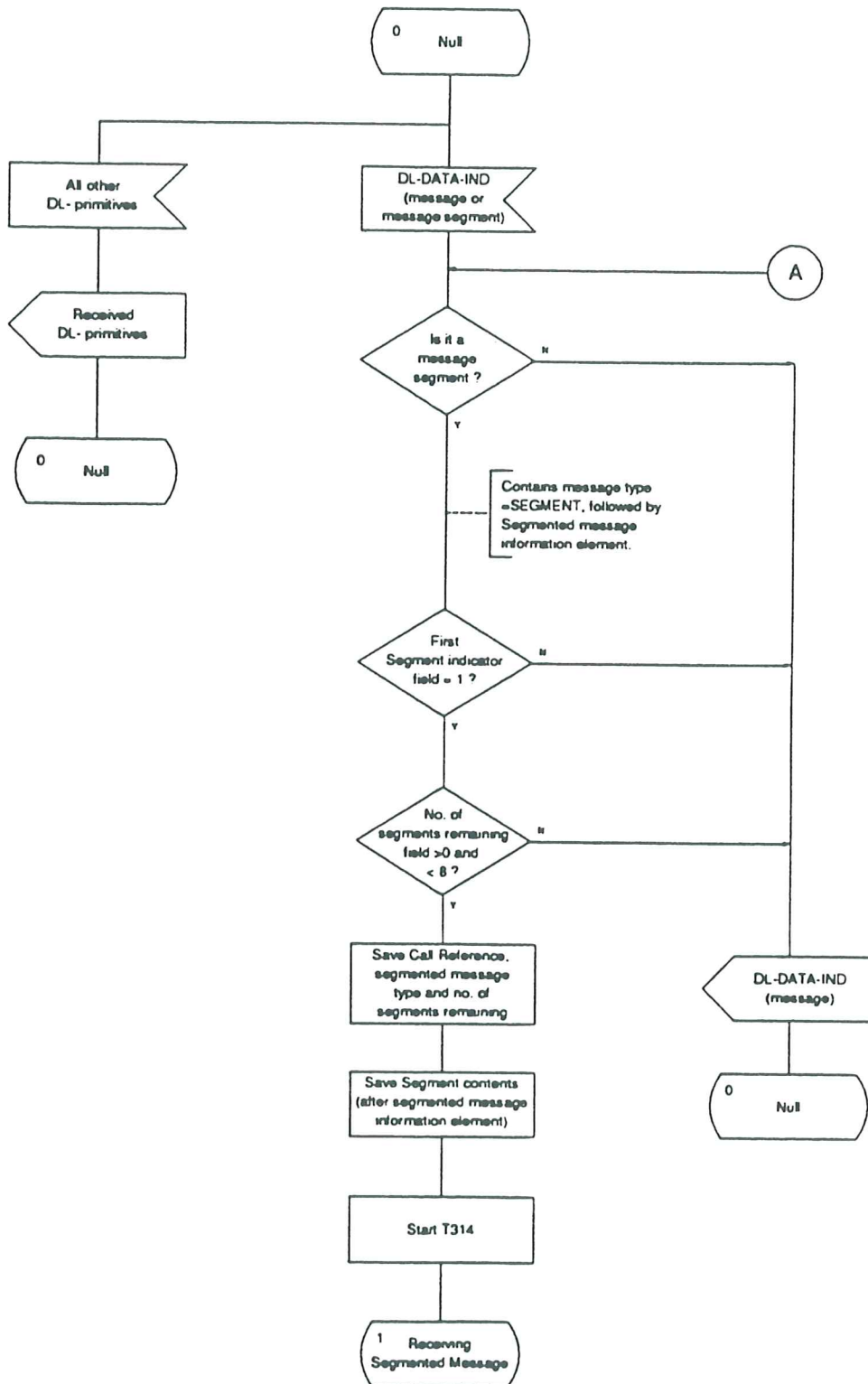

Figure 6 - Reassembly Process SDL (Part 1)

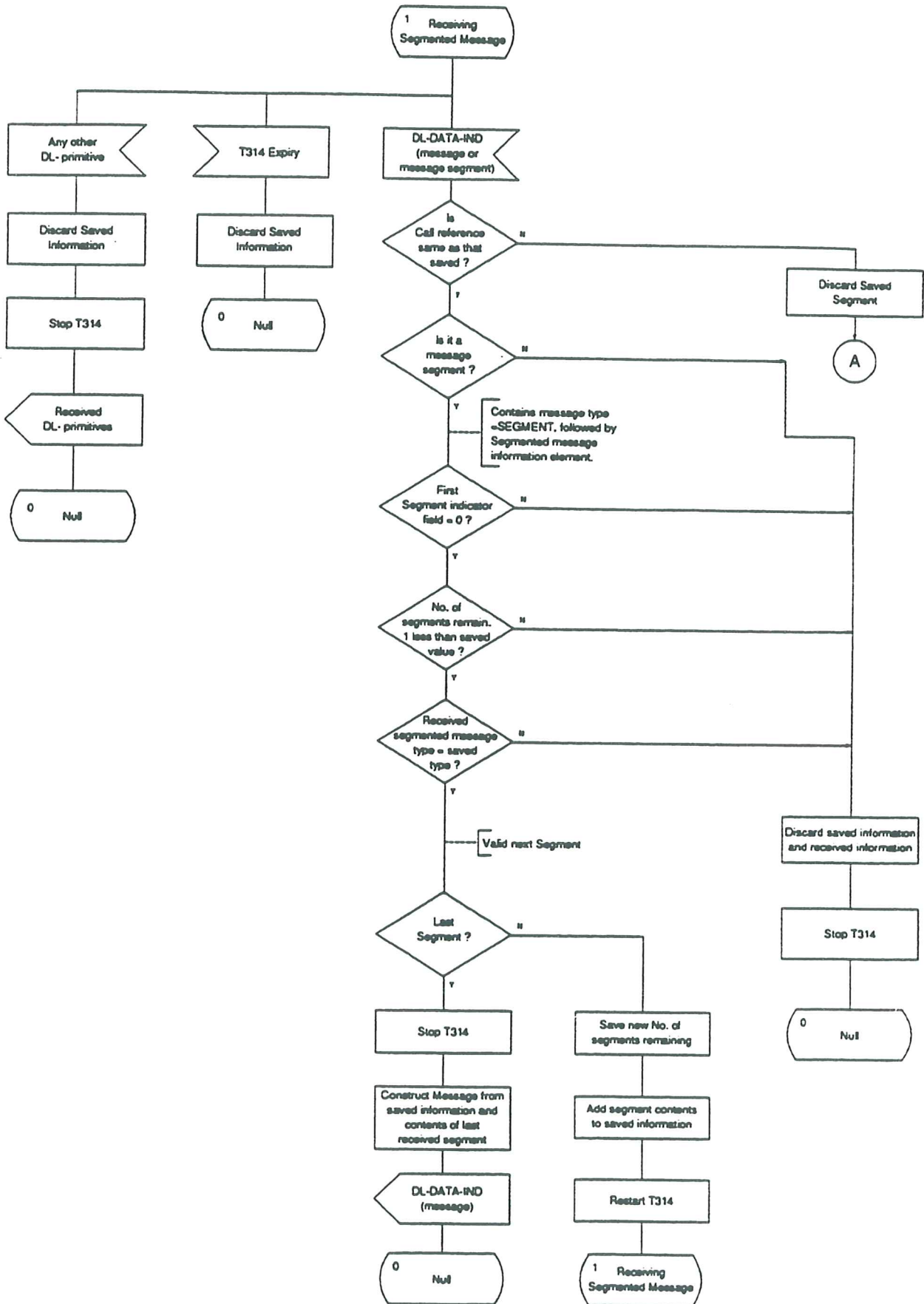

Figure 6 - Reassembly Process SDL (Part 2)

### 7.3 Handling of protocol error conditions

The procedures of 7.4, 8, 9 and 10 of this Specification are applicable only to those messages which pass the checks described in 7.3.1 to 7.3.7.

7.3.1 to 7.3.7 are listed in order of precedence.

#### 7.3.1 Protocol discriminator error

When a message is received with a protocol discriminator not in accordance with clause 12.2, that message shall be ignored. "Ignore" means to do nothing, as if the message had never been received.

#### 7.3.2 Message too short

When a message is received that is too short to contain a complete message type information element, that message shall be ignored.

#### 7.3.3 Call reference error

##### 7.3.3.1 Invalid Call reference format

If the Call reference information element octet 1, bits 5 to 8 are not set to '0000', then the message shall be ignored.

If octet 1, bits 1 to 4 of the call reference information element indicates a length greater than the maximum length supported by the receiving equipment, then the message shall be ignored.

If a message containing a Dummy call reference is received, except when used in the context of other standards which define its use, the message shall be ignored.

##### 7.3.3.2 Call reference procedural errors

Whenever any message except SETUP, STATUS, RELEASE or RELEASE COMPLETE is received specifying a call reference (other than the global call reference) which is not recognised as relating to an active call or to a call in progress, the receiving entity shall send a RELEASE COMPLETE message and remain in the null state. The RELEASE COMPLETE message shall contain the call reference of the received message and Cause no. 81, "invalid call reference".

Alternatively, the receiving entity may send a RELEASE message (in place of the RELEASE COMPLETE message) in this situation, but this is not the preferred option. The RELEASE message shall contain the call reference of the received message and Cause no. 81, "invalid call reference".

When a SETUP message is received specifying a call reference which is not recognised as relating to an active call or to a call in progress, and with a call reference flag incorrectly set to ONE, this message shall be ignored.

When a STATUS message is received specifying a call reference which is not recognised as relating to an active call or to a call in progress, the procedures of 7.4.2 shall apply.

When a RELEASE message is received specifying a call reference which is not recognised as relating to an active call or to a call in progress, the receiving entity shall send a RELEASE COMPLETE message. The RELEASE COMPLETE message shall contain the call reference of the received message and Cause no. 81, "invalid call reference".

When a RELEASE COMPLETE message is received specifying a call reference which is not recognised as relating to an active call or to a call in progress, no action shall be taken.

When a SETUP message is received specifying a call reference which is recognised as relating to an active call or to a call in progress, this SETUP message shall be ignored.

When any message except RESTART, RESTART ACKNOWLEDGE or STATUS is received specifying the global call reference, no action shall be taken on this message and a STATUS message specifying the global call reference with Cause no. 81 "invalid call reference value" shall be returned.

#### 7.3.4 Message type or message sequence errors

Whenever an unrecognised or unexpected message is received in any state other than the Null state, a STATUS message shall be returned with a Cause information element. The cause value used shall be no. 98 "message not compatible with call state or message type non-existing or not implemented". If the receiving entity can



distinguish between unimplemented (or non-existing) message types and implemented message types which are incompatible with the call state, then the cause used shall be:

- Cause no. 97 "message type non-existing or not implemented"; or
- Cause no. 101 "message type not compatible with the call state".

Alternatively, a STATUS ENQUIRY message may be sent requesting the Protocol Control state of the peer entity.

There are two exceptions where a STATUS or STATUS ENQUIRY message shall not be sent. The first exception is when the outgoing or incoming side receives an unexpected RELEASE message (e.g. if the DISCONNECT message was corrupted by undetected transmission errors). In this case the receiving entity shall: disconnect and release the B-channel; return RELEASE COMPLETE message to the originator; release the call reference; stop all timers; enter the Null state; and inform call control.

The second exception is when the outgoing or incoming side receives an unexpected RELEASE COMPLETE message. In this case, the receiving entity shall: disconnect and release the B-channel; release the call reference; stop all timers; enter the Null state; and inform call control.

### 7.3.5 General information element errors

#### 7.3.5.1 Duplicated information elements

If an information element is repeated in a message more times than is permitted for that particular message, only the contents of the occurrences of that information element up to the limit of repetitions shall be handled. All subsequent occurrences of the element shall be ignored.

#### 7.3.5.2 information elements exceeding maximum length

information elements with a length exceeding the maximum length (given in clause 12) shall be treated as information elements with content error.

#### 7.3.5.3 information elements out of sequence

If a variable length information element is received out of sequence (i.e. its code value is lower than that of the previous variable length information element) the receiving entity may ignore this information element and continue to process the message.

#### NOTE 2

*If the information element is mandatory and the receiver chooses to ignore the element, the error handling procedures of 7.3.6.1 will be followed. If the ignored information element is non-mandatory, the receiver will continue to process the message.*

Some implementations may choose to process all the information elements received, regardless of the order in which they are received.

### 7.3.6 Mandatory information element errors

#### 7.3.6.1 Mandatory information element missing

When a message other than SETUP, DISCONNECT, RELEASE, or RELEASE COMPLETE is received which has one or more mandatory information elements missing, no action shall be taken on the message and no state change shall occur. A STATUS message shall then be returned with Cause no. 96 "mandatory information element is missing".

When a SETUP message is received which has one or more mandatory information elements missing, a RELEASE COMPLETE message with Cause no. 96 "mandatory information element is missing" shall be returned.

When a DISCONNECT message is received with one or more mandatory information element missing, the actions taken shall be the same as if a DISCONNECT message with Cause no. 31 "normal, unspecified" was received (see 8.2), with the exception that the RELEASE message returned shall contain Cause no. 96 "mandatory information element missing".

When a RELEASE message is received as the first clearing message with one or more mandatory information element missing, the actions taken shall be the same as if a RELEASE message with Cause no.



31 "normal, unspecified" was received (see 8.2), except that if a RELEASE COMPLETE message is sent it shall contain Cause no. 96 "mandatory information element is missing".

When a RELEASE COMPLETE message is received as the first clearing message, with one or more mandatory information element missing, it shall be assumed that a RELEASE COMPLETE message was received with Cause no. 31 "normal, unspecified".

#### **7.3.6.2 Mandatory information element content error**

When a message other than SETUP, DISCONNECT, RELEASE, or RELEASE COMPLETE is received which has one or more mandatory information elements with invalid content, no action shall be taken on the message and no state change shall occur. A STATUS message shall then be returned with Cause no. 100 "invalid information element contents".

When a SETUP message is received which has one or more mandatory information elements with invalid content, a RELEASE COMPLETE message with Cause no. 100 "invalid information element contents" shall be returned.

When a DISCONNECT message is received with invalid content of the Cause information element, the actions taken shall be the same as if a DISCONNECT message with Cause no. 31 "normal, unspecified" was received (see 8.2.), with the exception that the RELEASE message returned shall contain Cause no. 100 "invalid information element contents".

When a RELEASE message is received with invalid content of the Cause information element, the actions taken shall be the same as if a RELEASE message with Cause no. 31 "normal, unspecified" was received (see 8.2), except that if a RELEASE COMPLETE message is sent, it shall contain Cause no. 100 "invalid information element contents".

When a RELEASE COMPLETE message is received with invalid content of the Cause information element, it shall be assumed that a RELEASE COMPLETE message was received with Cause no. 31 "normal, unspecified".

### **7.3.7 Non-mandatory information element errors**

#### **7.3.7.1 Non-mandatory information element not recognised**

When a message is received which has one or more non-mandatory information elements which are unrecognised, the receiving entity shall check whether they indicate "comprehension required" (refer to tables 24 and 37 for the information element identifiers reserved with this meaning). If any information element is encoded to indicate "comprehension required" then the procedures in 7.3.6.1 shall apply.

If all unrecognised information elements are not encoded to indicate "comprehension required", the following actions shall apply:

- The receiving entity shall take action on the message and on those information elements which are recognised and have valid content.
- When the received message is other than a DISCONNECT, RELEASE or RELEASE COMPLETE, a STATUS message may be returned containing one Cause information element. The Cause information element shall contain Cause no. 99 "information element non-existent", and the diagnostic field, if present, shall contain the unrecognised information element identifier for each information element that is unrecognised. The STATUS message shall indicate the call state which the receiving entity enters after processing the message in which the unrecognised information element was received.
- If a DISCONNECT message is received with one or more unrecognised information elements, the actions taken shall be the same as if a DISCONNECT message was received without these unrecognised information elements (see 8.2) with the exception that the RELEASE message returned shall contain Cause no. 99 "information element non-existent". This Cause information element may contain a diagnostic field which shall contain the information element identifier for each unrecognised information element.
- If a RELEASE message is received with one or more unrecognised information elements, the actions taken shall be the same as if a RELEASE message was received without these unrecognised information elements (see 8.2) with the exception that the RELEASE COMPLETE message returned shall contain



Cause no. 99 "information element non-existent". This Cause information element may contain a diagnostic field which shall contain the information element identifier for each unrecognised information element.

- If a RELEASE COMPLETE message is received with one or more unrecognised information elements, the actions taken shall be the same as if a RELEASE COMPLETE message without those unrecognised information elements was received.

#### 7.3.7.2 Non-mandatory information element content error

When a message other than DISCONNECT, RELEASE or RELEASE COMPLETE is received which has one or more non-mandatory information elements with invalid content, action shall be taken on the message and those information elements which are recognised and have valid content. A STATUS message may be returned containing a Cause information element with Cause no. 100 "invalid information element contents", and the diagnostic field, if present, shall contain the information element identifier for each information element with invalid content. The STATUS message shall indicate the call state which the receiving entity enters after processing the message in which the unrecognised information element was received.

If a DISCONNECT, RELEASE or RELEASE COMPLETE message is received which has one or more non-mandatory information elements with invalid content, normal call clearing procedures (defined in 8.2) shall apply.

#### 7.3.8 Data Link reset

Whenever a Protocol Control entity is informed of a spontaneous Data Link Layer reset by means of the DL-ESTABLISH-INDICATION primitive, the following procedures shall apply:

- For calls in the Overlap Sending state and the Overlap Receiving state, the entity shall initiate clearing by sending a DISCONNECT message with Cause no. 41 "Temporary Failure", and following the procedures of 8.2.
- For calls in the disestablishment phase (states 11, 12, and 19) no action shall be taken.
- Calls in the establishment phase (states 1, 3, 4, 6, 7, 8, and 9) and in the Active state shall be maintained. Optionally, a STATUS message may also be sent to report the current Protocol Control state to the peer entity or a STATUS ENQUIRY message may be sent to verify the Protocol Control state of the peer entity.

#### 7.3.9 Data Link failure

Whenever a Protocol Control entity is notified by its Data Link entity via the DL-RELEASE-INDICATION primitive that there is a Data Link Layer malfunction, the following procedure shall apply:

- Calls in the overlap sending or overlap receiving states shall be cleared internally. For any other call, timer T309 shall be started.

If timer T309 is already running, it shall not be restarted.

- the Protocol Control entity may request Data Link Layer re-establishment by sending a DL-ESTABLISH-REQUEST primitive.

When informed of Layer 2 re-establishment by means of the DL-ESTABLISH-CONFIRMATION primitive, the following procedure shall apply, for each call in progress:

- Timer T309 shall be stopped;
- Optionally, a STATUS message may also be sent to report the current Protocol Control state to the peer entity or a STATUS ENQUIRY message may be sent to verify the Protocol Control state of the peer entity. Cause no. 31 "normal, unspecified" is recommended to be used in the STATUS message.

If timer T309 expires prior to Data Link re-establishment, Protocol Control shall: release all resources; release the call reference; and enter the Null state. Call control shall be informed of the failure of the call.



## **7.4 Status and Status Enquiry Protocol Procedures**

### **7.4.1 Status Enquiry procedure**

Whenever a Protocol Control entity wants to check the correctness of a Protocol Control state at a peer Protocol Control entity, a STATUS ENQUIRY message may be sent requesting the Protocol Control state.

Upon sending the STATUS ENQUIRY message, timer T322 shall be started in anticipation of receiving a STATUS message. While timer T322 is running, only one outstanding request for Protocol Control state shall exist. Therefore if timer T322 is already running, it shall not be restarted. If a clearing message is received before timer T322 expires, timer T322 shall be stopped, and the call clearing shall continue.

Upon receipt of a STATUS ENQUIRY message, the receiving entity shall respond with a STATUS message, reporting the current Protocol Control state and containing Cause no. 30 "responding to STATUS ENQUIRY". Receipt of the STATUS ENQUIRY message shall not result in a state change.

The sending or receipt of the STATUS message in such a situation will not directly affect the Protocol Control state of either the sending or receiving entity. The side having received the STATUS message shall inspect the Cause information element. If the STATUS message contains any cause other than Cause no. 30 "responding to STATUS ENQUIRY", timer T322 shall continue to time for an explicit response to the STATUS ENQUIRY message.

If a STATUS message is received that contains Cause no. 30 "response to STATUS ENQUIRY" the timer T322 shall be stopped, and the "appropriate actions" shall be taken.

These "appropriate actions" are implementation dependent. However, the actions prescribed in 7.4.2 below shall apply.

If the sender's Protocol Control state changes after STATUS ENQUIRY has been sent, this shall be taken into account when checking for a compatible Protocol Control state in the received STATUS message.

If timer T322 expires, and no STATUS message was received, the STATUS ENQUIRY message may be transmitted a number of times until a response is received.

The number of times the STATUS ENQUIRY message may be retransmitted is a implementation dependent value. If the limit is exceeded, that call shall be cleared. The cause that should be used when clearing in this situation is Cause no. 41 "temporary failure". Call Control shall be notified of the failure of the call.

If T322 expires and a STATUS message, with a cause value other than no. 30 "response to STATUS ENQUIRY", was received the actions taken shall be an implementation option, which may be to process the received Protocol Control state in the same way as if the cause in the received STATUS message was no. 30 "response to STATUS ENQUIRY".

### **7.4.2 Receiving a STATUS message**

On receipt of a STATUS message containing a call reference value other than the Global Call Reference, the receiving entity shall check whether the Protocol Control state reported in the STATUS message is compatible with the state associated with that call reference internally. Table 1 indicates which Protocol Control states shall be considered compatible.

**Table 1 - Compatible Protocol Control states**

<b>Internal Protocol Control state associated with call reference</b>	<b>Reported Protocol Control state in STATUS message</b>
0 - Null	0 - Null
1 - Call Initiated	6 - Call Present
2 - Overlap Sending	25 - Overlap Receiving
3 - Outgoing Call Proceeding	9 - Incoming Call Proceeding
4 - Call Delivered	7 - Call Received
6 - Call Present	1 - Call Initiated
7 - Call Received	4 - Call Delivered
8 - Connect Request	10 - Active
9 - Incoming Call Proceeding	3 - Outgoing Call Proceeding
10 - Active	10 - Active 8 - Connect Request
11 - Disconnect Request	11 - Disconnect Request 12 - Disconnect Indication
12 - Disconnect Indication	11 - Disconnect Request
19 - Release Request	19 - Release Request
25 - Overlap Receiving	2 - Overlap Sending

**7.4.2.1 Receipt of a STATUS message reporting an incompatible Protocol Control state**

On receipt of a STATUS message reporting an incompatible Protocol Control state, the receiving entity shall either: clear the call by sending a RELEASE message with Cause no. 101 "message not compatible with call state"; or, take other actions which attempt to recover from a mismatch. These actions are an implementation decision.

The following rules shall, however, apply:

- If a STATUS message indicating any Protocol Control state except the Null state is received in the Null state, then a RELEASE COMPLETE message shall be sent.  
Alternatively, in this case a RELEASE message may be sent in place of the RELEASE COMPLETE message, but this is not the recommended option.
- If a STATUS message indicating any Protocol Control state except the Null state is received in the Release Request state, no action shall be taken.
- If a STATUS message, indicating the Null state, is received in any state except the Null state, the receiver shall release all resources and move into the Null state. Call Control shall be informed of the failure of the call.

When in the Null state, the receiver of a STATUS message indicating the Null state shall take no action other than to discard the message and shall remain in the Null state.

**7.4.2.2 Receipt of a STATUS message reporting a compatible Protocol Control state**

No action shall normally be taken on receipt of a STATUS message indicating a compatible Protocol Control state except where the STATUS message contains one of the following causes:

- no. 96 "mandatory information element is missing";
- no. 97 "message type non-existent or not implemented";



- no. 99 "information element non-existent or not implemented"; or,
- no. 100 "invalid information element contents".

In these cases, the actions to be taken are an implementation option. The receiving entity should attempt to analyse the contents of the received STATUS message considering the current stage of the call in order to determine whether or not the call can continue. If successful analysis and recovery are not possible, the call may be cleared as described in 8.2.

**7.4.2.3 Receiving a STATUS message containing the Global Call Reference**

On receipt of a STATUS message containing the Global Call Reference, the receiving entity shall check whether the reported layer management state is compatible with its own internal layer management state, according to table 2. Layer management shall be informed if the STATUS message reports an incompatible state in Restart or Restart Request states (1 or 2). Otherwise no action shall be taken.

**Table 2 - Compatible Layer Management states**

Internal layer management state associated with global call reference	Reported layer management state in STATUS message
0 - Null	0 - Null
1 - Restart Request	1 - Restart Request 2 - Restart
2 - Restart	1 - Restart Request

**8 Circuit-Switched Call Control Procedures**

The specification of the procedures for the control of Circuit-Switched Calls across the network is contained in four parts.

- The first part (8.1 and 8.3) specifies the procedures and message flows over a symmetrical interface between two peer PTNX's.  
Detailed specification and description language (SDL) diagrams for the procedures specified in these clauses are contained in 8.4.
- The second part (8.5) specifies how the procedures and messages either side of a transit PTNX are interrelated.  
Detailed specification and description language (SDL) diagrams for the procedures specified in this clause are contained in 8.6.
- The third part (8.7 and 8.8) specifies the requirements for call control at an End PTNX.
- The fourth part (8.9 and 8.10) specifies the requirements for call control at a Gateway PTNX.

**8.1 Call establishment**

**8.1.1 Call request**

Call establishment shall be initiated by the outgoing side transferring a SETUP message across the interface, and starting T303. The outgoing side shall select a channel (not known to be busy) for use by the call and indicate this in the Channel identification information element. If the outgoing side knows all appropriate channels controlled by the D-channel are in use, it shall not transfer a SETUP message across the interface.

If no response (as prescribed in 8.1.4) is received from the incoming side before timer T303 expires, the SETUP message shall optionally be retransmitted and timer T303 restarted.

If no response is received before timer T303 expires for a second time, the outgoing side shall send a RELEASE COMPLETE message to the incoming side. This message should contain Cause no. 102 "Recovery On Timer Expiry". Call Control shall be notified of the failure of the call.



The SETUP message shall always contain a call reference, selected according to the procedures given in 12.3. It shall also contain all the information required by the incoming side to process the call. The number digits within the Called party number information element may optionally be incomplete, thus requiring the use of Overlap Sending (see 8.1.3). The SETUP message may optionally contain the Sending complete information element in order to indicate that the number is complete.

Following the transmission of the SETUP message, the outgoing side shall enter the Call Initiated state. On receipt of the SETUP message the incoming side shall enter the Call Present state.

### 8.1.2 B-channel selection

In the SETUP message, the outgoing side shall indicate one of the following in the channel identification information element, in addition to the selected channel number:

- a) channel is indicated, no acceptable alternative; or,
- b) channel is indicated, any alternative is acceptable.

In both cases, if the indicated channel is available, the incoming side shall reserve it for the call.

In case b) if the indicated channel is not available, the incoming side shall reserve any available B-channel associated with the D-channel.

The selected B-channel shall be indicated in the first message returned by the incoming side in response to the SETUP message (i.e. a SETUP ACKNOWLEDGE or CALL PROCEEDING message). The receipt of an ALERTING or CONNECT message as the first response to SETUP shall not cause a protocol error, even though they would not normally be sent as the first responding message by a peer Protocol Control entity.

In case a) if the specified channel is not available, or, in case b) if no channel is available, a RELEASE COMPLETE message containing a Cause information element shall be sent by the incoming side as described in 8.2. Cause no. 44 "requested circuit/channel not available" shall be the cause sent in case a) and Cause no. 34 "no circuit/channel available" shall be the cause sent in case b). Call Control shall be informed of the failure of the call.

If the channel indicated in the CALL PROCEEDING or SETUP ACKNOWLEDGE message is unacceptable to the outgoing side, the call shall be cleared in accordance with 8.2. Cause no. 6 "channel unacceptable" should be the cause used here. Call Control shall be informed of the failure of the call.

### 8.1.3 Overlap sending

If the received SETUP message does not contain a Sending complete information element, and contains either:

- incomplete called number information; or,
- called number information which the incoming side cannot determine to be complete

The incoming side shall start timer T302, send a SETUP ACKNOWLEDGE message to the outgoing side, and enter the Overlap Receiving state.

When the SETUP ACKNOWLEDGE message is received, the outgoing side shall enter the Overlap Sending state, stop T303, and start timer T304.

After receiving the SETUP ACKNOWLEDGE message, the outgoing side shall send the remainder of the called party number digits (if any) in one or more INFORMATION messages.

The outgoing side shall restart timer T304 when each INFORMATION message is sent.

The INFORMATION message which completes the information sending may contain a "sending complete" information element. The incoming side shall restart timer T302 on the receipt of every INFORMATION message not containing a sending complete indication if it cannot determine that the called party number is complete.

If timer T304 expires the outgoing side shall initiate call clearing using the procedures in 8.2. The cause that should be used towards the calling user is Cause no. 28 "invalid number format"; towards the called user, the cause used should be Cause no. 102 "recovery on timer expiry". Call Control shall be informed of the failure of the call.

At the expiry of timer T302, the incoming side shall:

- if it determines that the call information is incomplete, initiate call clearing in accordance with 8.2 with Cause no. 28 "invalid number format";
- otherwise send a CALL PROCEEDING message and enter the Incoming Call Proceeding state.

#### 8.1.4 Call Proceeding

##### 8.1.4.1 Call proceeding, en-bloc sending

If en-bloc sending is used (i.e. the incoming side can determine it has received sufficient information in the SETUP message from the outgoing side to establish the call) the incoming side shall send a CALL PROCEEDING message to the outgoing side to acknowledge the SETUP message and to indicate that the call is being processed. Upon receipt of the CALL PROCEEDING message, the outgoing side shall enter the Outgoing Call Proceeding state, stop timer T303 and, if applicable start T310. After sending the CALL PROCEEDING message, the incoming side shall enter the Incoming Call Proceeding state.

If, following the receipt of a SETUP message, the incoming side determines that for some reason the call cannot be supported, then the incoming side shall initiate call clearing as defined in 8.2. Examples of some of the causes that may be used are given in 8.1.8.

##### 8.1.4.2 Call proceeding, overlap sending

Following the occurrence of one of these conditions:

- the receipt by the incoming side of a sending complete indication; or,
- analysis by the incoming side that all call information necessary to effect call establishment has been received;

and if the incoming side can determine that access to the requested service is available, the incoming side shall: send a CALL PROCEEDING message to the outgoing side; stop timer T302; and enter the Incoming Call Proceeding state.

If, following the receipt of a SETUP message or during Overlap Sending the incoming side determines that for some reason the call cannot be supported, the incoming side shall initiate call clearing as defined in 8.2. Examples of some of the causes that may be used are given in 8.1.8.

#### NOTE 3

*The CALL PROCEEDING message is sent to indicate that the requested call establishment has been initiated, and no more call establishment information will be accepted.*

When the outgoing side receives the CALL PROCEEDING message it shall enter the Outgoing Call Proceeding state, stop timer T304 and, if applicable start timer T310.

Upon receiving an indication that the called party is alerting or that the call has been answered, the incoming side shall stop T302 and send an ALERTING or CONNECT message, respectively, to the outgoing side. When the outgoing side receives a CONNECT or an ALERTING message, timer T304 shall be stopped.

Any INFORMATION message received by the incoming side after having sent a CALL PROCEEDING, ALERTING or CONNECT message to the outgoing side shall be discarded.

##### 8.1.4.3 Expiry Of Timer T310

On expiry of T310 (i.e. if the outgoing side does not receive an ALERTING, CONNECT, DISCONNECT or PROGRESS message [containing CCITT progress description no. 1 or no. 8]) the outgoing side shall initiate clearing procedures as described in 8.2. The clearing cause sent to the incoming side should be Cause no. 102 "Recovery On Timer Expiry". Call Control shall be notified of the failure of the call.

#### 8.1.5 Call confirmation indication

Upon receiving an indication that the called party is alerting, the incoming side shall send an ALERTING message to the outgoing side and enter the Call Received state. The ALERTING message shall only be sent after a SETUP ACKNOWLEDGE or a CALL PROCEEDING message has been sent across the interface.



When the outgoing side receives the ALERTING message it shall enter the Call Delivered state, stop T310, if running and optionally start T301.

Any INFORMATION message received by the incoming side after having sent a CALL PROCEEDING, ALERTING or CONNECT message to the outgoing side shall be discarded.

If T301 expires prior to the receipt of a CONNECT message then the outgoing side shall clear the call in accordance with the procedures contained in 8.2. The clearing cause used should be Cause no. 19 "No answer from user (user alerted)".

#### **8.1.6 Call connected**

Upon receiving an indication that the call has been answered, the incoming side shall send a CONNECT message to the outgoing side and either: start timer T313 and enter the Connect Request state; or enter the Active state. The CONNECT message shall only be sent after a SETUP ACKNOWLEDGE or a CALL PROCEEDING message has been sent across the interface.

The CONNECT message indicates to the outgoing side that a connection has been established through the network and stops a possible local indication of alerting.

On receipt of the CONNECT message, the outgoing side shall: stop T310, T301 or T304 (if running), send a CONNECT ACKNOWLEDGE message to the incoming side and enter the Active state.

If, on receipt of the CONNECT ACKNOWLEDGE message the incoming side is in the Connect Request state, it shall enter the Active state and cancel timer T313. If the incoming side is in the Active state when a CONNECT ACKNOWLEDGE message is received, this message shall be ignored.

Any INFORMATION message received by the incoming side after having sent a CALL PROCEEDING, ALERTING or CONNECT message to the outgoing side shall be discarded.

If T313 expires prior to the receipt of a CONNECT ACKNOWLEDGE message, then the incoming side shall initiate call clearing procedures by sending a DISCONNECT message to the outgoing side, as described in 8.2. The cause value used in this situation should be no. 102 "recovery on timer expiry".

#### **8.1.7 Use of the PROGRESS message**

##### **8.1.7.1 During Call Establishment**

During call establishment, the call may leave the PTN environment (e.g. because of interworking with another network). When this situation occurs, a Progress indicator information element containing the appropriate progress description value shall be sent over the PTN in the direction of the calling user. The progress indicator information element may be repeated, if necessary, to indicate more than one condition.

Where this indication cannot be sent in a call control message (e.g. ALERTING) it shall be sent in a PROGRESS message. On receipt of a PROGRESS message, no state change shall occur, but timer T310 (if running) shall be stopped when CCITT progress description no. 1 "call is not end to end ISDN, further progress information may be available in-band", no. 2 "destination address is non-ISDN" or no. 8 "in-band information or appropriate pattern now available" is received.

##### **8.1.7.2 During Call Failure**

If an in-band tone or announcement is to be applied to indicate to the calling user failure of a call which has not yet reached the active state, the incoming side shall send a PROGRESS message to ensure that the B-channel is through connected from the provider of the tone to the calling user. If an in-band tone or announcement is applied to indicate to a user failure of a call that has reached the Active state, the in-band tone or announcement may be applied without sending a PROGRESS message, as the B-channel would already be through connected in both directions.

If used, the PROGRESS message shall contain CCITT progress description no. 8 "in-band information or appropriate pattern now available" and a Cause information element indicating the failure cause value.

#### *NOTE 4*

*Normal call clearing will follow later, initiated either by the user receiving the in-band tone or announcement (potentially during the tone or announcement) or by the entity providing the tone or announcement if no clearing indication is received by the user within an appropriate time.*



### 8.1.8 Failure of Call Establishment

In the Call Present, Overlap Receiving, Incoming Call Proceeding or Call Received states, the incoming side may initiate clearing as described in 8.2 with cause. Examples of some of the causes that may be used to clear the call, when the incoming side is in the Call Present, Overlap Receiving, or Incoming Call Proceeding state are as follows:

- no. 1 "unassigned (unallocated) number";
- no. 3 "no route to destination";
- no. 17 "user busy";
- no. 18 "no user responding";
- no. 22 "number changed";
- no. 28 "invalid number format";
- no. 34 "no circuit channel available";
- no. 44 "requested circuit channel not available";
- no. 58 "bearer capability not presently available";
- no. 65 "bearer capability not implemented".

Examples of two of the causes that may be used to clear the call when the incoming side is in the Call Received state are as follows:

- no. 19 "no answer from user (user alerted)";
- no. 21 "call rejected by user".

## 8.2 Call clearing

### 8.2.1 Terminology

The following terms are used in this Standard in the description of clearing procedures:

- A channel is "connected" when the channel is part of an PTN connection established according to this Standard.
- A channel is "disconnected" when the channel is no longer part of an PTN connection, but is not yet available for use in a new connection.
- A channel is "released" when the channel is not part of an PTN connection and is available for use in a new connection.

Similarly, a call reference that is "released" is available for reuse.

### 8.2.2 Exception conditions

Apart from the exceptions listed below, call clearing shall be initiated when the outgoing side or the incoming side sends a DISCONNECT message and follows the procedures defined in 8.2.3. The exceptions to the above rule are as follows:

- The rejection of a SETUP message by the incoming side when no responding message has previously been sent (e.g. because of the unavailability of a suitable B-channel) shall be accomplished by returning a RELEASE COMPLETE message, releasing the call reference, and entering the null state.
- Unsuccessful termination of the B-channel selection procedure by the side offering the call shall be accomplished by sending a RELEASE message to the other side. The RELEASE message shall contain Cause no. 6 "channel unacceptable".
- During call establishment, call clearing may be initiated towards the called user before a B-channel has been agreed between the outgoing and incoming sides. In this case, clearing shall be accomplished by sending a RELEASE message containing a Cause information element to the incoming side. The cause value used shall be appropriate to the clearing circumstances. For example, if the failure was due to the

calling user clearing before the call reaches its destination node, the cause value would be the value supplied by the calling user, e.g. no. 31 "normal, unspecified".

### 8.2.3 Clearing

Apart from the exceptions identified in 7.3 and 8.2.2, the clearing procedures are symmetrical and may be initiated by either the outgoing or the incoming side. In the interest of clarity, the following procedures describe only the case where the outgoing side initiates clearing.

On sending or receiving any call clearing message, any protocol timer other than T305 or T308 shall be terminated.

The outgoing side shall initiate clearing by: sending a DISCONNECT message; starting timer T305; disconnecting the B-channel; and entering the Disconnect Request state. Following the receipt of the DISCONNECT message, the incoming side shall consider the call to be in the Disconnect Indication state.

On receipt of the DISCONNECT message the incoming side shall: disconnect the B-channel used in the call; send a RELEASE message to the outgoing side; start timer T308; and enter the Release Request state.

On receipt of the RELEASE message the outgoing side shall: cancel timer T305; release the B-channel; send a RELEASE COMPLETE message; release the call reference; and return to the Null state.

On receipt of a RELEASE COMPLETE message from the outgoing side, the incoming side shall: stop timer T308; release both the B-channel and the call reference; and return to the Null state.

If the outgoing side does not receive a RELEASE message in response to the DISCONNECT message before timer T305 expires, it shall send a RELEASE message to the incoming side with the cause number originally contained in the DISCONNECT message, start timer T308 and enter the Release Request state.

If in the Release Request state, a RELEASE COMPLETE message is not received before the first expiry of timer T308, the RELEASE message shall be retransmitted and timer T308 shall be restarted. If no RELEASE COMPLETE message is received before timer T308 expires a second time, the side that expected the message shall; place the B-channel in a maintenance condition; release the call reference; and return to the Null state.

### 8.2.4 Clear Collision

Clear Collision occurs when both the incoming and outgoing sides simultaneously transfer DISCONNECT messages specifying the same call reference value. When either side receives a DISCONNECT message whilst in the Disconnect Request state, the side shall stop timer T305; disconnect the B-channel (if not already disconnected); send a RELEASE message to the other side; start timer T308 and enter the Release Request state.

Clear collision can also occur when both sides simultaneously transfer RELEASE messages related to the same call reference value. The receiving side shall (on receiving such a RELEASE message in the Release request state) stop T308; release the call reference and B-channel; and enter the null state (without sending a RELEASE COMPLETE message).

### 8.3 Call Collisions

In symmetric arrangements, call collisions can occur when both sides simultaneously transfer a SETUP message indicating the same channel. One side shall be designated side "A" and the other side "B" at the time the network is provisioned. Each side shall have knowledge of whether it has been designated "A" or "B". In the three possible scenarios where the same channel has been indicated by both sides, the following procedure shall apply:

- "A" side preferred, "B" side preferred: The "A" side shall be awarded the channel, and an alternative channel (if a free channel exists) shall be indicated in the first response to the SETUP message sent from side "B".
- "A" side exclusive, "B" side exclusive: The "A" side shall be awarded the channel, and the call establishment attempt at side "B" shall be cleared with a RELEASE COMPLETE message. The cause used shall be Cause no. 44 "requested circuit/channel not available".
- "A" side exclusive, "B" side preferred; or "A" side preferred, "B" side exclusive: The side with an exclusive channel indicator in a SETUP message shall be awarded the channel and an alternative channel (assuming



a free channel exists) shall be indicated in the first response to the side that used a preferred indicator in the SETUP message.

In order to minimise the chances of call collisions, it is recommended that side "A" assign the lowest available channel number and that side "B" assign the highest available channel number.

**8.4 Protocol Control SDL Diagram (informative)**

Figure 8 in this clause contains an SDL diagram which provides an example of the Protocol Control procedures as described in 8.1 to 8.3. The procedures illustrated are not intended to be exhaustive, and several potential situations that may occur have been omitted from the SDL (e.g. some error conditions and procedures such as the status enquiry procedure).

Figure 7 provides the key to the symbols used in figure 8. The primitive symbols contain primitives which come from a number of sources, each identified by a prefix to the primitive name as indicated in table 3.

**Table 3 - Key to primitive types in Protocol Control SDL Diagram**

Prefix	Primitive from/to:
CC_	Call Control
GCC_	Global Call Control
DL_	Data Link Layer
Event_	An entity which provides Protocol Control with notification of protocol related events other than receipt of incoming messages or primitives from Call Control, Global Call Control or the Data Link Layer

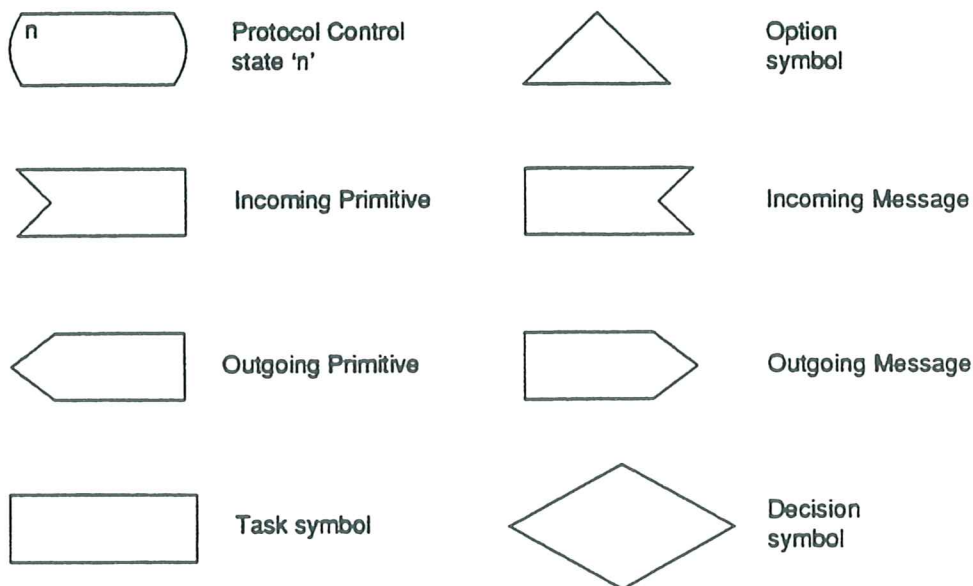

**Figure 7 - Key to Symbols used in the Protocol Control SDL diagram**



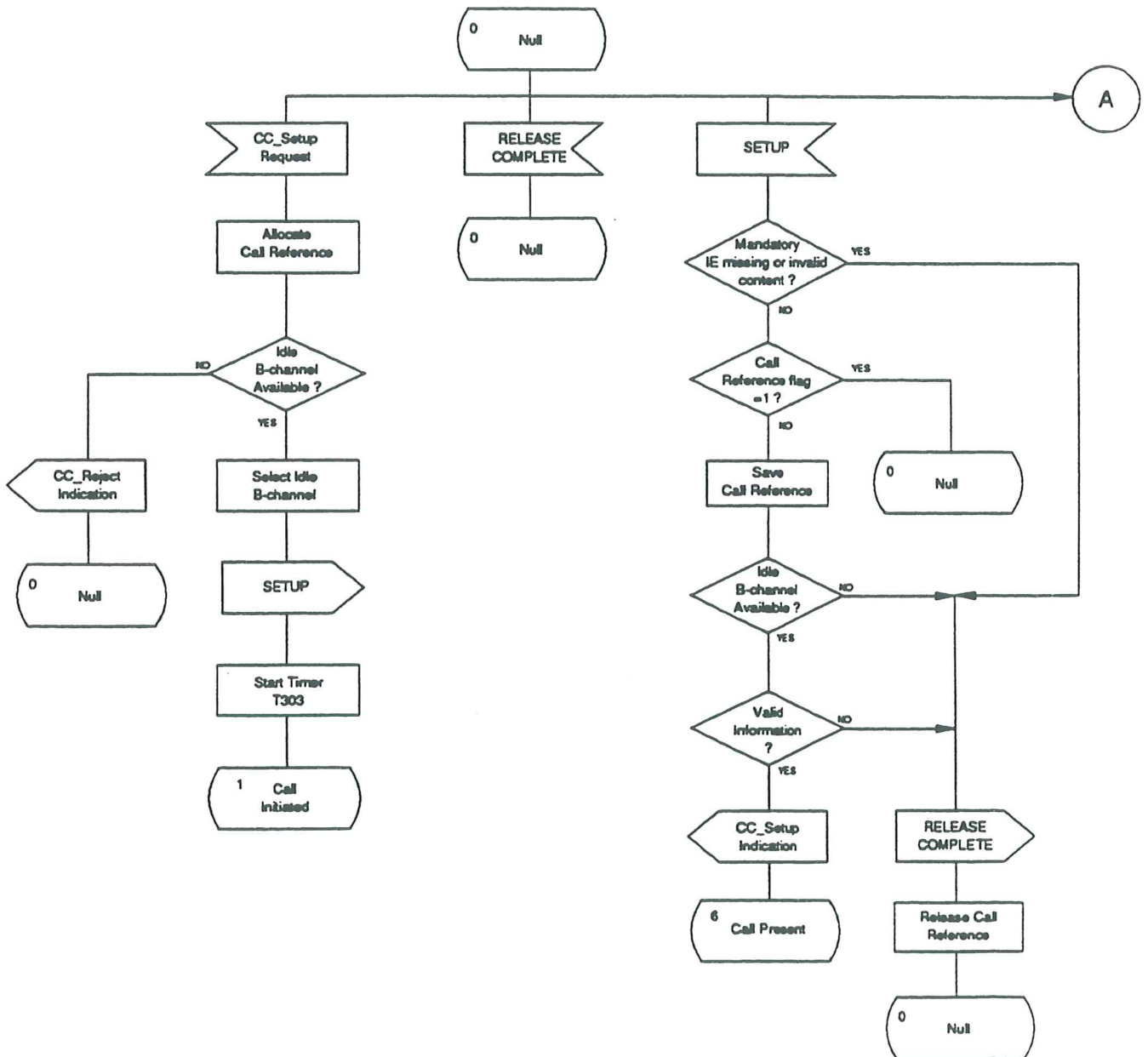

Figure 8 - Protocol Control SDL Diagram (Part 1)

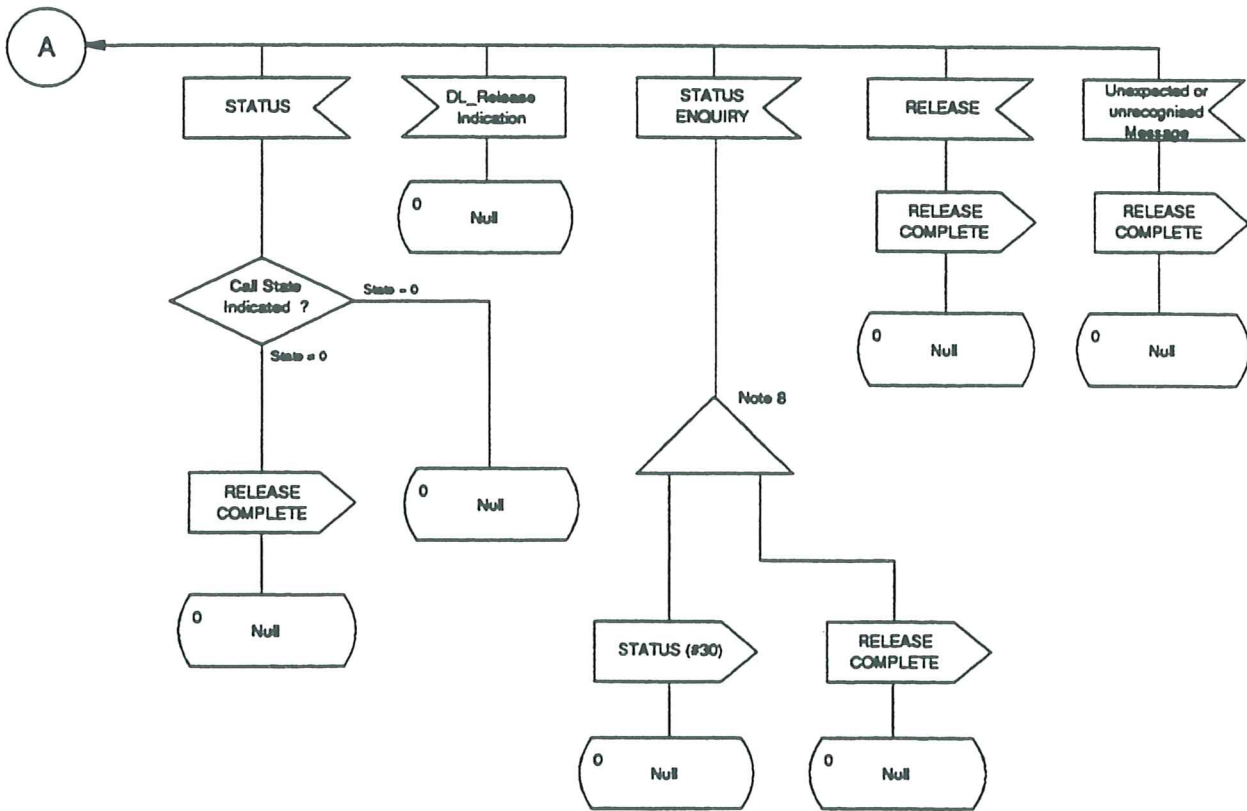

Figure 8 - Protocol Control SDL (Part 2)

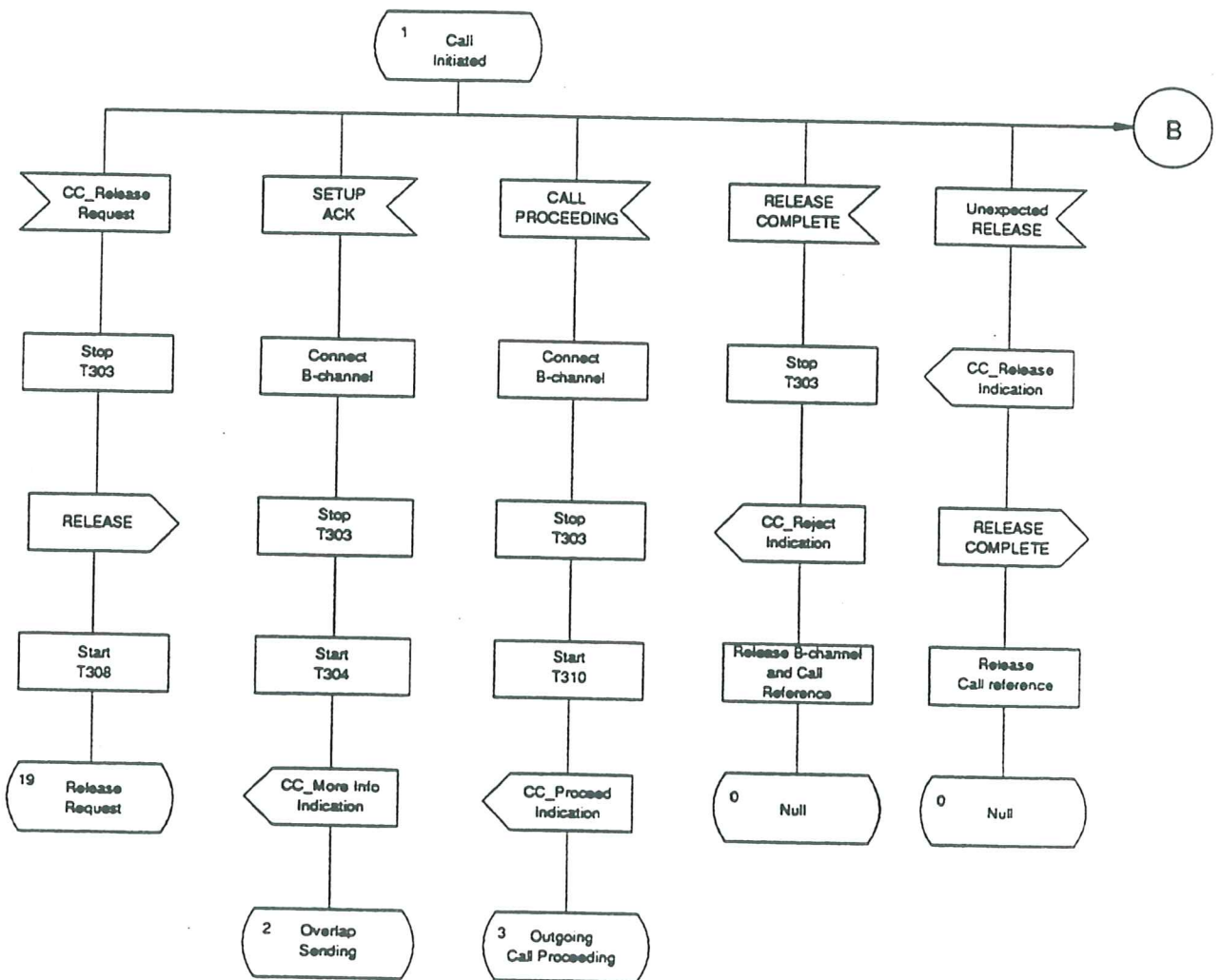

Figure 8 - Protocol Control SDL (Part 3)



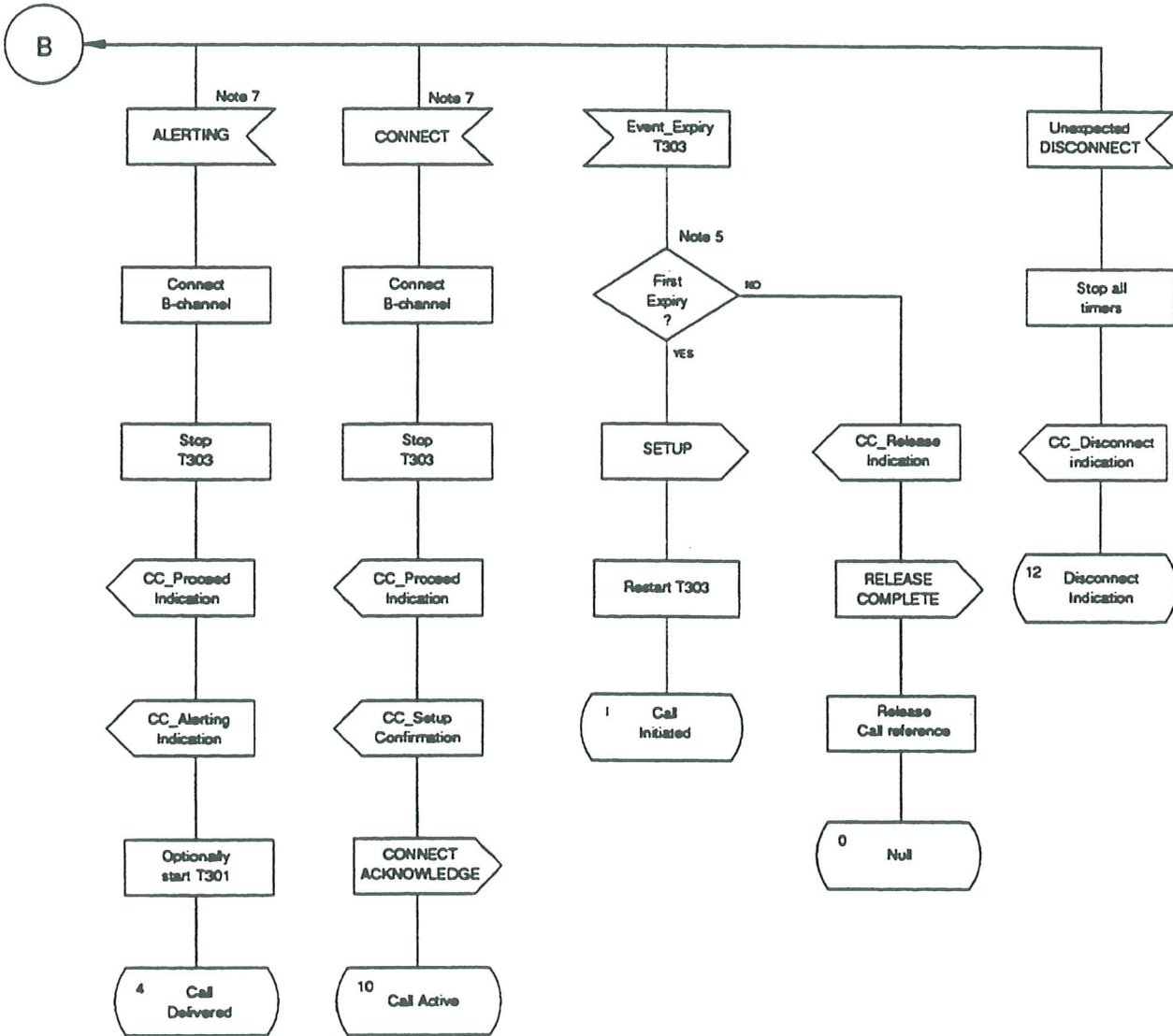

Figure 8 - Protocol Control SDL (Part 4)

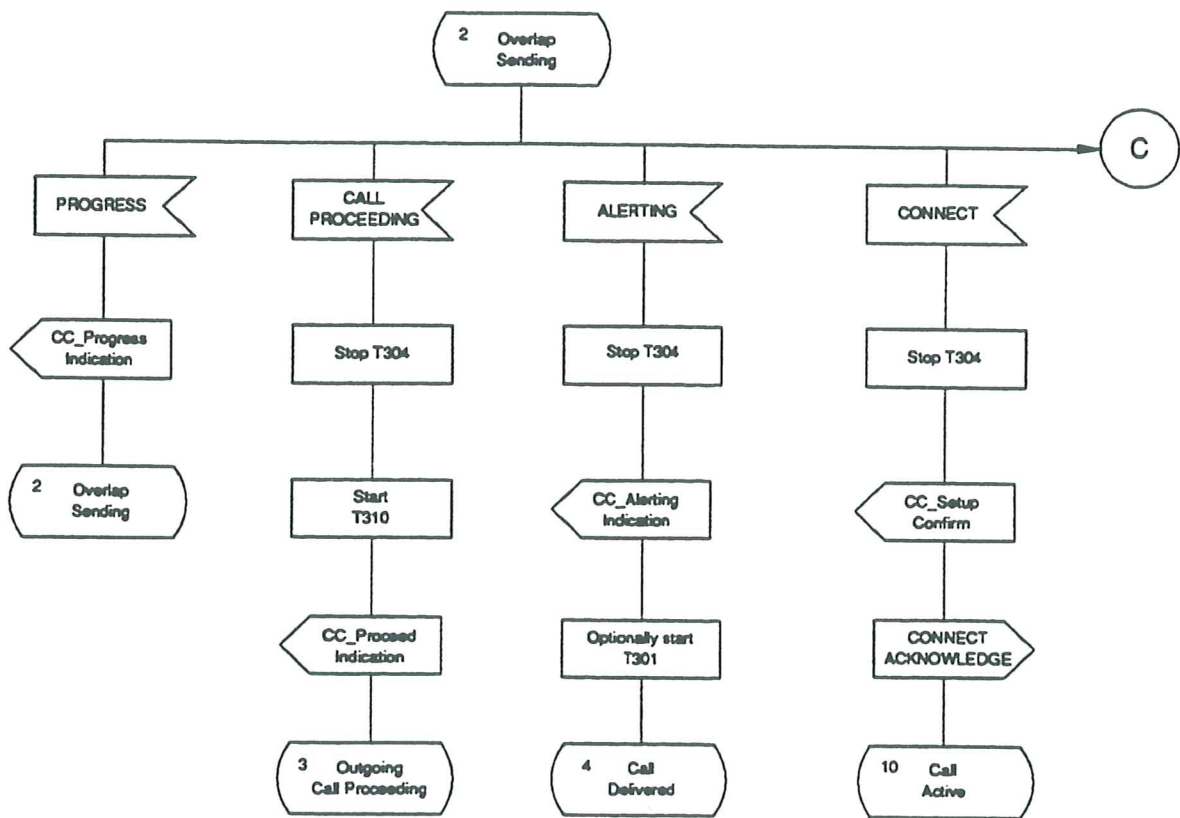

Figure 8 - Protocol Control SDL (Part 5)

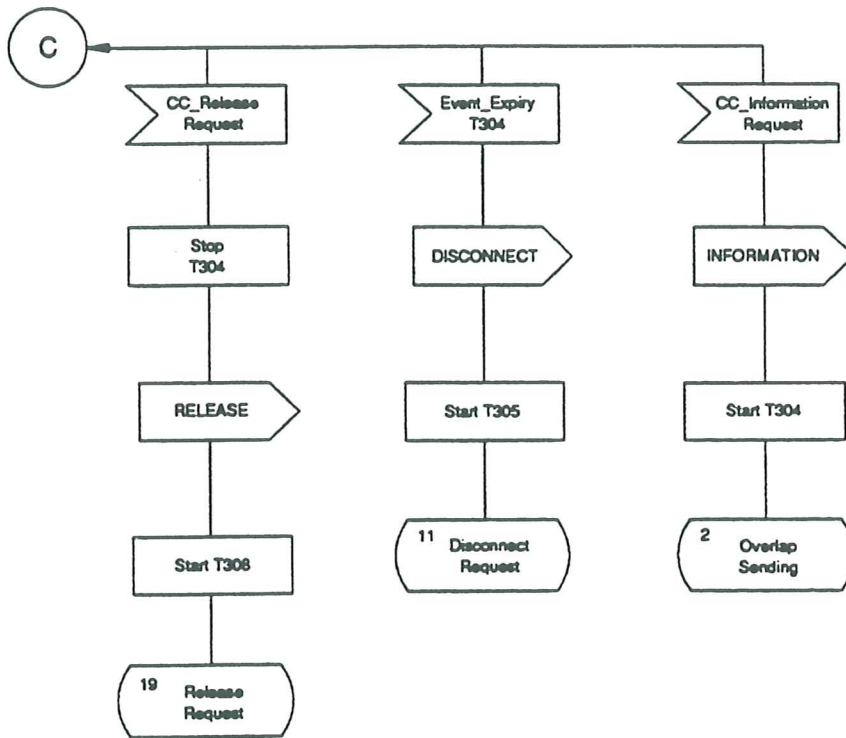

Figure 8 - Protocol Control SDL (Part 6)



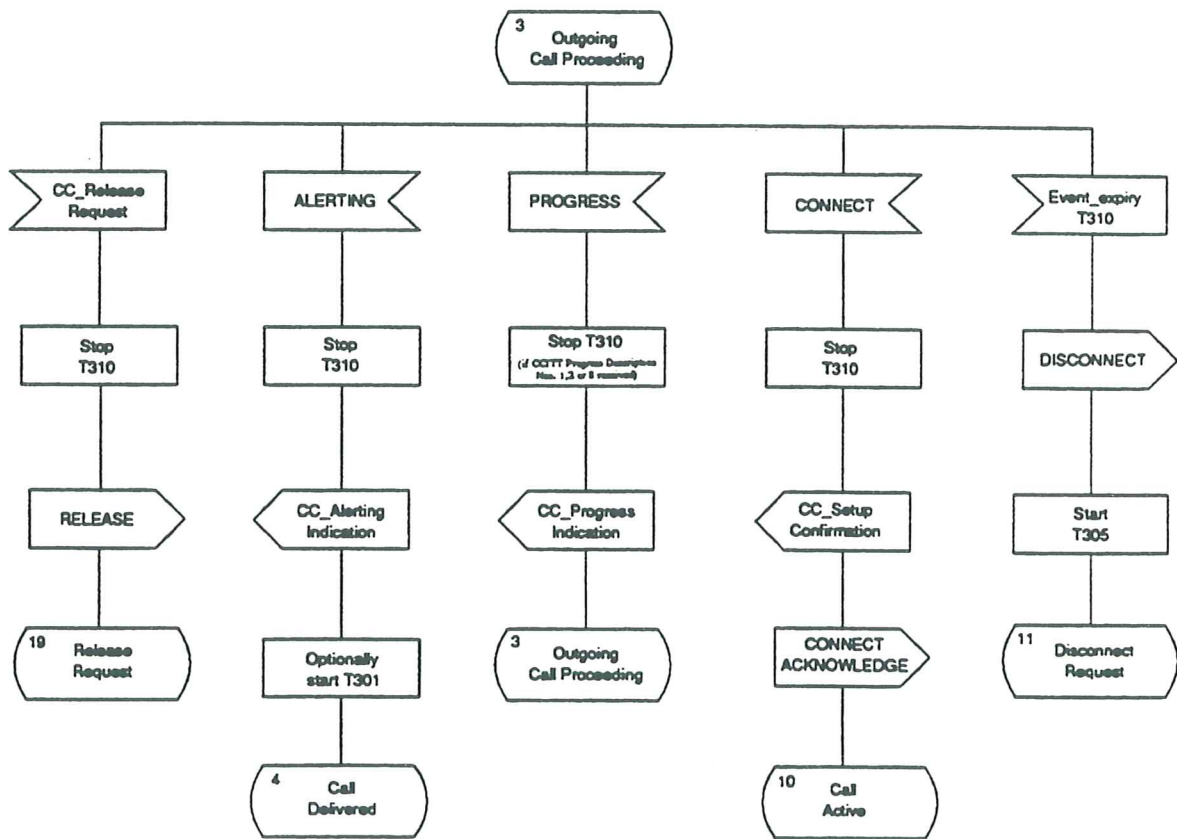

Figure 8 - Protocol Control SDL (Part 7)

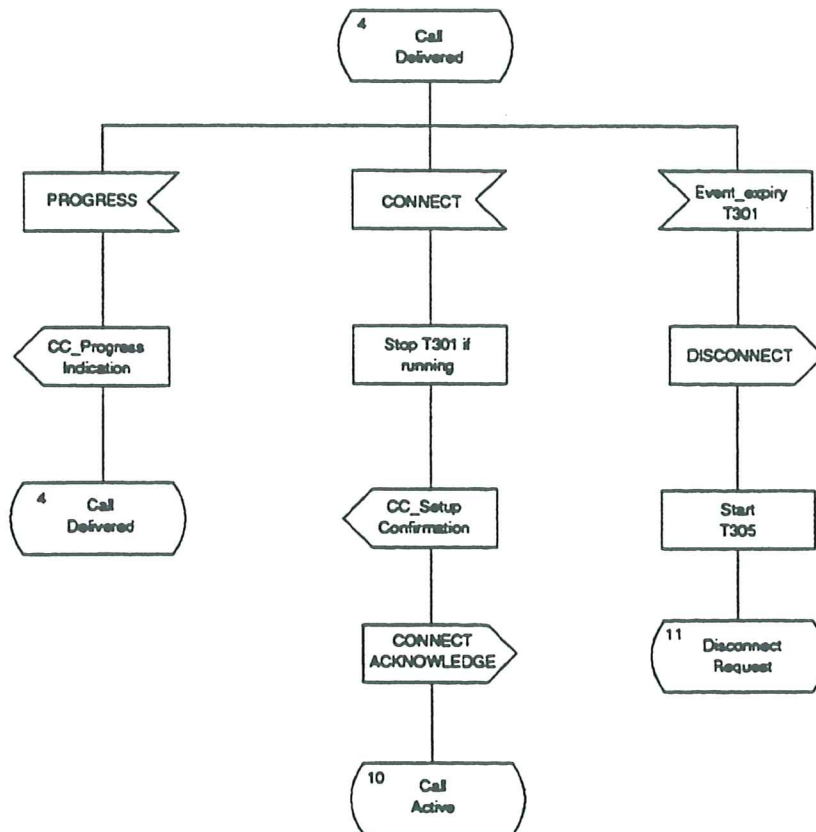

Figure 8 - Protocol Control SDL (Part 8)

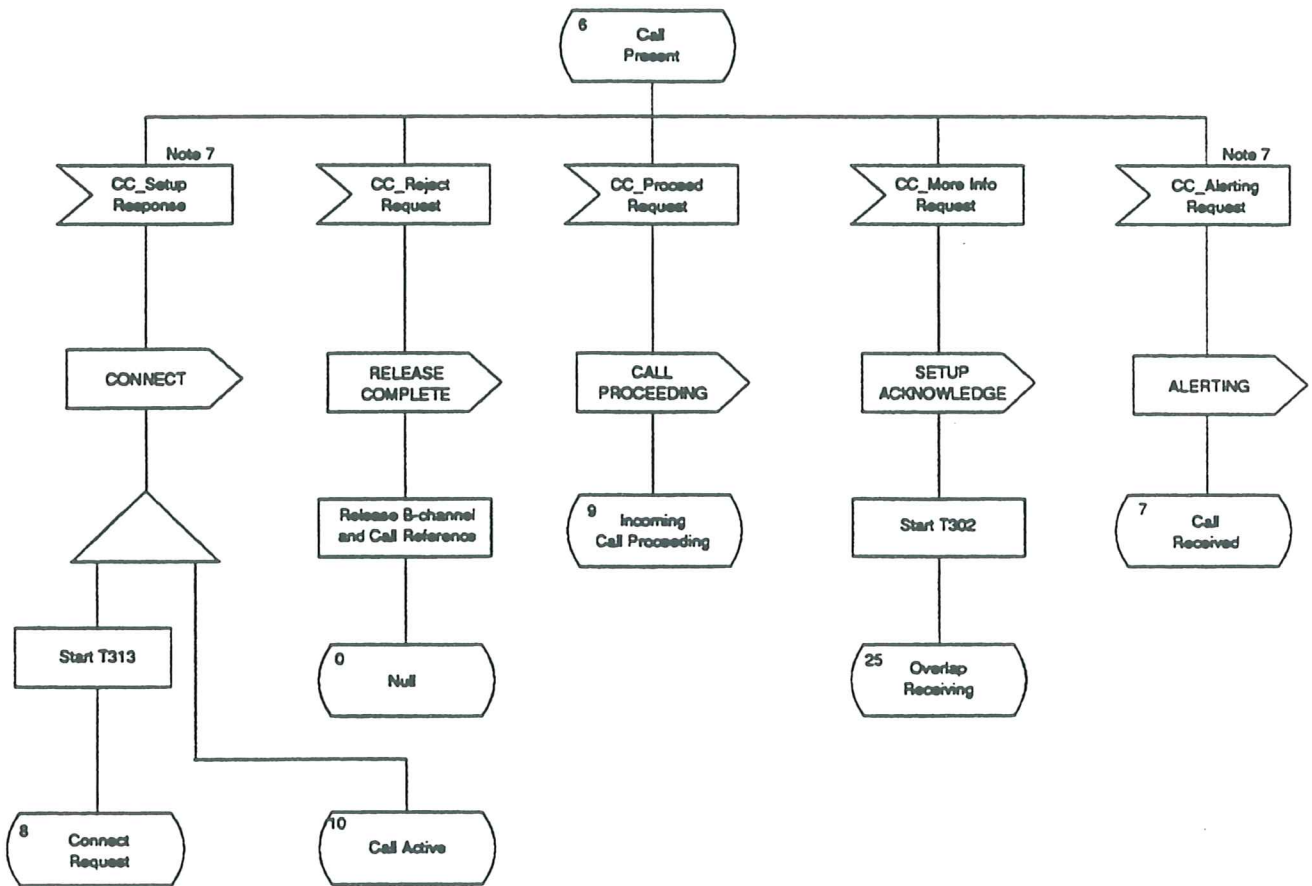

Figure 8 - Protocol Control SDL (Part 9)



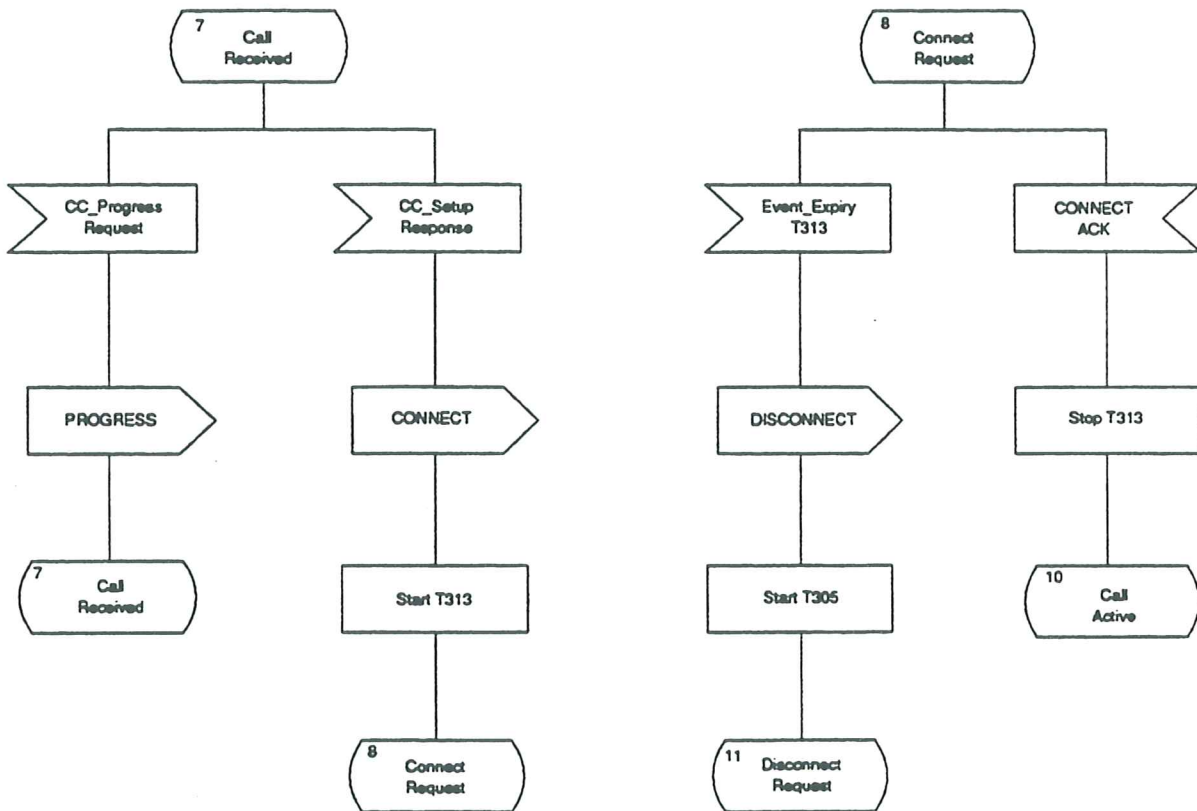

Figure 8 - Protocol Control SDL (Part 10)

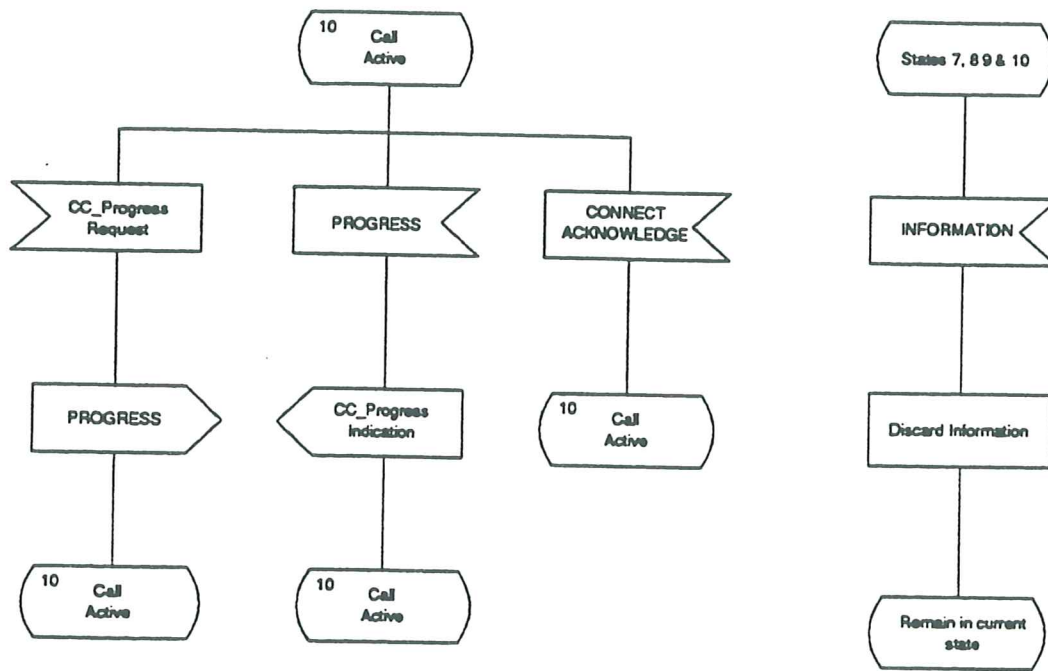

Figure 8 - Protocol Control SDL (Part 11)

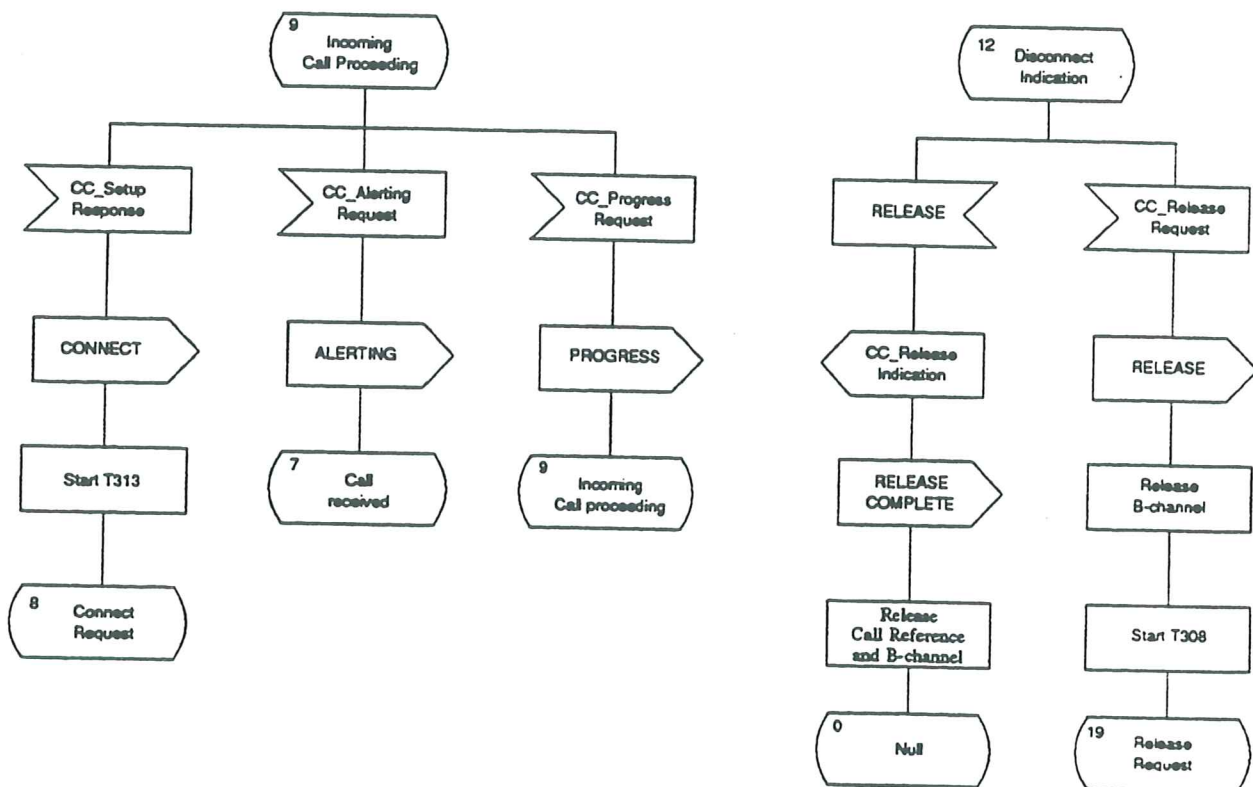

Figure 8 - Protocol Control SDL (Part 12)



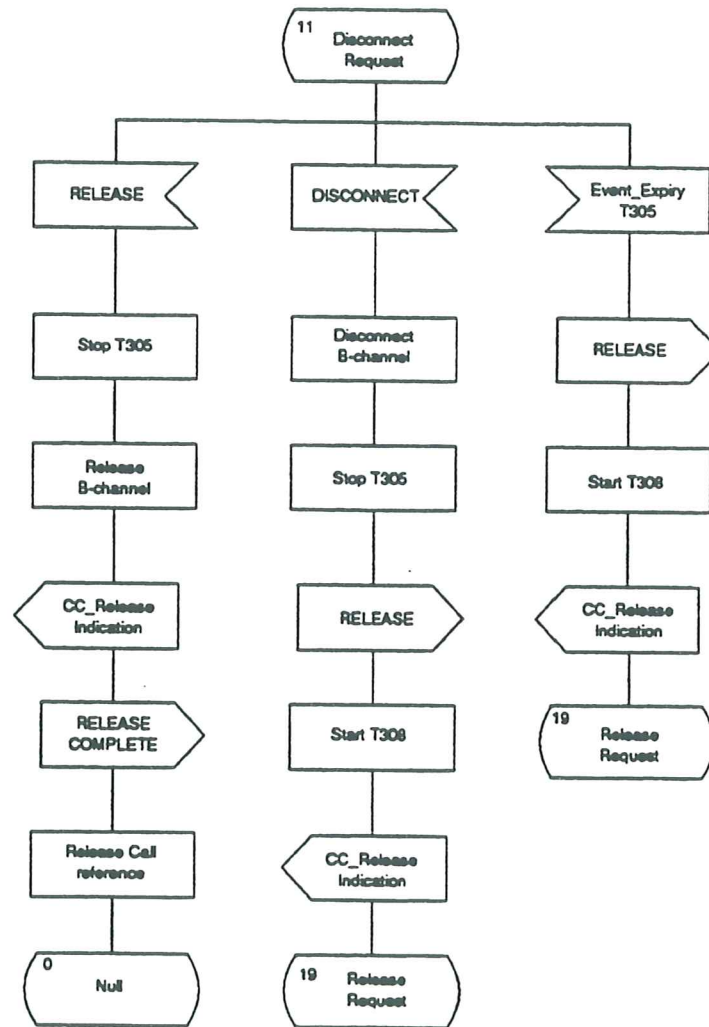

Figure 8 - Protocol Control SDL (Part 13)

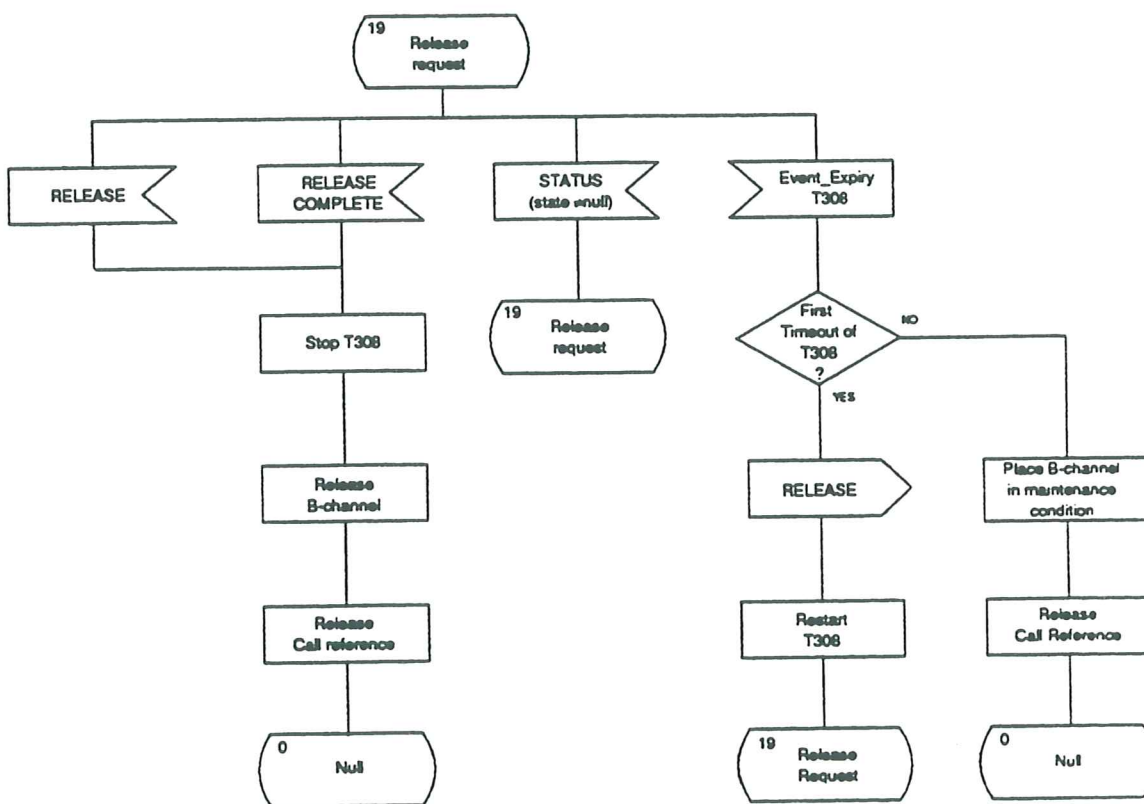

Figure 8 - Protocol Control SDL (Part 14)

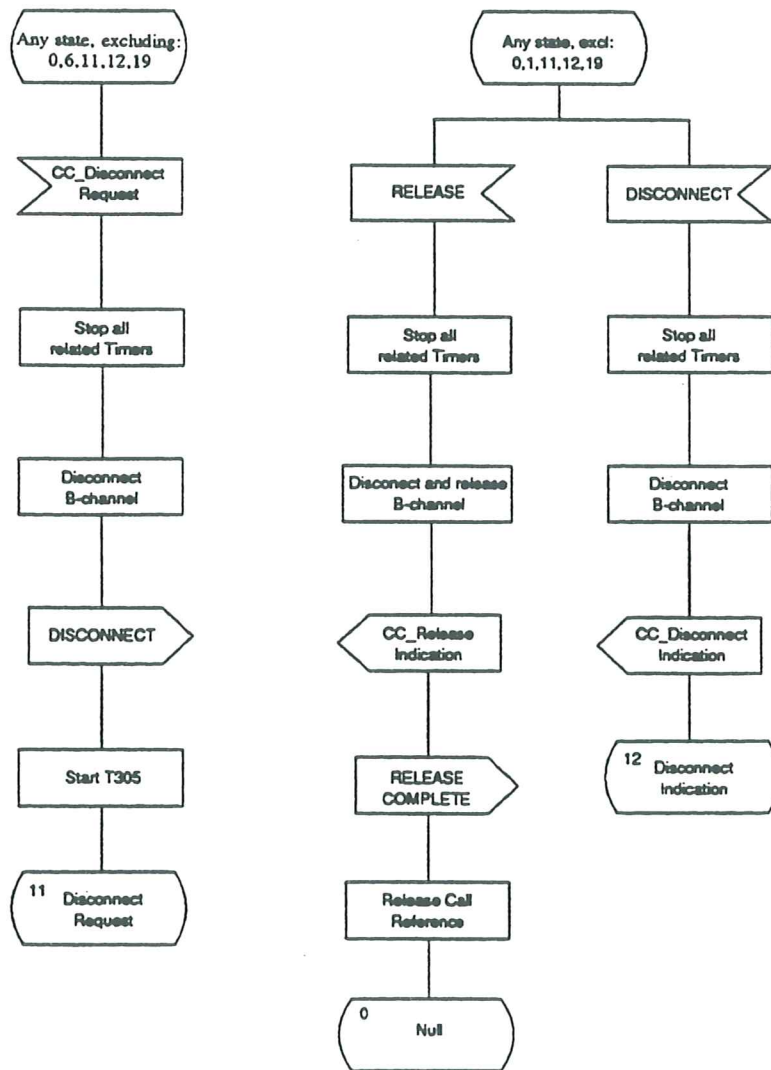

Figure 8 - Protocol Control SDL (Part 15)



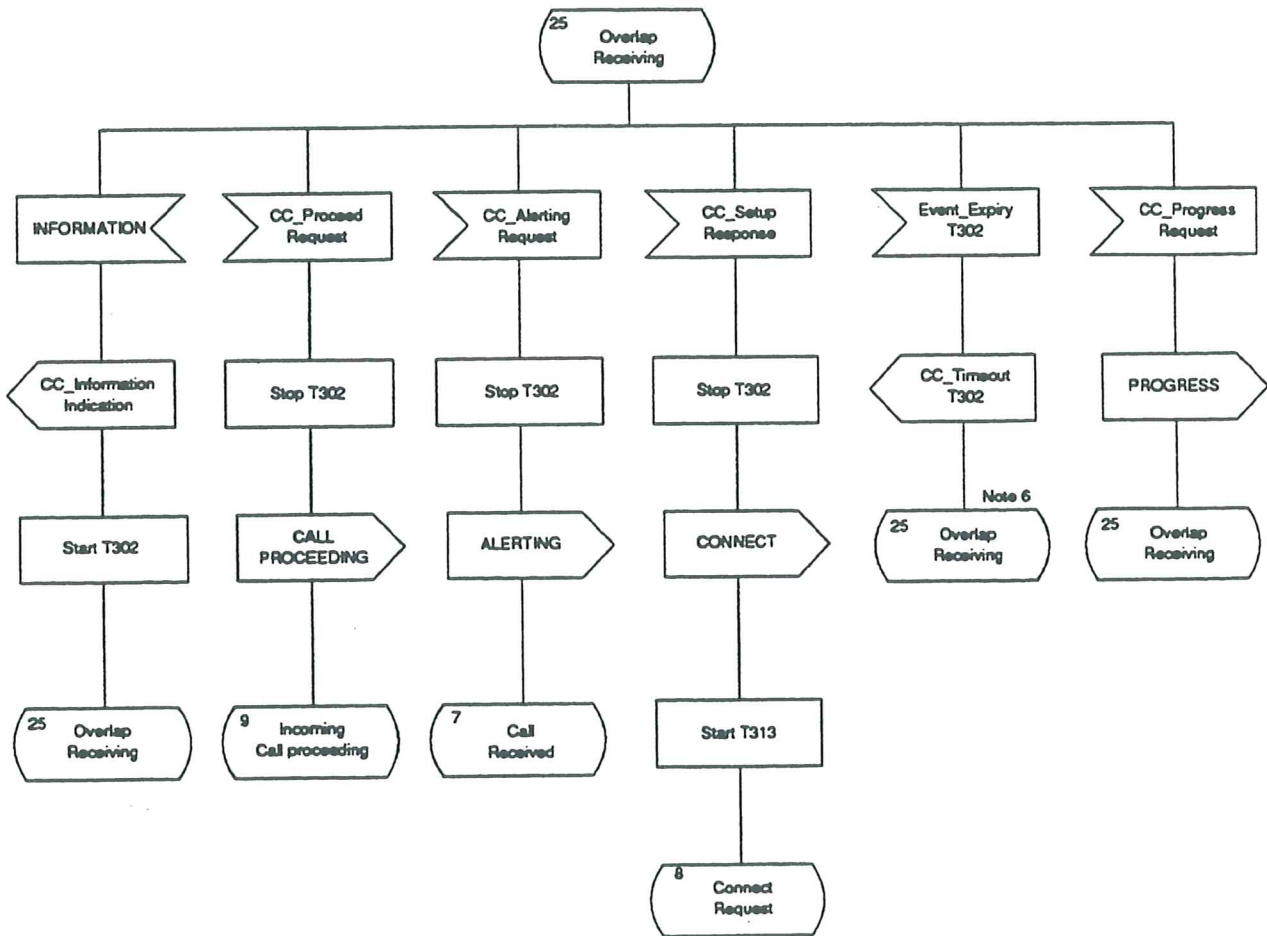

Figure 8 - Protocol Control SDL (Part 16)

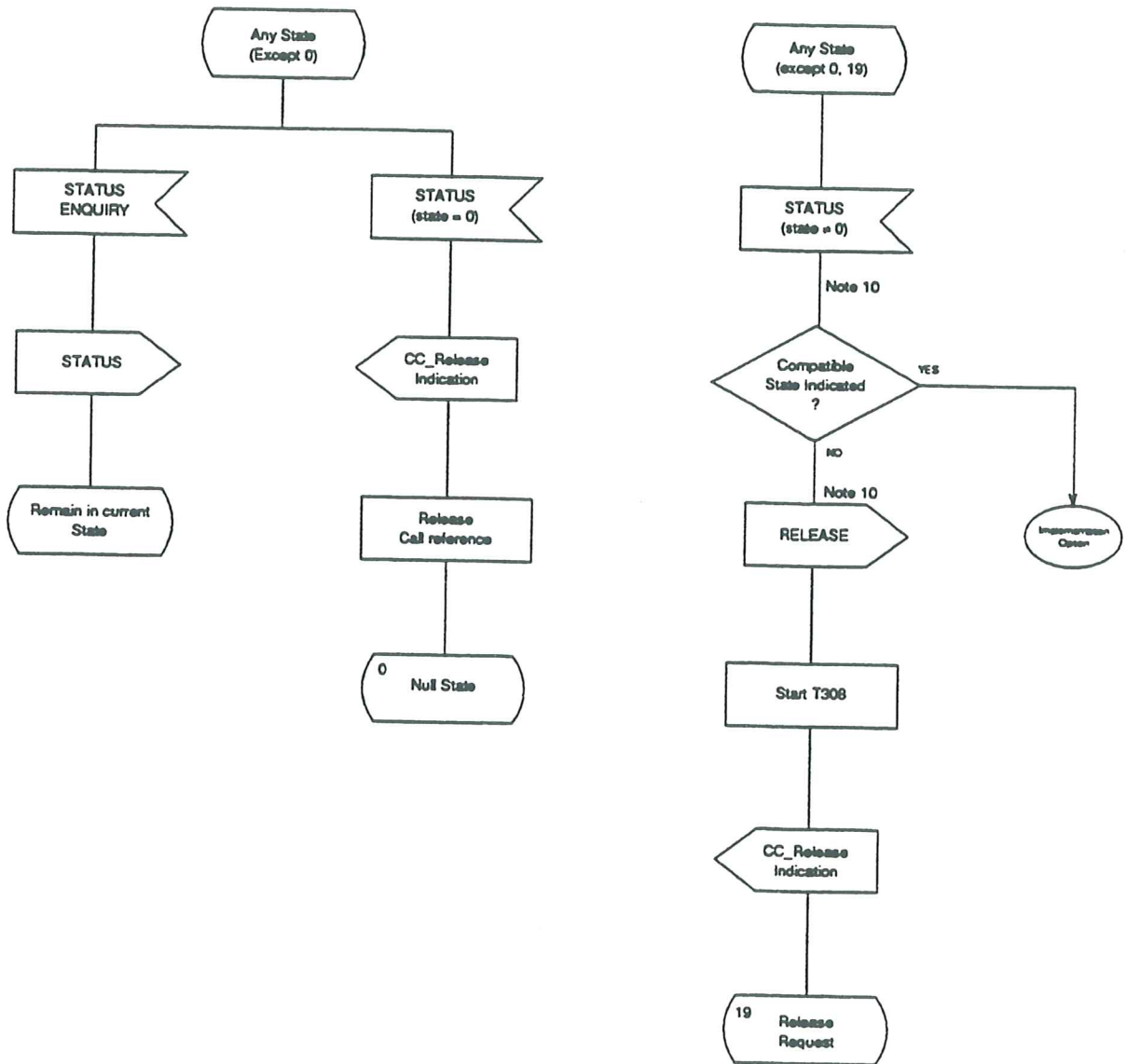

Figure 8 - Protocol Control SDL (Part 17)

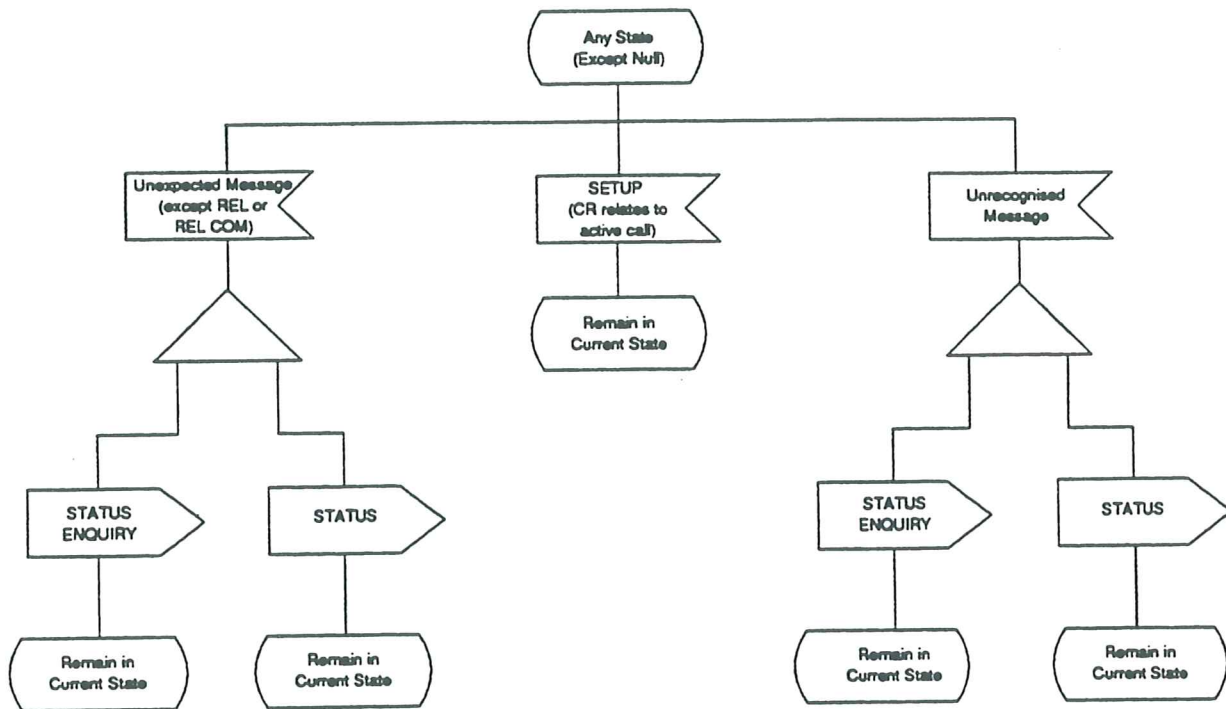

Figure 8 - Protocol Control SDL (Part 18)



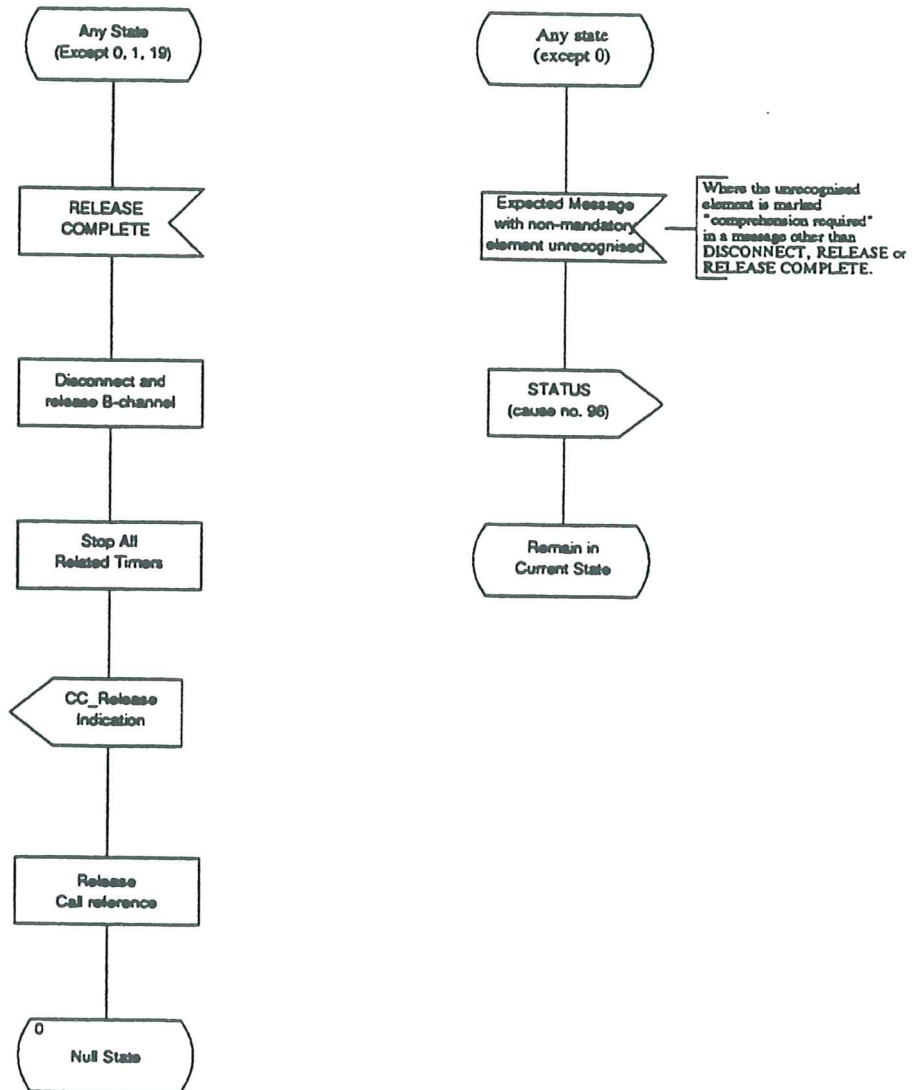

Figure 8 - Protocol Control SDL (Part 19)

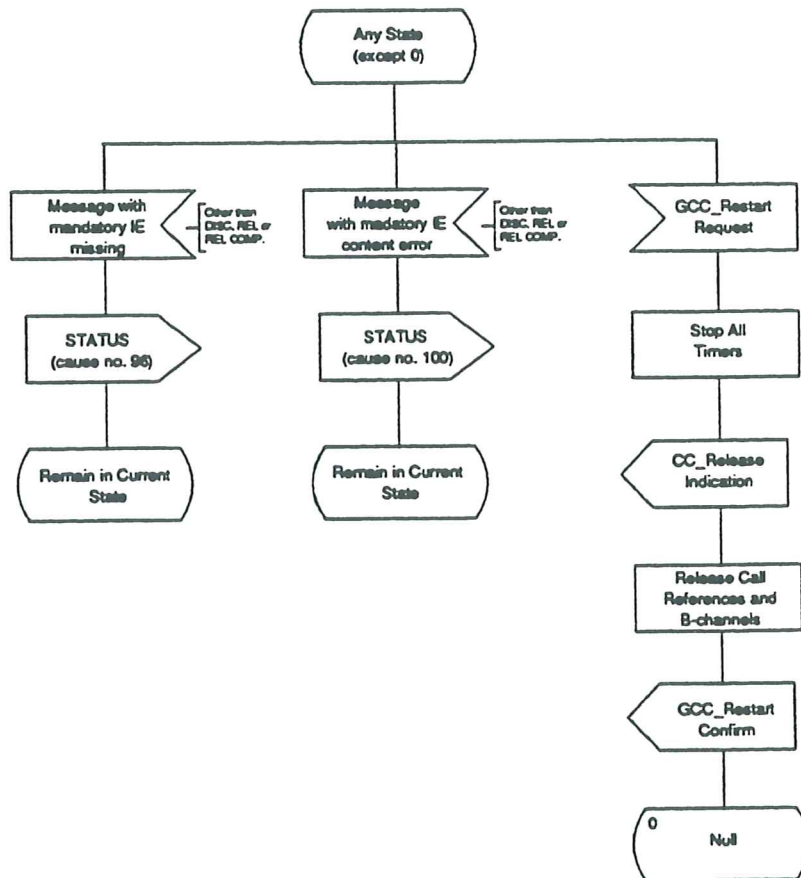

Figure 8 - Protocol Control SDL (Part 20)

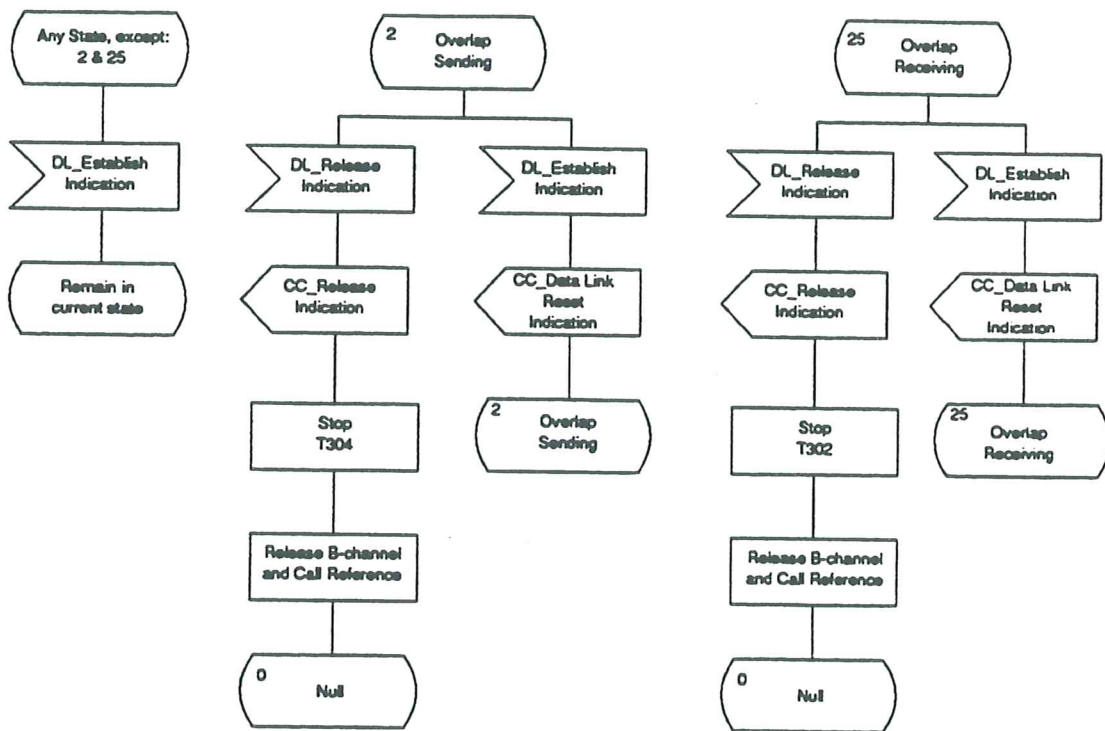

Figure 8 - Protocol Control SDL (Part 21)



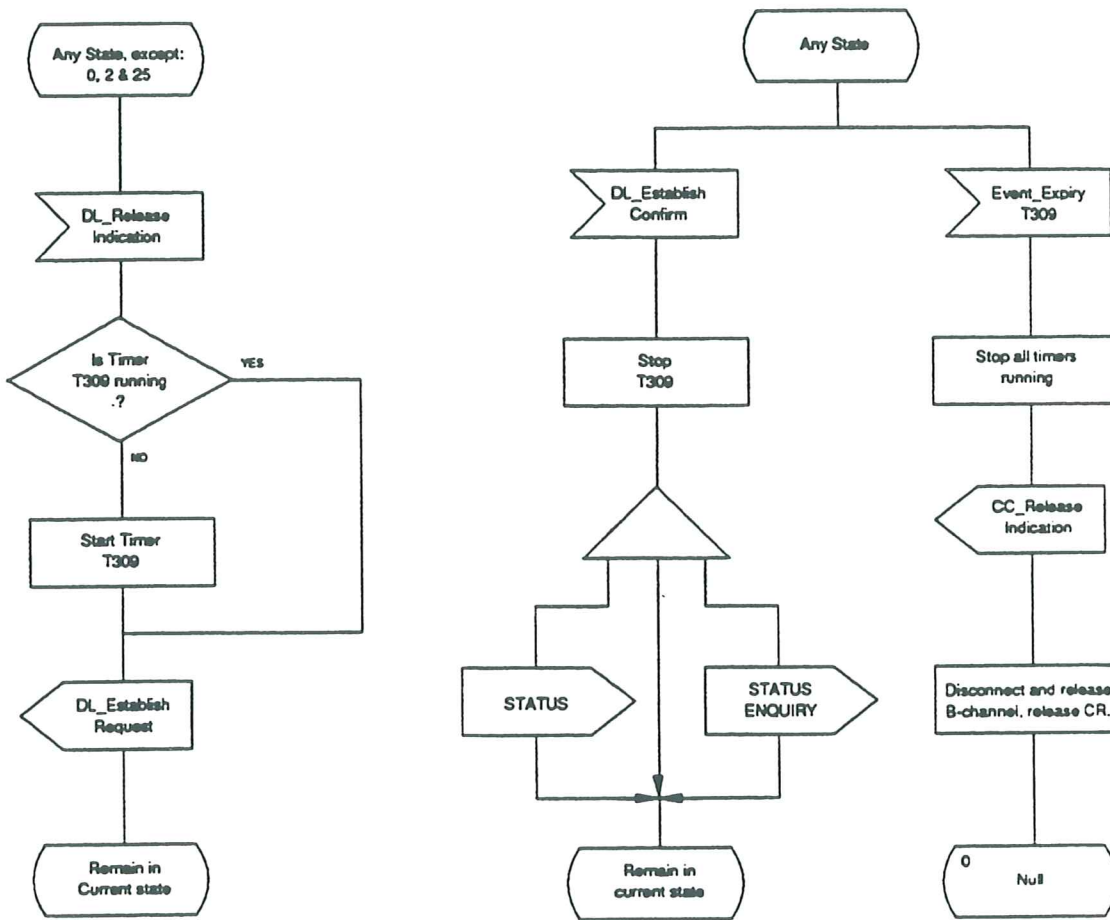

Figure 8 - Protocol Control SDL (Part 22)

Notes to the Protocol Control SDL Diagram:

**NOTE 5**

The sending of *SETUP* a second time on expiry of *T303* is an implementation option.

**NOTE 6**

It is assumed that the decision whether complete information has been received or not, at the expiry of *T302*, will be made by Call Control.

**NOTE 7**

The receipt of *ALERTING* or *CONNECT* as a first response to *SETUP* will not cause a protocol error, even though they would not normally be sent as the first response to the *SETUP* message.

**NOTE 8**

The procedures section allows *RELEASE COMPLETE* or *STATUS* as a response to a *STATUS ENQUIRY* when an entity is in the Null state. 7.3.3.2 allows *RELEASE COMPLETE* (with Cause no. 81) whereas clause 7.4.1 specifies that *STATUS* (with Cause no. 30) should be returned.

**NOTE 9**

The Cause used in the subsequent *RELEASE* message should be no. 99 "information element non-existent or not implemented".

**NOTE 10**

The action to be taken at this point is an implementation option.

**8.5 Transit PTNX Call Control requirements**

This clause specifies those aspects of call control at a Transit PTNX that are necessary for coordinating the incoming side and outgoing side protocol entities.

These procedures refer to the Preceding PTNX and the Subsequent PTNX. These PTNX's are either side of Transit PTNX. This terminology is used in order to clarify the text. The adjectives (Preceding/Subsequent) only have meaning when used in the context of a particular call. The call attempt will have passed from the Preceding PTNX, through the Transit PTNX, to the Subsequent PTNX.

Figure 9 shows the relationship between the Call Control and Incoming and Outgoing Protocol Control within a Transit PTNX.

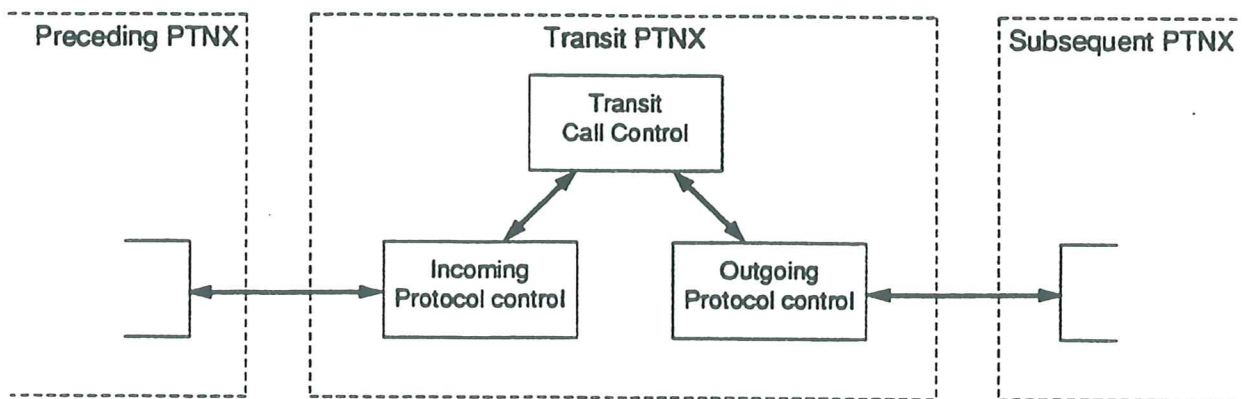

**Figure 9 - Relationship of Call control to Protocol Control**

The Transit PTNX's Call Control states used in this clause are a different set of states from the Protocol States described in earlier clauses. The Transit PTNX's Call Control states are marked as such by "TCC\_" in front of their names. These states are conceptual and used only as an aid to description of the actions required at a Transit

node. As such, they are not directly visible in the protocol and cannot be tested directly. A short description of each of the states is given in 6.6.1.

Any reference to messages received shall be interpreted as meaning a message which has passed the validation checks of Protocol Control and which has therefore resulted in a notification being given to Call Control.

On receipt of a SETUP message (possibly followed by one or more INFORMATION messages containing additional Called Party number information) if the Call control of the PTNX chooses to route the call onwards on a further inter-PTNX link employing the signalling protocol specified in this Standard, it shall conform to the procedures for a Transit PTNX contained in this clause. The procedures defined in this clause show how the message flows of the two interfaces either side of a Transit PTNX are interrelated.

Detailed specification and description language (SDL) diagrams for the procedures specified in this clause are contained in 8.6.

#### 8.5.1 Receipt of Address Information

On receipt of a SETUP message from the Preceding PTNX, the call request shall be processed.

If the call processing is successful, and the Transit PTNX determines that all the address information has been received in the SETUP message, a CALL PROCEEDING message shall be sent to the Preceding PTNX. Then a SETUP message shall be sent to the Subsequent PTNX, and the Transit PTNX shall enter the TCC\_Incoming\_Call\_Proceeding State.

If the call processing is successful, and the Transit PTNX determines that not all the address information has been received in the SETUP message or cannot determine that the address information is complete, a SETUP ACKNOWLEDGE message shall be sent to the Preceding PTNX. If enough digits have been received to route the call a SETUP message shall be sent by the Transit PTNX to the subsequent PTNX and the Transit PTNX shall enter the TCC\_Await\_Additional\_Digits state; else the Transit PTNX shall enter the TCC\_Await\_Digits state.

If the received SETUP message contains a Transit counter information element in which the transit count field has a value that is less than the acceptable (network dependent) limit, that information element shall be included in the SETUP message sent to the Subsequent PTNX. The value of the transit count field in the outgoing Transit counter information element shall be one greater than the value received.

If the received SETUP message contains a Transit counter information element in which the transit count field has a value that is greater than or equal to the acceptable (network dependent) limit of Transit PTNX's through which the call may be routed, and the PTNX is unable to become a Terminating or Outgoing Gateway PTNX, the call shall be rejected.

If the received SETUP message does not contain a Transit counter information element, the transit PTNX may include a Transit counter information element in the SETUP message sent to the Subsequent PTNX. The value of the transit count field in this element shall be set to an initial value.

If the call processing is not successful, then a RELEASE COMPLETE message shall be sent to the Preceding PTNX, and the Transit PTNX shall remain in the TCC\_Idle state.

#### 8.5.2 State TCC\_Await Digits

Additional address information is received in INFORMATION messages. Once enough address information has been received in order to route the call, a SETUP message may be sent to the Subsequent PTNX. If, on analysis of the digits, the Transit PTNX identifies that there are no more digits expected, a CALL PROCEEDING message shall be sent to the preceding PTNX and the Transit PTNX shall enter the TCC\_Incoming\_Call\_Proceeding state; otherwise the Transit PTNX shall enter the TCC\_Await\_Additional\_Digits state.

If a DISCONNECT message is received from the Preceding PTNX, the call shall be cleared as described in 8.5.10. If a RELEASE or RELEASE COMPLETE message is received from the Preceding PTNX, the call shall be cleared as described in 8.5.10.

If, for any reason, the Transit PTNX decides to abort the call, it shall clear the call by sending a DISCONNECT message to the Preceding PTNX and continuing normal clearing procedures as described in 8.5.10.



If the Protocol Control of the incoming side of the interface notifies the Transit call control that T302 has expired, then the PTNX may either clear the call by sending DISCONNECT to the Preceding PTNX, or attempt some other (unspecified) procedure.

### 8.5.3 State TCC\_Await Additional Digits

Any additional address information which is received in INFORMATION messages shall be buffered in the Transit PTNX whilst waiting for a response to the SETUP message that has been sent to the Subsequent PTNX. If the Transit PTNX determines that the address information it has received is complete, a CALL PROCEEDING message shall be sent to the preceding PTNX and the Transit PTNX shall enter the TCC\_Incoming\_Call\_Proceeding state; otherwise it shall remain in the TCC\_Await\_Additional\_Digits state.

If a SETUP ACKNOWLEDGE message is received from the Subsequent PTNX, and the channel indicated is acceptable, then the Transit PTNX shall enter the TCC\_Overlap state and may through connect the B-channel. Any buffered address information shall be forwarded to the subsequent PTNX in an INFORMATION message. If the channel indicated is not acceptable the call shall be cleared towards the Subsequent PTNX using a RELEASE message and the PTNX shall either clear the call towards the Preceding PTNX using a DISCONNECT message, or may attempt some other (unspecified) procedure.

If a RELEASE COMPLETE message is received from the Subsequent PTNX the call may either be cleared as described in 8.5.10, or the PTNX may attempt some other (unspecified) procedure.

If a CALL PROCEEDING message is received from the Subsequent PTNX and the channel indicated is acceptable, no more address information shall be sent to the Subsequent PTNX, and the Transit PTNX shall enter the TCC\_Transit\_Call\_Proceeding state and may through connect the B-channel. Any buffered address information shall be discarded and any further INFORMATION messages received shall be ignored. If the channel indicated is not acceptable the call shall be cleared towards the Subsequent PTNX using a RELEASE message and the PTNX shall either clear the call towards the Preceding PTNX using a DISCONNECT message, or may attempt some other (unspecified) procedure.

If a DISCONNECT message is received from the Preceding PTNX, the call shall be cleared as described in 8.5.10.

If a RELEASE or RELEASE COMPLETE message is received from the Preceding PTNX, the call shall be cleared as described in 8.5.10.

If an ALERTING message is received from the Subsequent PTNX and the channel indicated is acceptable, the transit node may through connect the B-channel. An ALERTING message shall be sent to the Preceding PTNX and the Transit PTNX shall enter the TCC\_Call\_Alerting state. If the received ALERTING message contained CCITT progress description no. 1 or no. 8, the B-channel should be through connected in the backward direction, if this has not already occurred. If the channel indicated is not acceptable the call shall be cleared towards the Subsequent PTNX using a RELEASE message and the PTNX shall either clear the call towards the Preceding PTNX as described in 8.5.10, or may attempt some other (unspecified) procedure.

If a CONNECT message is received from the Subsequent PTNX and the channel indicated is acceptable, the transit node shall through connect the B-channel (in both directions) - if not already connected - send a CONNECT message to the Preceding PTNX and enter the TCC\_Call\_Active state. If the channel indicated is not acceptable the call shall be cleared towards the Subsequent PTNX using a RELEASE message and the PTNX shall either clear the call towards the Preceding PTNX as described in 8.5.10, or may attempt some other (unspecified) procedure.

If, for any reason, the Transit PTNX decides to abort the call, it shall clear the call in both directions as described in 8.5.10.

If the Protocol Control of the incoming side of the interface notifies Transit Call Control that T302 has expired, then the PTNX shall either send a CALL PROCEEDING message to the Preceding PTNX and enter the TCC\_Incoming\_Call\_Proceeding state, or may attempt some other (unspecified) procedure.

### 8.5.4 State TCC\_Overlap

Any additional address information which is received in INFORMATION messages shall be sent on to the Subsequent PTNX in INFORMATION messages. If it is known that the address information is complete, a Sending complete information element may optionally be sent in an INFORMATION message.



If a CALL PROCEEDING message is received from the Subsequent PTNX no more address information shall be sent to the Subsequent PTNX, and the Transit PTNX shall enter the TCC\_Transit\_Call\_Proceeding state.

If the Transit PTNX determines that it has received all the address information (e.g. on receipt of CALL PROCEEDING from the Subsequent PTNX, on receipt of a Sending complete information element from the Preceding PTNX, or by digit analysis), a CALL PROCEEDING message shall be sent to the Preceding PTNX, and the Transit PTNX shall enter the TCC\_Transit\_Call\_Proceeding state; else it shall stay in the TCC\_Overlap state.

If a PROGRESS message is received from the Subsequent PTNX, a PROGRESS message shall be sent to the Preceding PTNX. If this message contains CCITT progress description no. 1 or no. 8, the B-channel shall be through connected in the backward direction if this has not already occurred.

If an ALERTING message is received from the Subsequent PTNX an ALERTING message shall be sent to the Preceding PTNX, and the Transit PTNX shall enter the TCC\_Call\_Alerting state. If this message contains CCITT progress description no. 1 or no. 8, the B-channel shall be through connected in the backward direction, if this has not already occurred.

If a CONNECT message is received from the Subsequent PTNX, a CONNECT message shall be sent to the Preceding PTNX and the PTNX shall through connect the B-channel in both directions (unless it has already done so) and enter the TCC\_Call\_Active state.

If a DISCONNECT message is received from the Preceding PTNX the call shall be cleared as described in 8.5.10.

If a DISCONNECT message is received from the Subsequent PTNX's the call may either be cleared as described in 8.5.10, or other procedures may be attempted by the Transit PTNX; however, the clearing sequence with the subsequent PTNX shall be completed as described in 8.5.10.

If a RELEASE or RELEASE COMPLETE message is received from the Preceding PTNX the call shall be cleared as described in 8.5.10.

If a RELEASE or RELEASE COMPLETE message is received from the Subsequent PTNX's the call may either be cleared using procedures as described in 8.5.10, or other procedures may be attempted by the Transit PTNX.

If the Protocol Control of the incoming side of the interface notifies the Transit call control that T302 has expired, then the PTNX shall either send a CALL PROCEEDING message to the Preceding PTNX and enter the TCC\_Transit\_Call\_Proceeding state, or attempt some other (unspecified) procedure.

If, for any reason, the Transit PTNX decides to abort the call, it shall clear the call in both directions as described in 8.5.10.

#### **8.5.5 Channel Through Connection Procedures**

During call setup, the Transit PTNX shall through connect the agreed B-channel to the Subsequent PTNX as outlined below.

The earliest point at which through connection may occur (in either forward, backward or both directions) is when the Transit PTNX receives the first response to an outgoing SETUP message.

The latest point that through connection in the backward direction shall occur is on receipt of an ALERTING, PROGRESS (with CCITT progress description no. 1 or no. 8) or CONNECT message from the Subsequent PTNX. The latest point that through connection in the forward direction shall occur is on receipt of a CONNECT message from the Subsequent PTNX.

#### **NOTE 11**

*It is recommended that through connection in both directions is achieved as early as possible during call set up. This is particularly appropriate for services providing the conveyance of speech information. Delaying through connection, particularly in the backward direction, to a later stage during call setup may lead to "speech clipping".*

#### **8.5.6 State TCC\_Incoming Call Proceeding**

If a SETUP ACKNOWLEDGE message is received from the Subsequent PTNX and the channel indicated is acceptable, the Transit PTNX may through connect the B-channel and shall enter the



TCC\_Transit\_Call\_Proceeding state. If the channel indicated is not acceptable, the call shall be cleared towards the Subsequent PTNX using a RELEASE message and the PTNX shall either clear the call towards the Preceding PTNX using a DISCONNECT message, or may attempt some other (unspecified) procedure.

If a RELEASE COMPLETE message is received from the Subsequent PTNX the call shall either be cleared using procedures as described in 8.5.10, or other procedures may be attempted by the Transit PTNX.

If a CALL PROCEEDING message is received from the Subsequent PTNX and the channel indicated is acceptable, the Transit PTNX may through connect the B-channel and shall enter the TCC\_Transit\_Call\_Proceeding state. If any further INFORMATION messages are received they shall be ignored. If the channel indicated is not acceptable, the call shall be cleared towards the Subsequent PTNX using a RELEASE message. The PTNX shall either clear the call towards the Preceding PTNX using a DISCONNECT message, or may attempt some other (unspecified) procedure.

If an ALERTING message is received from the subsequent PTNX and, if a channel number is included in the ALERTING message, the indicated channel number is acceptable, an ALERTING message shall be sent to the Preceding PTNX. The Transit PTNX shall enter the TCC\_Call\_Alerting state. If the received ALERTING message contains CCITT progress description no. 1 or no. 8, the B-channel should be cut-through connected in the backward direction if this has not already occurred. If a channel number is indicated and it is not acceptable, the call shall be cleared towards the Subsequent PTNX using a RELEASE message. The PTNX shall either clear the call towards the Preceding PTNX as described in 8.5.10, or may attempt some other (unspecified) procedure.

If a CONNECT message is received from the subsequent PTNX and, if a channel number is included in the CONNECT message, the indicated channel number is acceptable, a CONNECT message shall be sent to the Preceding PTNX. The Transit PTNX shall through connect the B-channel in both directions (unless it has already done so) and enter the TCC\_Call\_Active state. If a channel number is indicated and it is not acceptable, the call shall be cleared towards the Subsequent PTNX using a RELEASE message. The PTNX shall either clear the call towards the Preceding PTNX as described in 8.5.10, or may attempt some other (unspecified) procedure.

If a DISCONNECT message is received from the Preceding PTNX the call shall be cleared as described in 8.5.10.

If a RELEASE or RELEASE COMPLETE message is received from the Preceding PTNX the call shall be cleared as described in 8.5.10.

If, for any reason, the Transit PTNX decides to abort the call, it shall clear the call in both directions as described in 8.5.10.

#### **8.5.7 State TCC\_Transit Call Proceeding**

If a PROGRESS message is received from the Subsequent PTNX a PROGRESS message shall be sent to the Preceding PTNX. If this message contains CCITT progress description no. 1 or no. 8, the B-channel shall be through connected in the backward direction if this has not already occurred.

If a CALL PROCEEDING message is received from the Subsequent PTNX, the Transit PTNX shall remain in the TCC\_Transit\_Call\_Proceeding state. If any further INFORMATION messages are received they shall be ignored.

If an ALERTING message is received from the Subsequent PTNX an ALERTING message shall be sent to the Preceding PTNX, and the Transit PTNX shall enter the TCC\_Call\_Alerting state. If this message contains CCITT progress description no. 1 or no. 8, the B-channel shall be through connected in the backward direction if this has not already occurred.

If a CONNECT message is received from the Subsequent PTNX, a CONNECT message shall be sent to the Preceding PTNX and the Transit PTNX shall through connect the B-channel in both directions (unless it has already done so) and enter the TCC\_Call\_Active state.

If a DISCONNECT message is received from the Preceding PTNX the call shall be cleared as described in 8.5.10.

If a DISCONNECT message is received from the Subsequent PTNX, the call shall either be cleared using procedures as described in 8.5.10, or other procedures may be attempted by the Transit PTNX.

If a RELEASE or RELEASE COMPLETE message is received from the Preceding PTNX the call shall be cleared as described in 8.5.10.

If a RELEASE or RELEASE COMPLETE message is received from the Subsequent PTNX the call shall either be cleared using procedures as described in 8.5.10, or other procedures may be attempted by the Transit PTNX.

If, for any reason, the Transit PTNX decides to abort the call, it shall clear the call in both directions as described in 8.5.10.

#### **8.5.8 State TCC\_Call Alerting**

If a PROGRESS message is received from the Subsequent PTNX a PROGRESS message shall be sent to the Preceding PTNX. If this message contains CCITT progress description no. 1 or no. 8, the B-channel shall be through connected in the backward direction if this has not already occurred.

If a CONNECT message is received from the Subsequent PTNX a CONNECT message shall be sent to the Preceding PTNX and the Transit PTNX shall through connect the B-channel in both directions (unless it has already done so) and enter the TCC\_Call\_Active state.

If a DISCONNECT message is received from the Preceding PTNX the call shall be cleared as described in 8.5.10.

If a DISCONNECT message is received from the Subsequent PTNX the call shall be cleared as described in 8.5.10.

If a RELEASE or RELEASE COMPLETE message is received from the Preceding PTNX the call shall be cleared as described in 8.5.10.

If a RELEASE or RELEASE COMPLETE message is received from the Subsequent PTNX the call shall be cleared as described in 8.5.10.

If, for any reason, the Transit PTNX decides to abort the call, it shall clear the call in both directions as described in 8.5.10.

#### **8.5.9 State TCC\_Call Active**

If a DISCONNECT message is received from either the Preceding or Subsequent PTNX's, the call shall be cleared as described in 8.5.10.

If a RELEASE or RELEASE COMPLETE message is received from either the Preceding or Subsequent PTNX's, the call shall be cleared as described in 8.5.10.

If a PROGRESS message is received from the Subsequent PTNX a PROGRESS message shall be sent to the Preceding PTNX.

If a PROGRESS message is received from the Preceding PTNX a PROGRESS message shall be sent to the Subsequent PTNX.

If, for any reason, the Transit PTNX decides to abort the call, it shall clear the call in both directions as described in 8.5.10.

#### **8.5.10 Clearing at a Transit PTNX**

##### **8.5.10.1 Call Clearing not Initiated by the Transit PTNX**

- i) On receipt of a DISCONNECT, RELEASE or RELEASE COMPLETE message from the Preceding PTNX, the Transit PTNX shall:
  - If the B-channel to be used has been agreed between the Outgoing side of the Transit PTNX and the Incoming side of the Subsequent PTNX, disconnect the appropriate B-channel, and send a DISCONNECT message to the Subsequent PTNX. If a DISCONNECT message was received from the Preceding PTNX, a RELEASE message shall be sent to the Preceding PTNX.



The Transit PTNX shall enter the TCC\_Await\_Outgoing\_Release state. When a RELEASE or RELEASE COMPLETE message is received from the Subsequent PTNX the Transit PTNX shall release any assigned resources and revert to the TCC\_Idle state.

- If the B-channel to be used has not been agreed between the Outgoing side of the transit PTNX and the Incoming side of the Subsequent PTNX (i.e. the first response to an outgoing SETUP message has not been received), proceed according to the current Call Control state:
  - If Call Control is in either of the TCC\_Await\_Additional\_Digits or TCC\_Incoming\_Call\_Proceeding states, the Transit PTNX shall send a RELEASE message to the Subsequent PTNX. If DISCONNECT was received from the Preceding PTNX, a RELEASE message shall be sent to the Preceding PTNX. The Transit PTNX shall enter the TCC\_Idle state.
  - If Call Control is in the TCC\_Await\_Digits state, the Transit PTNX shall send a RELEASE message to the Preceding PTNX (if DISCONNECT was received from the Preceding PTNX) and enter the TCC\_Idle state.
- ii) On receipt of a DISCONNECT, RELEASE or RELEASE COMPLETE message from the Subsequent PTNX, the Transit PTNX shall disconnect the appropriate data-channel and send a DISCONNECT message to the Preceding PTNX. Alternatively, during call establishment, if the call has not yet reached the TCC\_Call\_Alerting state, the transit PTNX may attempt some other (unspecified) procedure instead of sending DISCONNECT to the Preceding PTNX. If a DISCONNECT message was received from the Subsequent PTNX, the Transit PTNX shall send a RELEASE message to the Subsequent PTNX.

If a DISCONNECT message was sent to the preceding PTNX, the Transit PTNX shall enter the TCC\_Await\_Incoming\_Release state. When a RELEASE message is received from the Preceding PTNX, the Transit PTNX shall release any assigned resources and revert to the TCC\_Idle state.

#### 8.5.10.2 Call Clearing Initiated by the Transit PTNX

If a transit PTNX decides to abort a call it may send, in both directions, a clearing message appropriate to the current Protocol Control state. Each side of the PTNX shall then continue normal clearing procedures independently of the other.

Alternatively, where an in-band tone or announcement is appropriate (i.e. if it conveys information which is not conveyable by signalling), the transit PTNX, instead of sending a clearing message, may connect an in-band tone or announcement to either (or both) sides of the PTNX and transmit a PROGRESS message, containing CCITT progress description no. 8 and an appropriate cause. If Call Control is in the TCC\_Call\_Active state, the announcement may optionally be applied without sending a PROGRESS message, as the B-channel will be through connected in both directions at this stage.

Call control of the Transit PTNX shall ensure that, for each side, if an indication of clearing has not been received by the time the tone or announcement is complete (or has been applied for sufficient time), normal clearing procedures (described in 8.5.10) shall be invoked.

#### 8.5.11 Handling of Basic Call information elements at a Transit PTNX

This clause applies only to information elements contained within messages which may (but need not) be passed on by a transit PTNX. Examples of these are SETUP, INFORMATION, ALERTING, CONNECT, PROGRESS and DISCONNECT.

##### 8.5.11.1 Mandatory information elements

All mandatory information elements will (by definition) appear in messages on both sides of the Transit PTNX. Where necessary they will be processed within Transit PTNX and may be different either side of the PTNX.

##### 8.5.11.2 Non-Mandatory information elements

Non-Mandatory information elements fall into three categories:

- Category 1: If they are present, they shall be processed in the Transit PTNX and shall be passed on to the next PTNX if the message is passed on. They may be locally generated.

Category 2: If they are present, they shall not be processed at a Transit PTNX and shall be passed transparently onto the next PTNX.

Category 3: If they are present, they shall be processed in the Transit PTNX and may be passed on to the next PTNX if the message is passed on. They may be locally generated.

The three categories are identified using their information element Identifiers. Refer to table 4 for listing which of the three categories each of the Non-Mandatory information elements are in.

**Table 4 - Non-mandatory information element Categories**

information element	Category 1	Category 2	Category 3	Notes
Called party number	•			May be modified
Called party subaddress		•		
Calling party number	•			May be modified
Calling party subaddress		•		
Cause (in PROGRESS)	•			
Connected number	•			May be modified
Connected subaddress		•		
High layer compatibility		•		
Low layer compatibility		•		
Party category		•		
Progress indicator	•			
Sending complete			•	
Transit counter	•			Modified (see 8.5.1)

**8.6 Transit Call Control SDL Diagrams (informative)**

Figure 11 in this clause contains an SDL diagram which provides an example of the call control procedures as described in 8.5. The procedures illustrated are not intended to be complete, merely an example of the procedures described in the text.

Figure 10 provides the key to the symbols used in figure 11. The input symbols from the left hand side contain primitives from a number of sources, each identified by a prefix to the primitive name as indicated in table 5. The output symbols to the left hand side contain primitives to the incoming side Protocol Control entity. The input/output symbols to the right hand side contain primitives which are sent from/to the outgoing side Protocol Control entity.

**Table 5 - Key to Primitive types in Call Control SDL Diagrams**

Prefix	Primitive from/to:
CC_ Event_	Protocol Control An entity which provides Call Control with notification of call related events

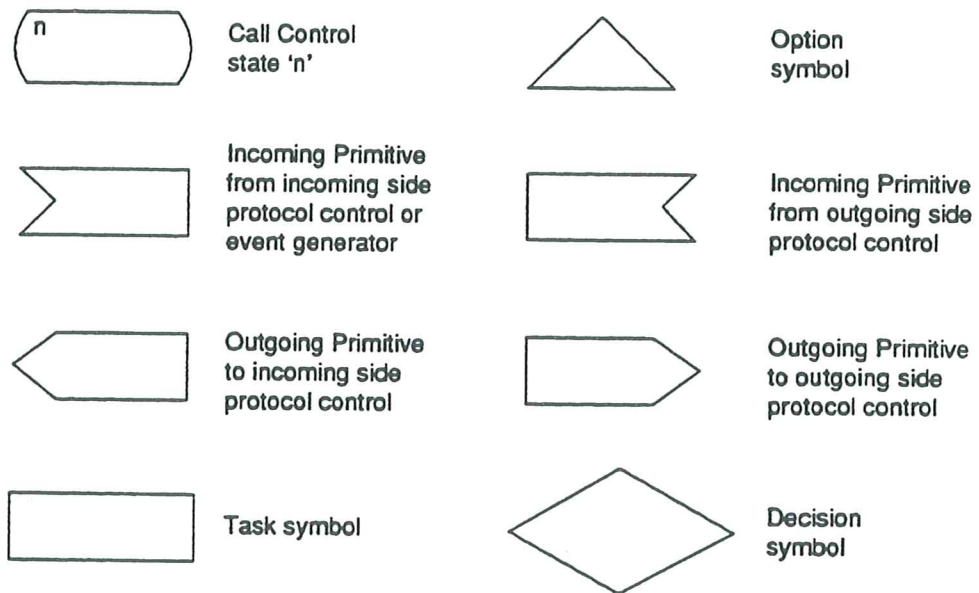

Figure 10 - Key to Transit Call Control SDL Diagram



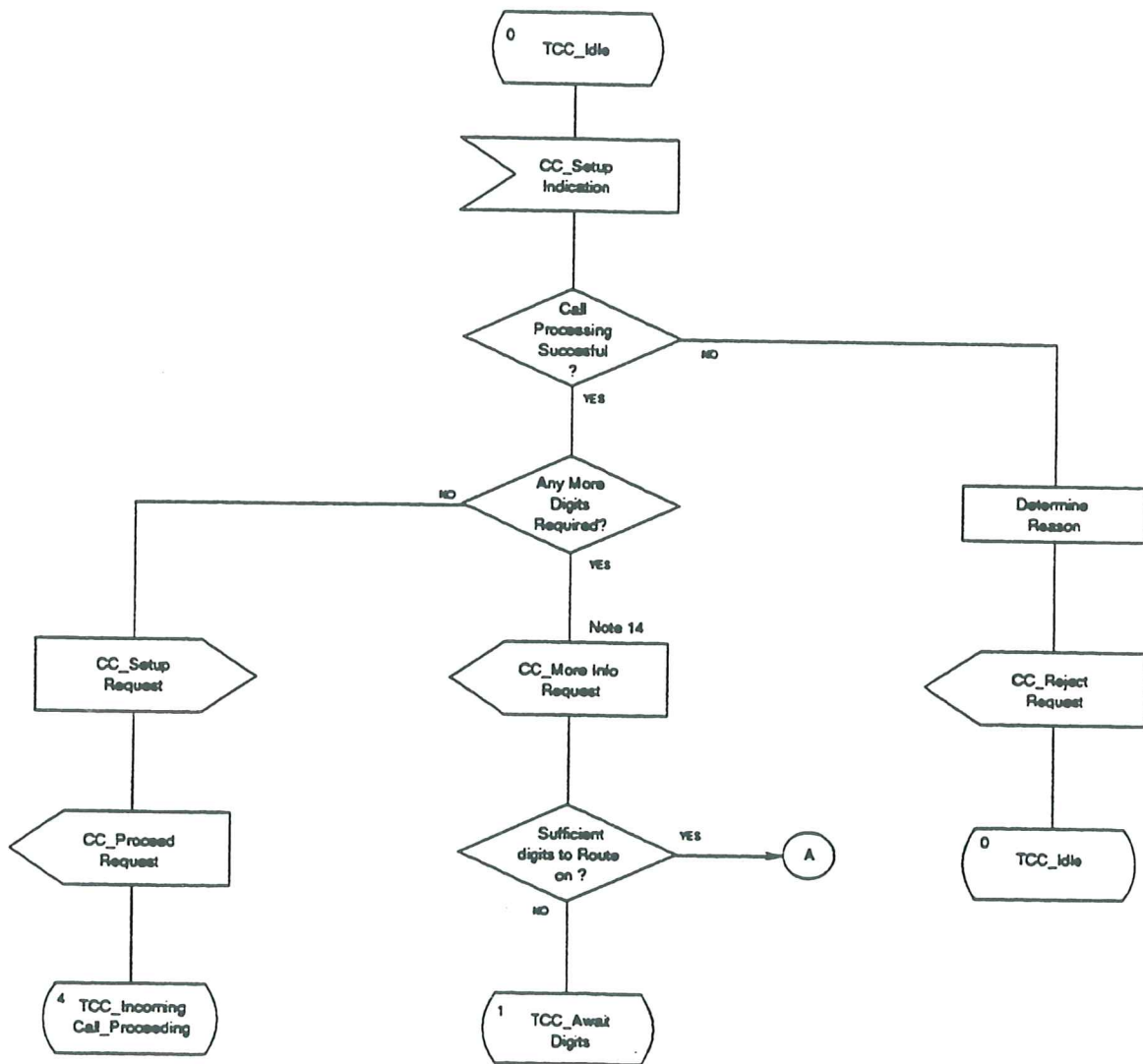

Figure 11 - Transit Call Control SDL Diagram (Part 1)

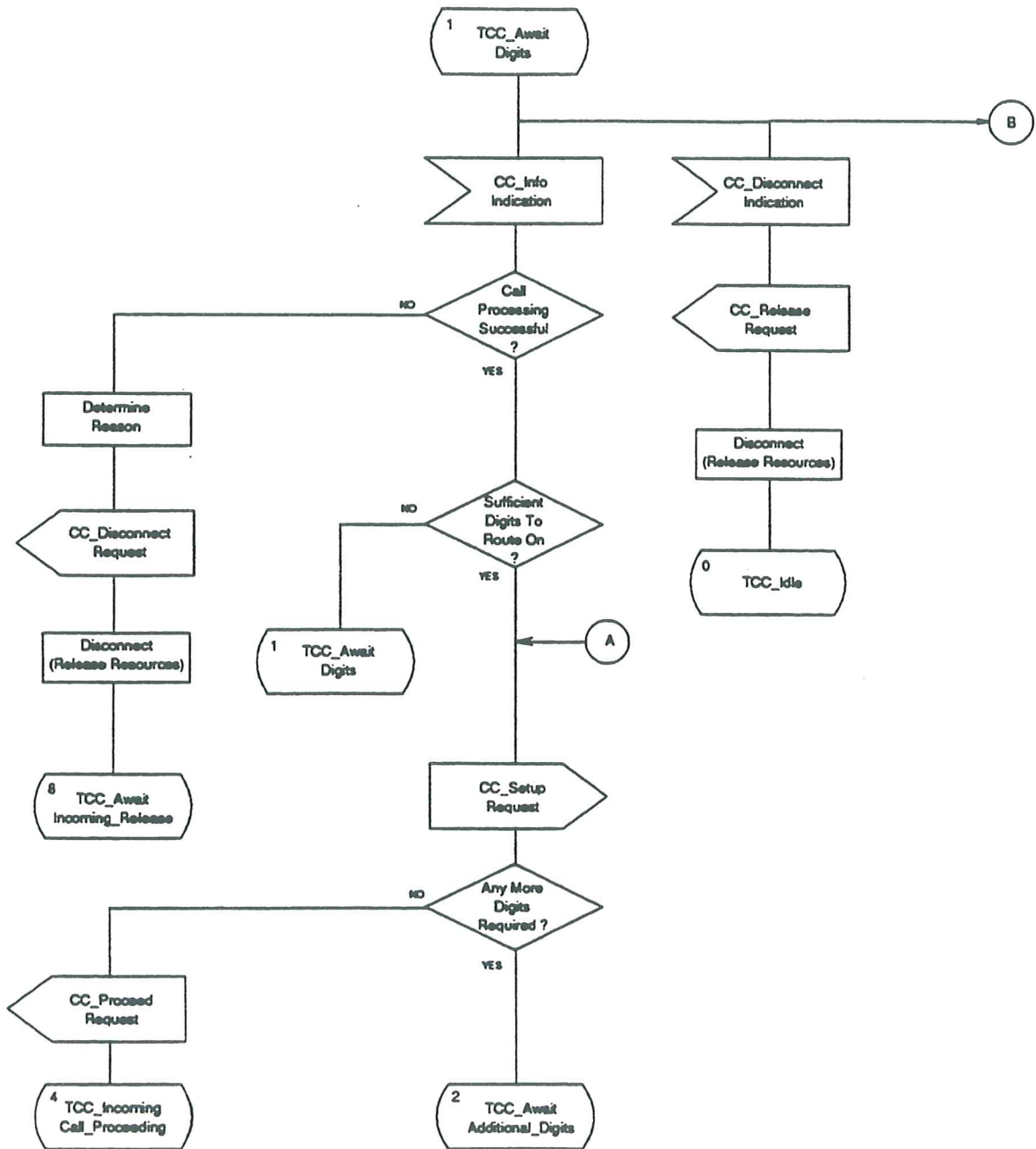

Figure 11 -Transit Call Control SDL Diagram (Part 2)

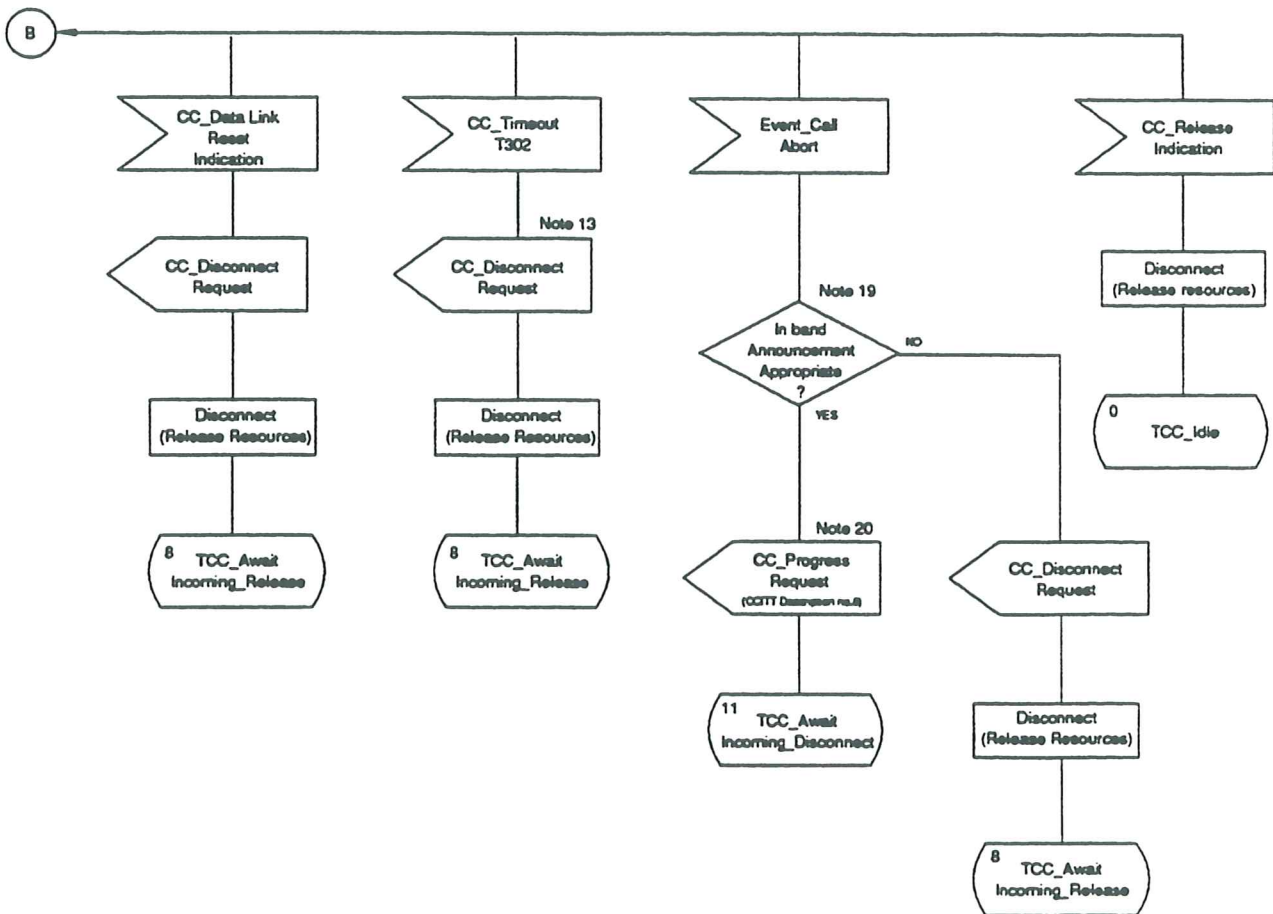

Figure 11 - Transit Call Control SDL Diagram (Part 3)



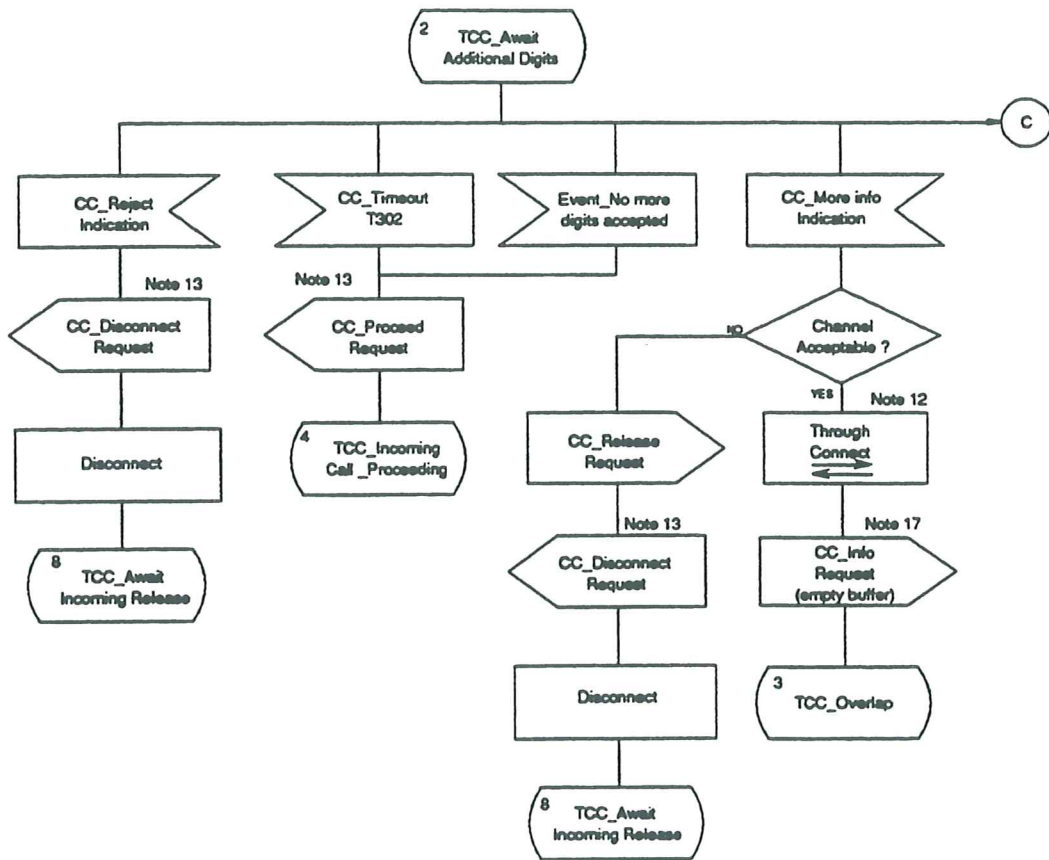

Figure 11 - Transit Call Control SDL Diagram (Part 4)

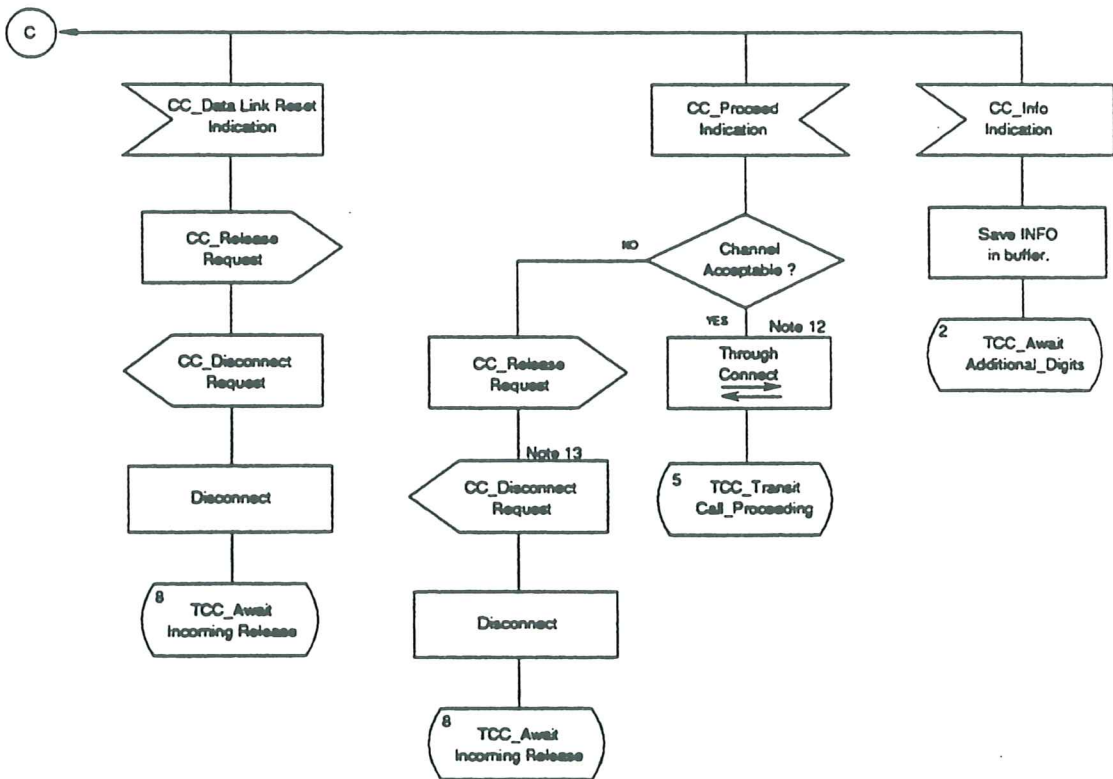

Figure 11 - Transit Call Control SDL Diagram (Part 5)

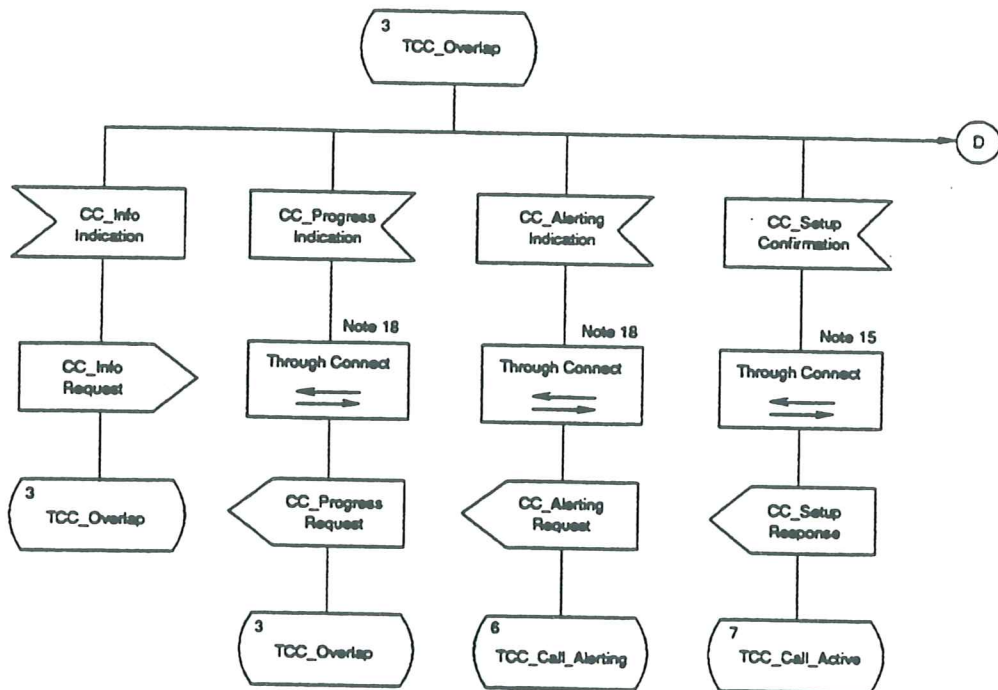

Figure 11 - Transit Call Control SDL Diagram (Part 6)



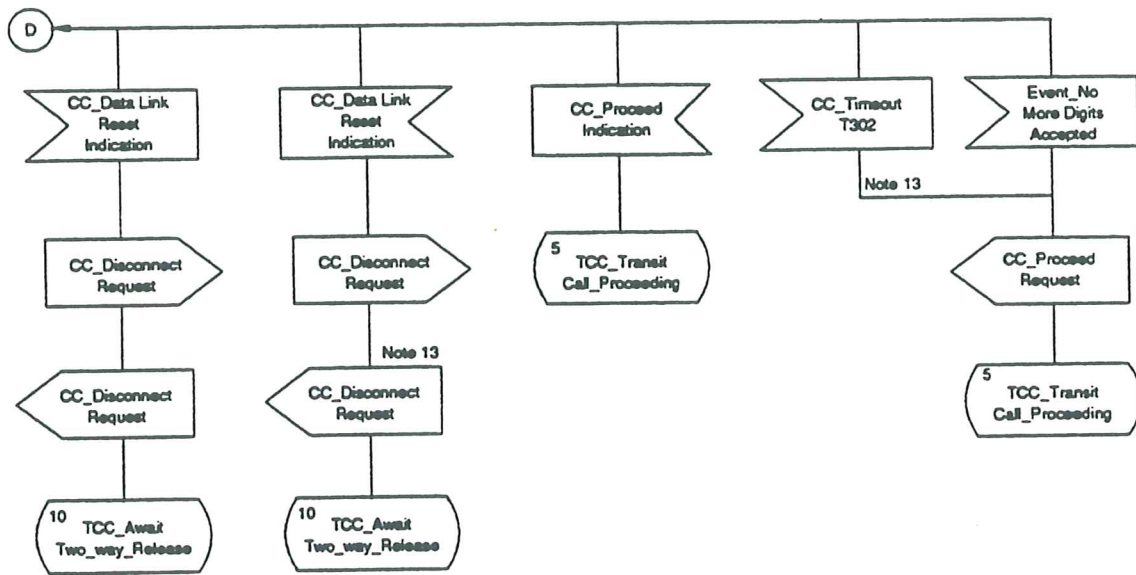

Figure 11 - Transit Call Control SDL Diagram (Part 7)

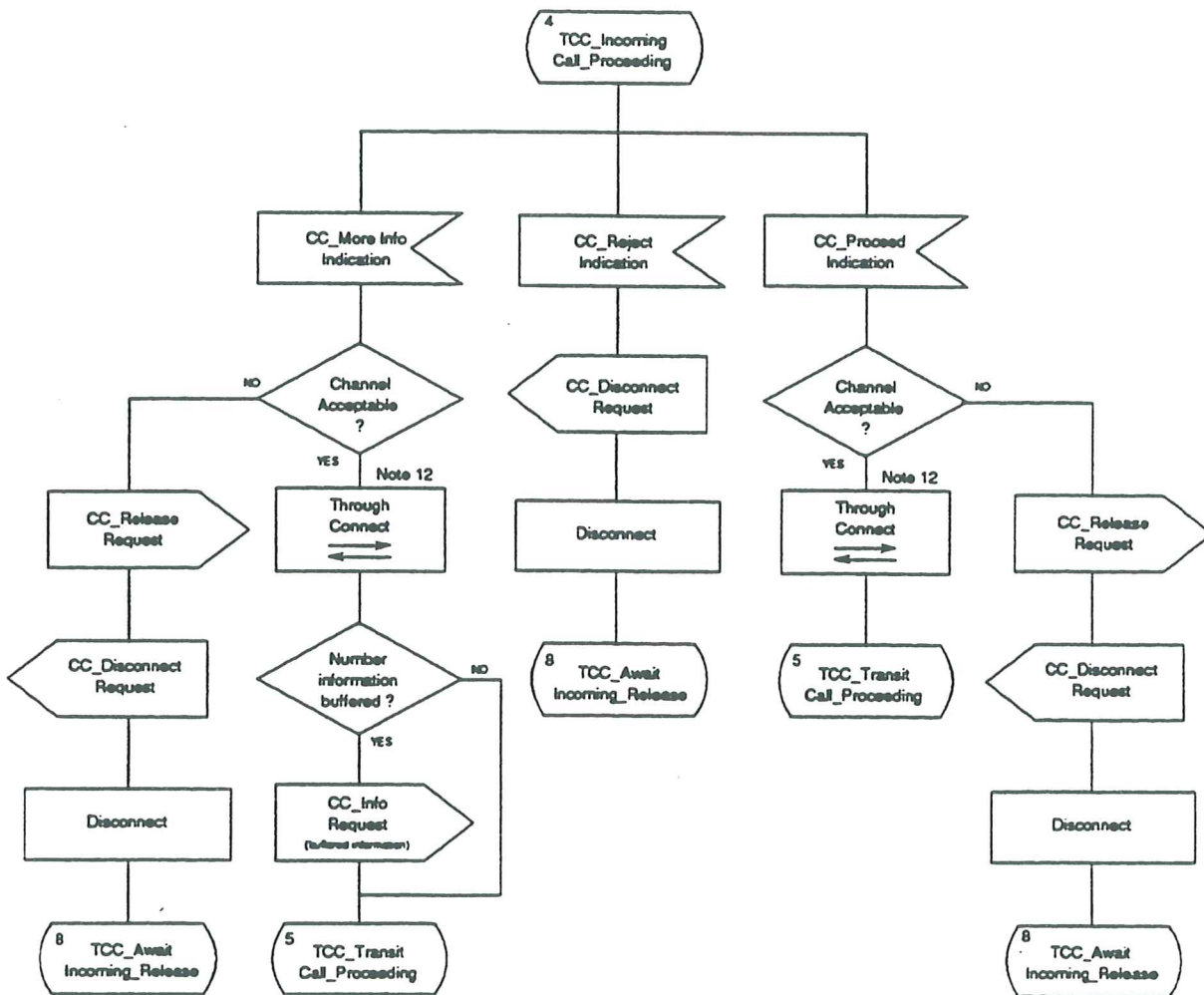

Figure 11 - Transit Call Control SDL Diagram (Part 8)

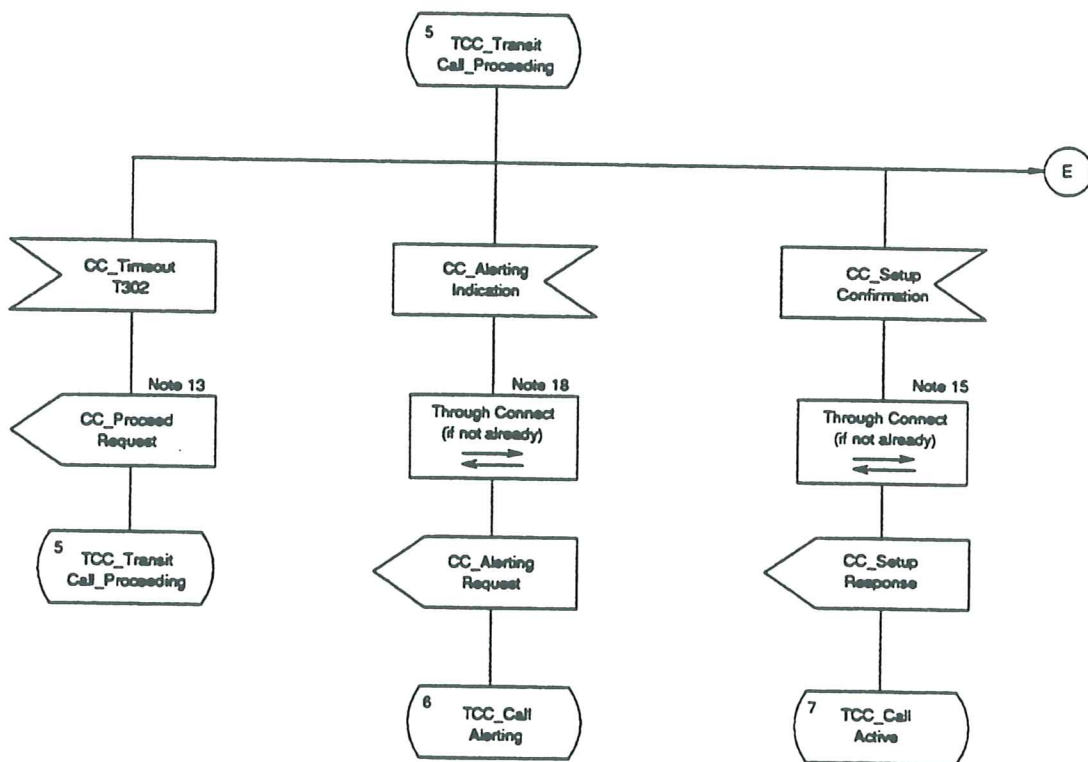

Figure 11 - Transit Call Control SDL Diagram (Part 9)



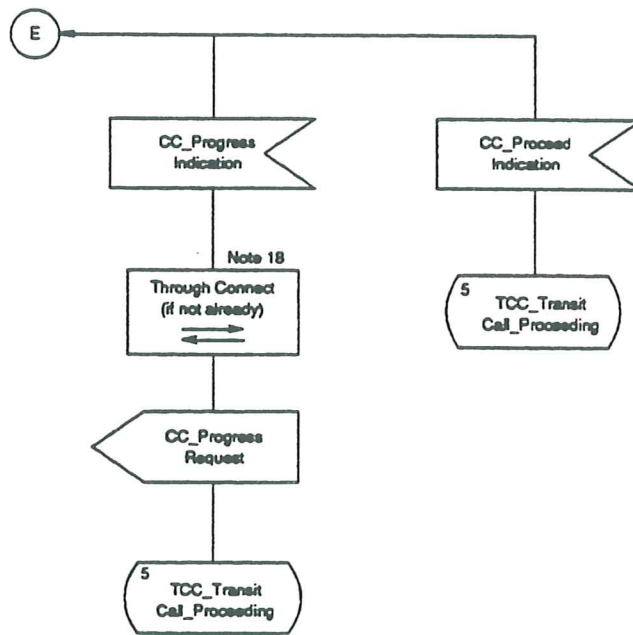

Figure 11 - Transit Call Control SDL Diagram (Part 10)

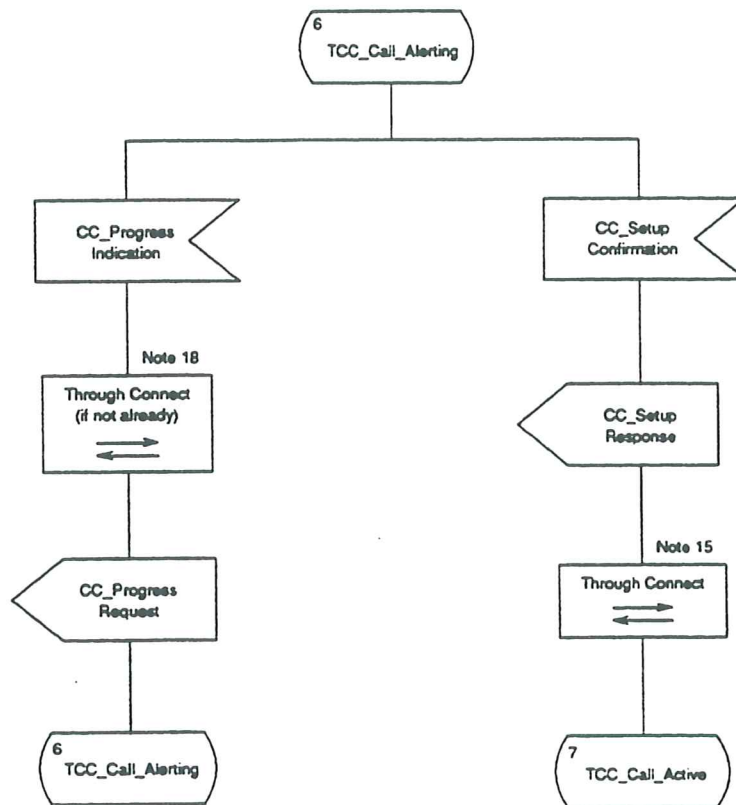

Figure 11 - Transit Call Control SDL Diagram (Part 11)

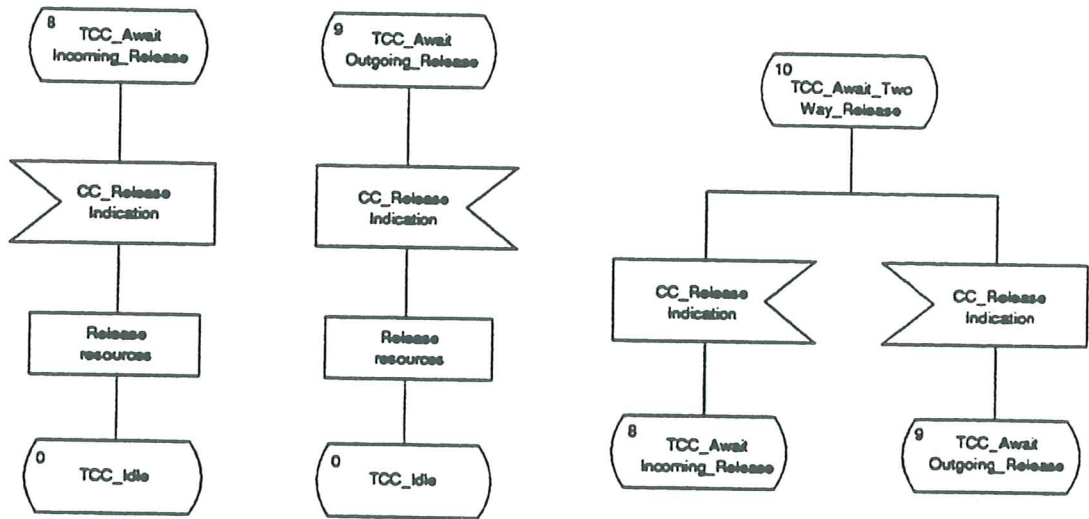

Figure 11 - Transit Call Control SDL Diagram (Part 12)



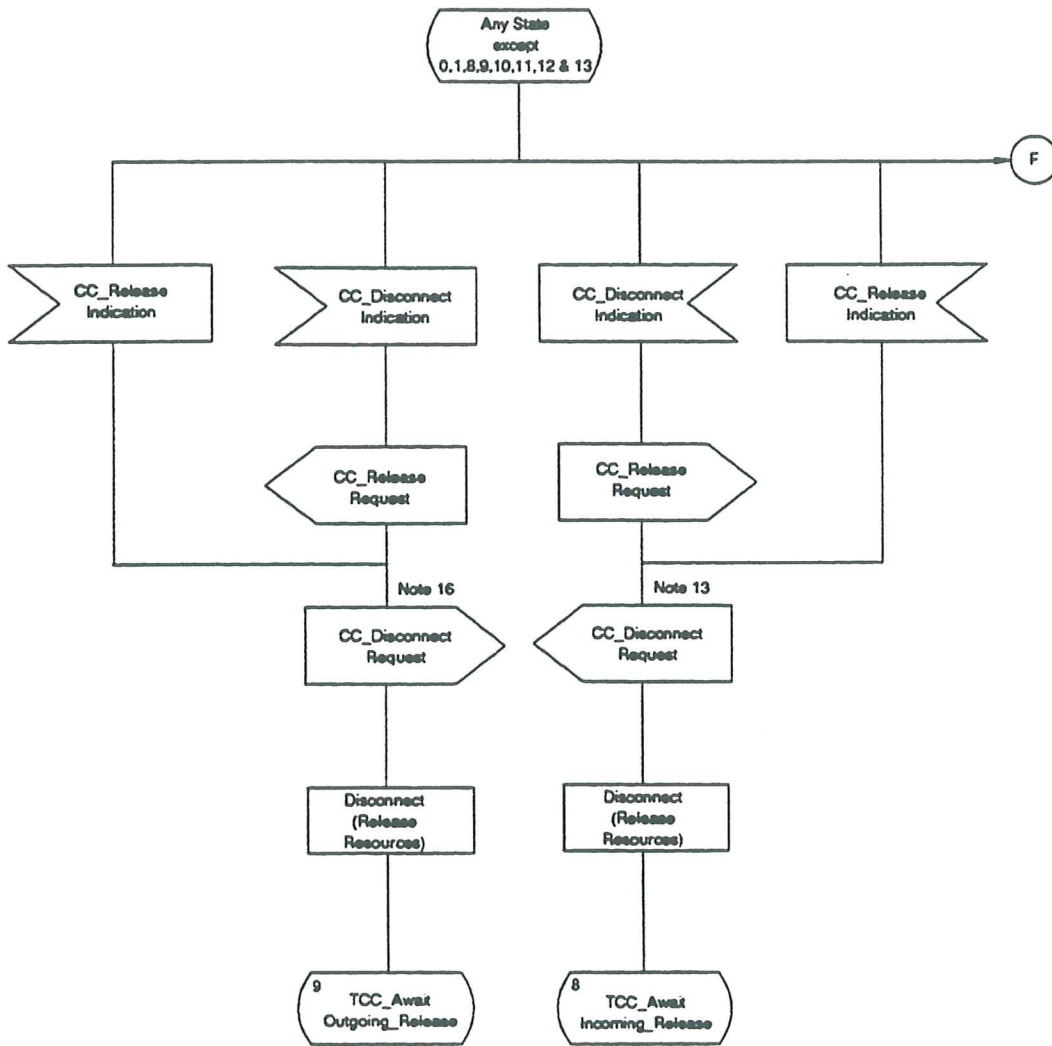

Figure 11 - Transit Call Control SDL Diagram (Part 13)

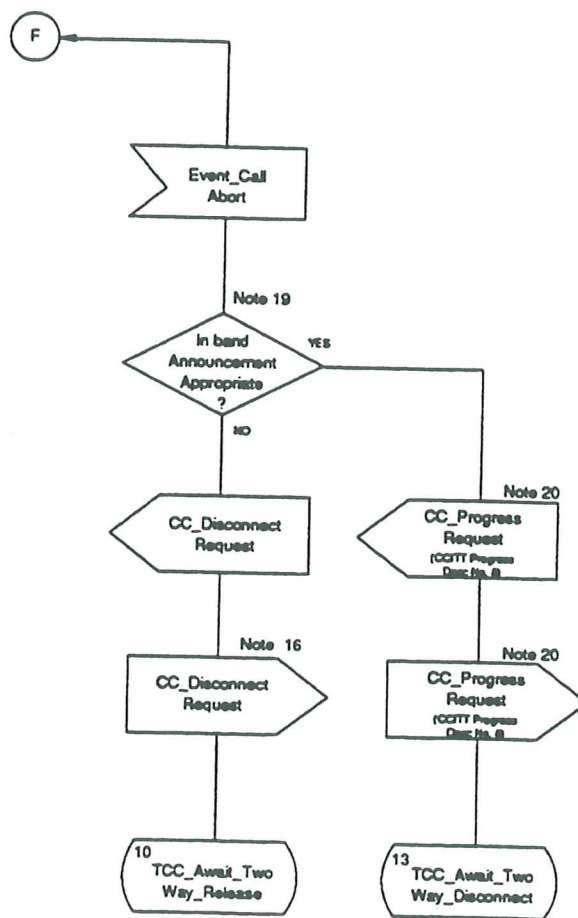

Figure 11 - Transit Call Control SDL Diagram (Part 14)

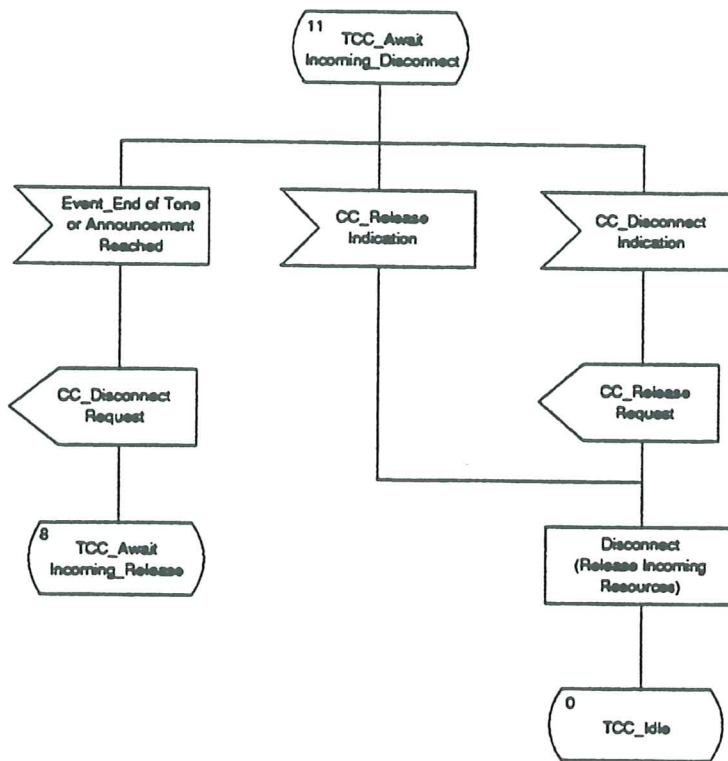

Figure 11 - Transit Call Control SDL Diagram (Part 15)

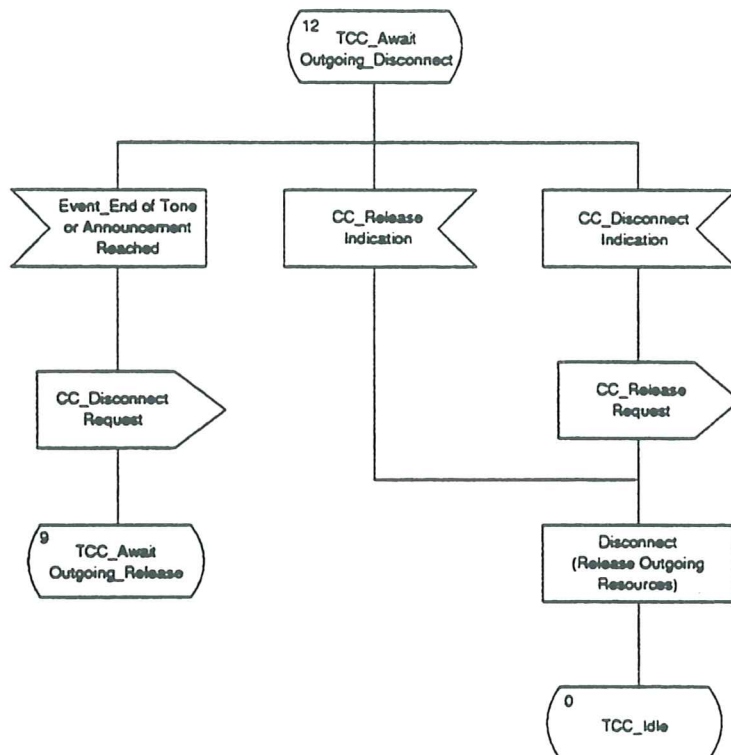

Figure 11 - Transit Call Control SDL Diagram (Part 16)



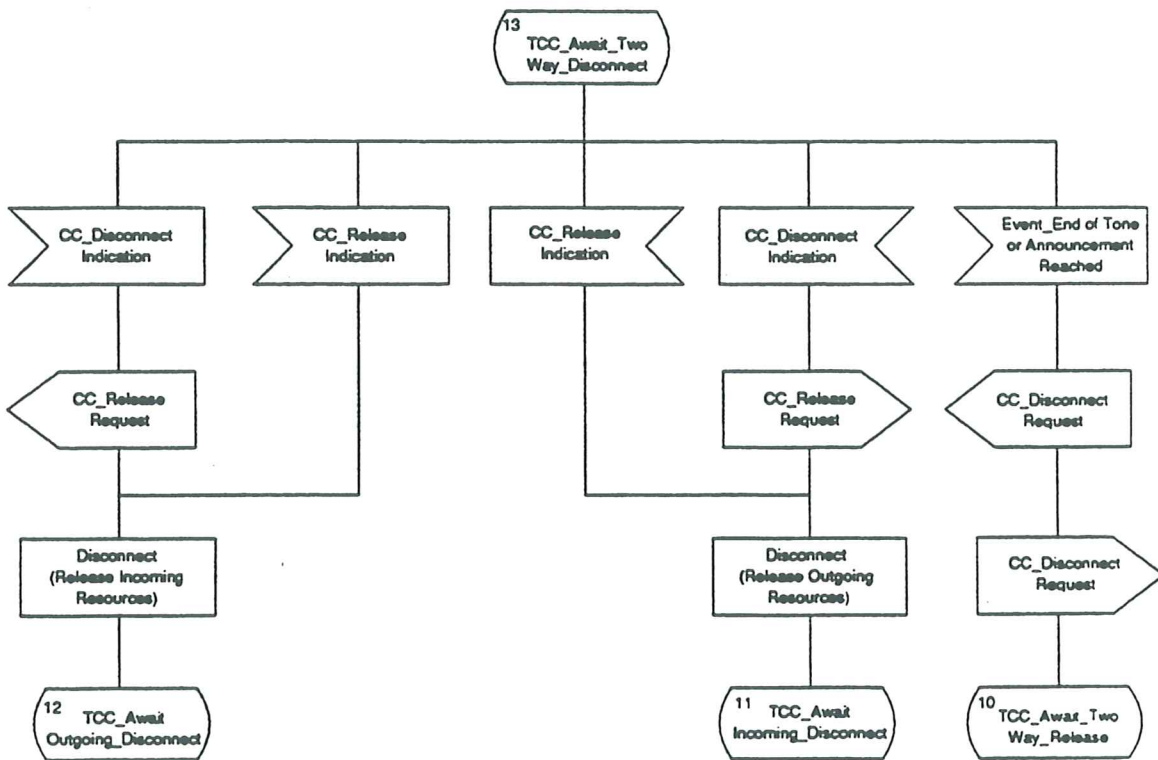

Figure 11 - Transit Call Control SDL Diagram (Part 17)

*Notes to Transit Call Control SDL Diagrams:*

**NOTE 12**

*This is the earliest point at which cut through of the B-channel - in either, or both directions - can occur, although it need not occur at this point.*

**NOTE 13**

*The action to be taken at this point is manufacturer specific (i.e. implementation dependant) and the sequence here is give for information only.*

**NOTE 14**

*T302 protocol timer started.*

**NOTE 15**

*This is the latest point at which cut through of the B-channel can occur.*

**NOTE 16**

*In state 2, Release Request is used.*

**NOTE 17**

*This request is only sent to the outgoing side Protocol Control if there has been information received from the incoming side Protocol Control which has been stored in an internal buffer.*

**NOTE 18**

*Cut through of the B-channel may occur at this point. If the received message contains CCITT progress description no. 1 or no. 8, the B-channel should be cut through in the Backward direction.*

**NOTE 19**

*The optional in-band tones or announcements on call clearing may be provided in both directions, or only one direction as an implementation decision. The SDL shows only the example where tones are provided in both directions and is not intended to preclude the clearing of the call in one direction and provision of the tone or announcement in the other. In addition, if the call is aborted in the active state, the Transit PTNX may optionally apply the tone or announcement without sending a PROGRESS message, as the B-channels are already through connected in the active state.*

**NOTE 20**

*The PROGRESS message (and tone or announcement) shall be applied in both directions only when the call is aborted in the active state.*

## **8.7 Originating PTNX Call Control Requirements**

This clause specifies requirements for Call Control at an Originating PTNX on the outgoing side of an inter-PTNX link. These requirements are additional to the Protocol Control procedures specified in 7, 8.1 to 8.4 and 10.

The following requirements apply when an Originating PTNX chooses to route a call over an inter-PTNX link and has selected a B-channel to be used.

Any reference to messages received shall be interpreted as meaning a message which has passed the validation checks of Protocol Control and which has therefore resulted in a notification being given to Call Control.

### **8.7.1 Transmission of the SETUP message**

The Originating PTNX shall transmit a SETUP message. The SETUP message shall include optional information elements according to the following rules.

- a) **Sending complete.** The Originating PTNX may optionally send this information element if it can determine that the Number in the Called party number information element is complete or if this has been indicated by the calling terminal.

- b) **Progress indicator.** The Originating PTNX shall pass on, by means of one or more Progress indicator information elements, progress information received from the calling user.  
  
The Originating PTNX may insert a Progress indicator information element containing CCITT progress description 3 (Origination address is non-ISDN) if neither the calling terminal nor the combination of the PTNX and the calling terminal has the functionality of an ISDN terminal.
- c) **Calling party number.** The Originating PTNX shall include the Calling party number information element identifying the calling user. The presentation indicator shall have the value "presentation restricted" if supplementary service Calling/Connected Line Identification Restriction (see ETS 300 173) has been invoked at the calling user. Otherwise the presentation indicator shall have the value "presentation allowed".
- d) **Calling party subaddress.** The Originating PTNX shall include the Calling party subaddress information element if a calling party subaddress has been supplied by the calling terminal.
- e) **Called party subaddress.** The Originating PTNX shall include the called party subaddress information element if a called party subaddress has been supplied by the calling user.
- f) **Low layer compatibility.** The Originating PTNX shall include the Low layer compatibility information element if low layer compatibility information has been supplied by the calling terminal.
- g) **High layer compatibility.** The Originating PTNX shall include the High layer compatibility information element if high layer compatibility information has been supplied by the calling terminal.
- h) **Transit counter.** The Transit counter information element may optionally be included as a means of preventing indefinite looping within the PTN. The value of the transit count field shall be zero.
- i) **Party category.** The Originating PTNX may optionally include the Party category information element to indicate the category of the calling party.

#### 8.7.2 Agreement of the B-channel

On receipt of a SETUP ACKNOWLEDGE, CALL PROCEEDING, ALERTING OR CONNECT message agreeing the channel proposed in the SETUP message or suggesting an alternative channel which the Originating PTNX finds acceptable, the Originating PTNX may optionally connect the B-channel in the forward direction, in the backward direction or in both directions.

##### NOTE 21

*It is recommended that the B-channel is connected in both directions at this stage, particularly for services involving the conveyance of speech information. Leaving the B-channel unconnected until a later stage, particularly in the backward direction, may lead to the "clipping" of speech. However, there may be reasons for delaying connection, particularly in the forward direction, e.g. to avoid the onward transmission of in-band signalling information from the user's access.*

#### 8.7.3 Receipt of progress indicators

Information received in a Progress indicator information element in a PROGRESS message, an ALERTING message or a CONNECT message may optionally be passed on to the calling user.

##### NOTE 22

*Certain information from a progress indicator information element may need to be stored within the Originating PTNX for use in the event of certain supplementary service invocations, e.g. call transfer.*

On receipt of a Progress indicator information element with CCITT progress description 8 (in-band information or appropriate pattern now available) or number 1 (call is not end-to-end ISDN, further call progress information may be available in-band) the Originating PTNX shall connect the B-channel in the backward direction if it has not already done so.

#### 8.7.4 Receipt of ALERTING Message

On receipt of an ALERTING message, an indication of alerting may be given to the calling user.

If the Party category presentation information element is included in the ALERTING message, the information therein may optionally be presented to the calling user.



Through connection may occur at this point. If the received message contains a Progress indicator information element with CCITT progress description 8 (in-band information or appropriate pattern now available) or number 1 (call is not end-to-end ISDN, further call progress information may be available in-band) the Originating PTNX shall connect the B-channel in the backward direction if it has not already done so.

#### 8.7.5 Receipt of CONNECT Message

On receipt of a CONNECT message, the Originating PTNX shall connect the B-channel in both directions, if it has not already done so, and shall indicate connection to the calling user.

If the CONNECT message contains a Low layer compatibility information element, and if the user is connected by means of an ISDN interface at the S reference point, the information element shall be conveyed to the calling user and the user may act upon the information therein. If the user is connected by means of a non-ISDN interface, conveyance of the information to the user depends on the user's ability to receive it.

If the CONNECT message contains a Connected number information element and/or a Connected subaddress information element, this information may be used for purposes such as the provision of the Connected Line Identification Presentation supplementary service to the calling user.

If the Party category presentation information element is included in the CONNECT message, the information therein may optionally be presented to the calling user.

#### 8.7.6 Call Clearing Initiated by the Originating PTNX

The Originating PTNX may initiate clearing if a clear request is received from the calling user or if a failure condition occurs. Clearing is initiated by informing Protocol Control and supplying a cause.

Alternatively, for services for which an in-band tone or announcement is appropriate, the Originating PTNX may connect an in-band tone or announcement to the outgoing B-channel and may optionally transmit a PROGRESS message containing a Progress indicator information element with CCITT progress description 8 (in-band information or appropriate pattern now available) and an appropriate cause. If an indication of clearing has not been received from Protocol Control by the time the tone or announcement is complete or has been applied for sufficient time, the Originating PTNX shall instruct Protocol Control to initiate clearing.

##### NOTE 23

*It is recommended that an in-band tone or announcement be provided by the Originating PTNX only if it conveys call failure information which is not conveyable by signalling.*

#### 8.7.7 Receipt of an Indication of Call Clearing

On receipt of an indication of call clearing from Protocol Control, the Originating PTNX shall either indicate to the calling user that the call has cleared or take some other implementation dependent action.

### 8.8 Terminating PTNX Call Control Requirements

This clause specifies requirements for Call Control at a Terminating PTNX on the incoming side of an inter-PTNX link. These requirements are additional to the Protocol Control procedures specified in 7, 8.1 to 8.4 and 10.

The following requirements apply when a PTNX receives a SETUP message, possibly followed by one or more INFORMATION messages conveying additional called party number information, and determines that the destination is a user on that PTNX. The PTNX therefore becomes a Terminating PTNX.

Any reference to messages received shall be interpreted as meaning a message which has passed the validation checks of Protocol Control and which has therefore resulted in a notification being given to Call Control.

#### 8.8.1 Receipt of the SETUP message

Information elements in the received SETUP message shall be used as follows.

- a) **Progress indicator.** If the SETUP message contains one or more Progress indicator information elements, the information therein may optionally be passed on to the called user.

##### NOTE 24

*Certain information from Progress indicator information elements may need to be stored within the Terminating PTNX for use in the event of certain supplementary service invocations, e.g. call transfer.*



- b) **Low layer compatibility, High layer compatibility and called party subaddress.** If the SETUP message contains one or more of these information elements, and if the user is connected by means of an ISDN interface at the S reference point, the information element(s) shall be conveyed to the called user and the user may act upon the information therein. If the user is connected by means of a non-ISDN interface, conveyance of the information to the user depends on the user's ability to receive it.
- c) **Calling party number and calling party subaddress.** Information in the Calling party number information element, and also in the optional Calling party subaddress information element, may be used for purposes such as the provision of the Calling Line Identification Presentation supplementary service to the called user.
- d) **Transit counter.** This information element shall be ignored.
- e) **If the Party category information element is included in the SETUP message,** the information therein may optionally be presented to the called user.

#### 8.8.2 **Transmission of ALERTING Message**

The Terminating PTNX shall transmit an ALERTING message when it is aware that the called user is being alerted.

For services which require an in-band tone or announcement to be supplied to the calling user during the period of alerting, the Terminating PTNX is responsible for connecting the appropriate tone or announcement to the B-channel in the backwards direction. If a tone or announcement is connected, the Terminating PTNX shall include a Progress indicator information element with CCITT progress description 8 (in-band information or appropriate pattern now available) in the ALERTING message.

Party category. The Terminating PTNX may optionally include the Party category information element to indicate the category of the called party.

#### 8.8.3 **Transmission of progress indicators**

The Terminating PTNX shall pass on, by means of one or more Progress indicator information elements, progress information received from the called user, either before or after the transmission of an ALERTING message.

The Terminating PTNX may send a Progress indicator information element containing CCITT progress description 2 (Destination address is non-ISDN) if neither the called terminal nor the combination of the PTNX and the called terminal has the functionality of an ISDN terminal.

A Progress indicator information element shall be transmitted in an ALERTING message or a CONNECT message if an ALERTING message or a CONNECT message is being sent at the time. Otherwise it shall be transmitted in a PROGRESS message.

#### 8.8.4 **Transmission of CONNECT Message**

When the Terminating PTNX is aware that the called user has answered, it shall connect the B-channel in both directions and send a CONNECT message. Any in-band tone or announcement shall be disconnected.

The Terminating PTNX shall include in the CONNECT message the Connected number information element identifying the party which has answered. The presentation indicator shall have the value "presentation restricted" if supplementary service Calling/Connected Line Identification Restriction (see ETS 300 173) has been invoked at the called user. Otherwise the presentation indicator shall have the value "presentation allowed".

The Terminating PTNX shall include in the CONNECT message the Connected subaddress information element if a connected party subaddress has been supplied by the called terminal.

The Terminating PTNX shall include in the CONNECT message the Low layer compatibility information element if low layer compatibility information has been supplied by the called terminal.

The Terminating PTNX may optionally include the Party category information element to indicate the category of the connected party.



#### 8.8.5 Call Clearing Initiated by the Terminating PTNX

The Terminating PTNX may initiate clearing if it is not able to proceed with call establishment, if a failure condition occurs after the call has been established, or if a clear request is received from the called user. Clearing is initiated by informing Protocol Control and supplying a cause.

Alternatively, for services for which an in-band tone or announcement is appropriate, the Terminating PTNX may connect an in-band tone or announcement to the incoming B-channel and transmit a PROGRESS message containing a Progress indicator information element with CCITT progress description 8 (in-band information or appropriate pattern now available) and an appropriate cause. If an indication of clearing has not been received from Protocol Control by the time the tone or announcement is complete or has been applied for sufficient time, the Terminating PTNX shall instruct Protocol Control to initiate clearing. The sending of the PROGRESS message is optional in the Active state but mandatory in other states.

##### NOTE 25

*It is recommended that an in-band tone or announcement be provided by the Terminating PTNX only if it conveys call rejection or failure information which is not conveyable by signalling.*

#### 8.8.6 Receipt of an Indication of Call Clearing

On receipt of an indication of call clearing from Protocol Control, the Terminating PTNX shall either indicate to the called user that the call has cleared or take some other implementation dependent action.

#### 8.9 Incoming Gateway PTNX Call Control Requirements

This clause specifies requirements for Call Control at an Incoming Gateway PTNX on the outgoing side of an inter-PTNX link . In particular, this clause applies to the case of interworking with the public ISDN using the Layer 3 protocol specified in ETS 300 102 at the T reference point. These requirements are additional to the Protocol Control procedures specified in 7, 8.1 to 8.4 and 10.

The following requirements apply when a call entering the PTN is routed, by the Incoming Gateway PTNX, over an inter-PTNX link , a B-channel on that link having been selected.

Any reference to messages received shall be interpreted as meaning a message which has passed the validation checks of Protocol Control and which has therefore resulted in a notification being given to Call Control.

##### 8.9.1 Transmission of the SETUP message

The Incoming Gateway PTNX shall transmit a SETUP message. The SETUP message shall include optional information elements according to the following rules.

- a) **Sending complete.** The Incoming Gateway PTNX may optionally send this information element if it can determine that the Number in the Called party number information element is complete or if this has been indicated by the other network.
- b) **Progress indicator.** The inclusion of Progress indicator information elements by the Incoming Gateway PTNX shall be in accordance with 8.9.2.
- c) **Calling party number.** If the other network has supplied a calling party number with or without an indication that presentation is restricted or a restriction indication only, the Incoming Gateway PTNX shall include this information in the SETUP message within the Calling party number information element. Otherwise the Calling party number information element shall either contain the presentation indicator value "number not available due to interworking" or be omitted.
- d) **Calling party subaddress.** If the other network is a public ISDN and supplies a Calling party subaddress information element, the Incoming Gateway PTNX shall pass the information element on unchanged in the SETUP message. The Incoming Gateway PTNX may also include a Calling party subaddress information element in the SETUP message if calling party subaddress information has been supplied by a non-ISDN.
- e) **Called party subaddress.** If the other network is a public ISDN and supplies a Called party subaddress information element, the Incoming Gateway PTNX shall pass the information element on unchanged in the SETUP message. The Incoming Gateway PTNX may also include a Called party subaddress



information element in the SETUP message if called party subaddress information has been supplied by a non-ISDN.

- f) **Low layer compatibility.** If the other network is a public ISDN and supplies a Low layer compatibility information element, the Incoming Gateway PTNX shall pass the information element on unchanged in the SETUP message. The Incoming Gateway PTNX may also include a Low layer compatibility information element in the SETUP message if low layer compatibility information has been supplied by a non-ISDN.
- g) **High layer compatibility.** If the other network is a public ISDN and supplies a High layer compatibility information element, the Incoming Gateway PTNX shall pass the information element on unchanged in the SETUP message. The Incoming Gateway PTNX may also include a High layer compatibility information element in the SETUP message if high layer compatibility information has been supplied by a non-ISDN.
- h) **Transit counter.** The Transit counter information element may optionally be included as a means of preventing indefinite looping within the PTN. The value of the transit count field shall be zero.
- i) **Party category .** The Incoming Gateway PTNX may optionally include the Party category information element to indicate the category of the calling party. Unless information has been supplied by the other network, the value 0 "unknown" shall be used.

## 8.9.2 Interworking Indications in the SETUP Message

The inclusion of the Progress indicator information element in the SETUP message shall be as specified below. If none of the specified conditions apply, no Progress indicator information element shall be included. If more than one of the specified conditions apply, the Progress indicator information element shall be repeated in order to indicate all applicable conditions.

### 8.9.2.1 Interworking Indications Received from a Public ISDN

If the call has arrived from a public ISDN and a Progress indicator information element containing one of the following CCITT progress descriptions has been received from the public ISDN, that information element shall be passed on:

- 1 "call is not end-to-end ISDN, further call progress information may be available in-band";
- 3 "origination address is non-ISDN".

### 8.9.2.2 Interworking with a Public Network

If the call has entered the PTN from a public network (ISDN or non-ISDN), a Progress indicator information element shall be sent containing ECMA progress description 16 "call is routed via a public network".

### 8.9.2.3 Interworking with another Private Network

If the call has entered the PTN from another private network (ISDN or non-ISDN), a Progress indicator information element may be sent containing ECMA progress description 20 "call is routed via another private network".

### 8.9.2.4 Interworking with a Non-ISDN

If the call has entered the PTN from a network (public or private) which is not ISDN, a Progress information element may be sent containing CCITT progress description 1 "call is not end-to-end ISDN, further call progress information may be available in-band".

### 8.9.2.5 Interworking with a Network with Limited Release Capability

If the call has entered the PTN from a network which is unable, or not always able, to supply to the PTN an indication that the call has been released, a Progress information element shall be sent containing one of the following ECMA progress descriptions:

- 17 "interworking with a network unable to supply a release signal"
- 18 "interworking with a network unable to supply a release signal before answer"
- 19 "interworking with a network unable to supply a release signal after answer".

Progress description 18 shall be used if the other network is able to indicate release after it has received an answer signal from the PTN, but is not always able to indicate release prior to receiving an answer signal. In this case, the other network relies on receiving a release signal from the PTN if answer does not occur within a reasonable time.

Progress description 19 shall be used if the other network is able to indicate release prior to the receipt of an answer signal from the PTN, but is not always able to indicate release after receiving an answer signal. In this case, the other network relies on receiving a release signal from the PTN when release is initiated by the called party.

Progress description 17 shall be used if the other network is not always able to indicate release prior to answer and is not always able to indicate release after answer. In this case, the other network relies on receiving a release signal from the PTN if answer does not occur within a reasonable time and when release is initiated by the called party.

### 8.9.3 Agreement of the B-channel

On receipt of a SETUP ACKNOWLEDGE, CALL PROCEEDING, ALERTING or CONNECT message agreeing the channel proposed in the SETUP message or suggesting an alternative channel which the Incoming Gateway PTNX finds acceptable, the Incoming Gateway PTNX may optionally connect the B-channel in the forward direction, in the backward direction or in both directions.

#### NOTE 26

*It is recommended that the B-channel is connected in both directions at this stage, particularly for services involving the conveyance of speech information. Leaving the connection until a later stage, particularly in the backward direction, may lead to the "clipping" of speech. However, there may be reasons for delaying connection, particularly in the forward direction, e.g. to avoid the onward transmission of in-band signalling information from the other network.*

### 8.9.4 Receipt of progress indicators

Information received in a Progress indicator information element in a PROGRESS message, an ALERTING message or a CONNECT message may optionally be passed on to the other network if the signalling system permits and if relevant.

#### NOTE 27

*Certain information from a Progress indicator information element may need to be stored within the Incoming Gateway PTNX for use in the event of certain supplementary service invocations, e.g. call transfer.*

On receipt of a Progress indicator information element with CCITT progress description 8 (in-band information or appropriate pattern now available) or number 1 (call is not end-to-end ISDN, further call progress information may be available in-band) the Incoming Gateway PTNX shall connect the B-channel in the backward direction if it has not already done so.

### 8.9.5 Receipt of ALERTING Message

On receipt of an ALERTING message, an indication of alerting may be given to the other network if the signalling system permits.

If the Party category information element is included in the ALERTING message, the information therein may optionally be conveyed to the other network if the signalling system permits.

If the ALERTING message contains a Progress indicator information element with CCITT progress description 8 (in-band information or appropriate pattern now available) or number 1 (call is not end-to-end ISDN, further call progress information may be available in-band) the Incoming Gateway PTNX shall connect the B-channel in the backward direction if it has not already done so.

### 8.9.6 Receipt of CONNECT Message

On receipt of a CONNECT message, the Incoming Gateway PTNX shall connect the B-channel in both directions, if it has not already done so, and shall indicate connection to the other network if the signalling system permits.



If the CONNECT message contains a Low layer compatibility information element, the information element shall be conveyed unchanged to the other network if that network is a public ISDN. Where the other network is non-ISDN, low layer compatibility information may be conveyed to the other network if the signalling system permits.

If the CONNECT message contains a Connected number information element, conveyance of the information therein to the other network depends on the capability of the signalling system and whether the connected party number has significance in the other network. Translation of a number into the numbering plan of the other network may be performed in order to yield a number which has significance in the other network.

If the CONNECT message contains a Connected subaddress information element, the information element shall be conveyed unchanged to the other network if that network is a public ISDN. Where the other network is non-ISDN, connected party subaddress information may be conveyed to the other network if the signalling system permits.

If the received Connected number information element has the presentation indicator value "presentation restricted", presentation of the number to the other network is outside the scope of this Standard but will depend on such factors as the other network's commitment to honour the restriction.

If the Party category information element is included in the CONNECT message, the information therein may optionally be conveyed to the other network if the signalling system permits.

#### **8.9.7 Call Clearing Initiated by the Incoming Gateway PTNX**

The Incoming Gateway PTNX may initiate clearing if a clear request is received from other network or if a failure condition occurs. Clearing is initiated by informing Protocol Control and supplying a cause.

Alternatively, for services for which an in-band tone or announcement is appropriate, the Incoming Gateway PTNX may connect an in-band tone or announcement to the outgoing B-channel and may optionally transmit a PROGRESS message containing a Progress indicator information element with CCITT progress description 8 (in-band information or appropriate pattern now available) and an appropriate cause. A PROGRESS message containing a Progress indicator information element with CCITT progress description 8 may also be sent in cases where the other network indicates that it is providing an in-band tone or announcement in preparation for clearing. If an indication of clearing has not been received from Protocol Control by the time the tone or announcement is complete or has been applied for sufficient time, the Incoming Gateway PTNX shall instruct Protocol Control to initiate clearing.

#### *NOTE 28*

*It is recommended that an in-band tone or announcement be provided by the Incoming Gateway PTNX only if it conveys call failure information which is not conveyable by signalling.*

#### **8.9.8 Receipt of an Indication of Call Clearing**

On receipt of an indication of call clearing from Protocol Control, the Incoming Gateway PTNX shall either indicate to the other network that the call has cleared or take some other implementation dependent action.

#### **8.10 Outgoing Gateway PTNX Call Control Requirements**

This clause specifies requirements for Call Control at an Outgoing Gateway PTNX on the incoming side of an inter-PTNX link. In particular, this clause applies to the case of interworking with the public ISDN using the Layer 3 protocol specified in ETS 300 102 at the T reference point. These requirements are additional to the Protocol Control procedures specified in 7, 8.1 to 8.4 and 10.

The following requirements apply when a PTNX receives a SETUP message, possibly followed by one or more INFORMATION messages conveying additional called party number information, and determines that the call is to be routed directly (not via any further PTNX) to another network. The PTNX therefore becomes an Outgoing Gateway PTNX.

Any reference to messages received shall be interpreted as meaning a message which has passed the validation checks of Protocol Control and which has therefore resulted in a notification being given to Call Control.

##### **8.10.1 Receipt of the SETUP message**

information elements in the received SETUP message shall be used as follows.



- a) **Progress indicator.** If the SETUP message contains one or more Progress indicator information elements, the information therein may optionally be passed on to the other network if the signalling system permits and if relevant.
- b) Certain information from Progress indicator information elements may affect the decision of the Outgoing Gateway PTNX to route the call to another network. In particular, the Outgoing Gateway PTNX shall not establish a call which cannot be released, as determined by the presence of a Progress indicator information element containing ECMA progress description 17, 18 or 19 and the Outgoing Gateway PTNX's knowledge of the ability of the other network to signal release.

**NOTE 29**

*Certain information from Progress indicator information elements may need to be stored within the Outgoing Gateway PTNX for use in the event of certain supplementary service invocations, e.g. call transfer.*

- c) **Low layer compatibility, High layer compatibility, called party subaddress and Calling party subaddress.** If the SETUP message contains one or more of these information elements, the information element(s) shall be conveyed unchanged to the other network if that network is a public ISDN. Where the other network is non-ISDN, information from these elements may be conveyed to the other network if the signalling system permits. However, the Calling party subaddress information element shall not be sent to the network if the presentation indicator in the received Calling party number information element has the value "presentation restricted".
- d) **Calling party number.** If the SETUP message contains a Calling party number information element, conveyance of the information therein to the other network depends on the capability of the signalling system and whether the calling party number has significance in the other network. Translation of a number into the numbering plan of the other network may be performed in order to yield a number which has significance in the other network. If the received Calling party number information element has the presentation indicator value "presentation restricted", presentation of the number to the other network is outside the scope of this Standard but will depend on such factors as the other network's commitment to honour the restriction.
- e) **Transit counter.** This information element shall be ignored.
- f) If the **Party category** information element is included in the SETUP message, the information therein may optionally be conveyed to the other network if the signalling system permits.

**8.10.2 Connection of the B-channel**

The Outgoing Gateway PTNX may optionally connect the B-channel in the forward direction, in the backward direction or in both directions as soon as the channel to the other network has been agreed.

**NOTE 30**

*It is recommended that the B-channel is connected in both directions at this stage, particularly for services involving the conveyance of speech information. Leaving the B-channel unconnected until a later stage, particularly in the backward direction, may lead to the "clipping" of speech or the loss of in-band tones or announcements. However, there may be reasons for delaying connection, particularly in the forward direction, e.g. while transmitting in-band signalling information.*

**8.10.3 Transmission of Interworking Indications**

The Outgoing Gateway PTNX shall transmit Progress indicator information elements as specified below. A Progress indicator information element shall be transmitted in a PROGRESS message, an ALERTING message or a CONNECT message as soon as the information becomes available, subject to a SETUP ACKNOWLEDGE or CALL PROCEEDING message having already been sent. A PROGRESS message shall be used unless an ALERTING or CONNECT message is to be sent at the time. All appropriate interworking indications shall be transmitted by the Outgoing Gateway PTNX, by repeating the Progress indicator information element in a message if necessary.



#### **8.10.3.1 Interworking Indications Received from a Public ISDN**

If the call has entered a public ISDN and a Progress indicator information element containing one of the following CCITT progress descriptions has been received from the public ISDN, that information element shall be passed on:

- 1 "call is not end-to-end ISDN, further call progress information may be available in-band";
- 2 "destination address is non-ISDN";
- 4 "call has returned to the ISDN";
- 8 "in-band information or appropriate pattern now available".

In the case of progress descriptions 1 and 8, the Outgoing Gateway PTNX shall connect the B-channel in the backward direction if it has not already done so.

#### **8.10.3.2 Interworking with a Public Network**

If the call is to enter a public network (ISDN or non-ISDN), a Progress indicator information element shall be sent containing ECMA progress description 16 "call is routed via a public network".

#### **8.10.3.3 Interworking with another Private Network**

If the call is to enter another private network (ISDN or non-ISDN), a Progress indicator information element may be sent containing ECMA progress description 20 "call is routed via another private network".

#### **8.10.3.4 Interworking with a Non-ISDN**

If the call is to enter a network (public or private) which is not ISDN, a Progress information element may be sent containing CCITT progress description 1 "call is not end-to-end ISDN, further call progress information may be available in-band". The Outgoing Gateway PTNX shall connect the B-channel in the backward direction if it has not already done so.

#### **8.10.3.5 Interworking with a Network with Limited Release Capability**

If the call is to enter a network which is unable, or not always able, to supply to the PTN an indication that the call has been released, a Progress information element shall be sent containing one of the following ECMA progress descriptions:

- 17 "interworking with a network unable to supply a release signal";
- 18 "interworking with a network unable to supply a release signal before answer";
- 19 "interworking with a network unable to supply a release signal after answer".

Progress description 18 shall be used if the other network is able to indicate release after it has sent an answer signal to the PTN, but is not always able to indicate release in the event of no reply. The other network relies on receiving a release signal from the PTN when release is initiated by the calling party or if answer does not occur within a reasonable time.

Progress description 19 shall be used if the other network is able to indicate release prior to the sending an answer signal to the PTN, but is not always able to indicate release after sending an answer signal. In this case, the other network relies on receiving a release signal from the PTN when release is initiated by the calling party.

Progress description 17 shall be used if the other network is not always able to indicate release prior to answer and is not always able to indicate release after answer. In this case, the other network relies on receiving a release signal from the PTN if answer does not occur within a reasonable time and when release is initiated by the calling party.

#### **8.10.4 Transmission of ALERTING Message**

The Outgoing Gateway PTNX shall transmit an ALERTING message when it receives an indication from the other network that the called user is being alerted. Some other networks may be unable to indicate alerting.

For services which require an in-band tone or announcement to be supplied to the calling user during the period of alerting, the Outgoing Gateway PTNX is responsible for connecting the appropriate tone or announcement to the B-channel in the backwards direction, unless an appropriate tone or announcement is being provided by the



other network. If a tone or announcement is being provided either by the Outgoing Gateway PTNX or by the other network, the Outgoing Gateway PTNX shall include a Progress indicator information element with CCITT progress description 8 (in-band information or appropriate pattern now available) in the ALERTING message.

The Outgoing Gateway PTNX may optionally include the Party category information element to indicate the category of the called party. Unless information has been supplied by the other network, the value 0 "unknown" shall be used.

#### **8.10.5 Transmission of CONNECT Message**

When the Outgoing Gateway PTNX receives an answer signal from the other network, it shall connect the B-channel in both directions, if it has not already done so, and send a CONNECT message.

If the other network is not always able to supply an answer signal, the Outgoing Gateway PTNX shall connect the B-channel in both directions and send a CONNECT message when a suitable time interval has elapsed following the sending of call information to the other network. The time interval chosen should take account of the shortest likely time to answer. If, subsequent to sending a CONNECT message, an answer signal is received from the other network, the Outgoing Gateway PTNX shall not send a second CONNECT message.

If the other network has supplied a connected party number with or without an indication that presentation is restricted or a restriction indication only, the Outgoing Gateway PTNX shall include this information in the CONNECT message within the Connected number information element. Otherwise the Connected number information element shall either contain the presentation indicator value "number not available due to interworking" or be omitted.

If the other network is a public ISDN and supplies a Connected subaddress information element, the Outgoing Gateway PTNX shall pass the information element unchanged in the CONNECT message. The Outgoing Gateway PTNX may also include a Connected subaddress information element in the CONNECT message if connected party subaddress information has been supplied by a non-ISDN.

If the other network is a public ISDN and supplies a Low layer compatibility information element, the Outgoing Gateway PTNX shall pass the information element unchanged in the CONNECT message. The Outgoing Gateway PTNX may also include a Low layer compatibility information element in the CONNECT message if low layer compatibility information has been supplied by a non-ISDN.

The Outgoing Gateway PTNX may optionally include the Party category information element to indicate the category of the connected party. Unless information has been supplied by the other network, the value 0 "unknown" shall be used.

#### **8.10.6 Call Clearing Initiated by the Outgoing Gateway PTNX**

The Outgoing Gateway PTNX may initiate clearing if it is not able to proceed with call establishment, if a failure condition occurs after the call has been established, or if a clear request is received from the other network. Clearing is initiated by informing Protocol Control and supplying a cause.

Alternatively, for services for which an in-band tone or announcement is appropriate, the Outgoing Gateway PTNX may connect an in-band tone or announcement to the incoming B-channel and may optionally transmit a PROGRESS message containing a Progress indicator information element with CCITT progress description 8 (in-band information or appropriate pattern now available) and an appropriate cause. A PROGRESS message containing a Progress indicator information element with CCITT progress description 8 may also be sent in cases where the other network indicates that it is providing an in-band tone or announcement in preparation for clearing. If an indication of clearing has not been received from Protocol Control by the time the tone or announcement is complete or has been applied for sufficient time, the Outgoing Gateway PTNX shall instruct Protocol Control to initiate clearing. The sending of the PROGRESS message is optional in the Active state but mandatory in other states.

#### *NOTE 31*

*It is recommended that an in-band tone or announcement be provided by the Outgoing Gateway PTNX only if it conveys call rejection or failure information which is not conveyable by signalling.*



### 8.10.7 Receipt of an Indication of Call Clearing

On receipt of an indication of call clearing from Protocol Control, the Outgoing Gateway PTNX shall either indicate to the other network that the call has cleared or take some other implementation dependent action.

## 9 Procedures For Layer Management

### 9.1 Restart Procedures

The restart procedure may be used to return a single channel, or all channels associated with the D-channel, to the idle condition and calls associated with these channels to the Null state. The procedure may be invoked when the adjacent PTNX does not respond to call control messages or a failure has occurred (e.g. following a Data Link failure; or following the second expiry of timer T308 due to the absence of response to a clearing message).

#### 9.1.1 Sending RESTART

A RESTART message may be sent by either side in order to return a channel or all channels associated with the D-channel to the idle state. The Channel identification information element shall be present in the RESTART message when a specified channel is to be returned to the idle condition. Absence of the Channel identification information element indicates that all channels associated with the D-channel are to be restarted.

Upon transmitting the RESTART message the sending entity shall enter the Restart Request state, starts timer T316, and waits for a RESTART ACKNOWLEDGE message. No further RESTART messages shall be sent until a RESTART ACKNOWLEDGE message is received or timer T316 expires.

Receipt of a RESTART ACKNOWLEDGE message shall stop timer T316, free the channels and call reference values (associated with the channels identified by the RESTART message) for reuse, and cause the receiving entity to enter the Null state.

If a RESTART ACKNOWLEDGE message is not received prior to expiry of timer T316 one or more subsequent RESTART messages may be sent until a RESTART ACKNOWLEDGE message is returned - the limit of the number of times RESTART may be sent is implementation dependant.

Meanwhile, no calls shall be placed or accepted on the channels identified in the RESTART message by the originator of the message. When the limit for the number of restarts is reached, the originator shall make no further restart attempts. An indication shall be provided to the appropriate maintenance entity. The channels identified shall be considered to be in an out-of-service condition until maintenance action has been taken.

The RESTART and RESTART ACKNOWLEDGE messages shall contain the global call reference value with which the Restart Request state is associated.

#### 9.1.2 Receipt of RESTART

Upon receiving a RESTART message the recipient shall enter the Restart state associated with the global call reference. It shall then initiate the appropriate internal actions to return the specified channels to the idle condition and call reference(s) to the Null state. Upon completion of internal clearing a RESTART ACKNOWLEDGE message shall be transmitted to the originator, and the transmitting entity shall enter the Null state.

#### 9.1.3 Restart Collision

Restart collision occurs at an interface when both sides of the system interface simultaneously transmit a RESTART message. The recipient of a RESTART message whilst in the Restart Request state associated with the Global Call reference, shall send a RESTART ACKNOWLEDGE, cancel timer T316, free the channels and call reference values (associated with the channels identified by the RESTART message) for reuse and enter the Null state.

## 10 Protocol Timers

All timer values given in this table have a tolerance of 10%.

**Table 6 - Protocol Timer definitions (Part 1)**

Timer Number	Timer Value	Call State	Cause for Start	Normally terminated	Action To Be Taken When Timer Expires	Incoming side	Outgoing side
T301	NOTE 35	Call Delivered	ALERTING received	On CONNECT received	Clear Call as specified in 8.1.5		O
T302	Minimum 14 s Maximum 16 s	Overlap Receiving	Sending of SETUP ACKNOWLEDGE Restart on receipt of INFORMATION message	On the sending of CALL PROCEEDING, ALERTING or CONNECT	Clear Call if information is definitely incomplete (as specified in 8.1.4.2) else send CALL PROCEEDING	M	
T303	Minimum 4 s Maximum 6 s	Call Initiated	On Sending SETUP	On receipt of CALL PROCEEDING, CONNECT, ALERTING, SETUP ACKNOWLEDGE or RELEASE COMPLETE	Retransmit SETUP and restart T303 or clear the call as specified in 8.1.1		M
Second T303	Minimum 4 s Maximum 6 s	Call Initiated	On retransmission of SETUP	On receipt of CALL PROCEEDING, CONNECT, ALERTING, SETUP ACKNOWLEDGE or RELEASE COMPLETE	Clear call as specified in 8.1.1		O
T304	Minimum 20 s	Overlap sending	SETUP ACK. received; sending of INFORMATION restarts T304	Receiving CALL PROCEEDING, ALERTING, CONNECT or DISCONNECT	Clear the call using procedures specified in 8.1.3		M
T305	Minimum 4 s Maximum 30 s	Disconnect Request	On Sending DISCONNECT	Receipt of RELEASE or DISCONNECT	Send RELEASE, start T308	M	M
T308	Minimum 4 s Maximum 6 s	Release Request	On Sending RELEASE	On receiving RELEASE or RELEASE COMPLETE	Retransmit RELEASE, restart T308	M	M
Second T308	Minimum 4 s Maximum 6 s	Release Request	On Retransmission of RELEASE	On Receiving RELEASE or RELEASE COMPLETE	Release Call Reference; place B-channel in maintenance condition (optionally initiate RESTART procedures)	M	M
T309	90 s	Any state	Data link disconnection. Calls in Stable states are not lost	On Data Link re-establishment	Clear connection, release call reference and B-channel	M	M
T310	Minimum 110 s Maximum 120 s	Outgoing Call Proceeding	On receipt of CALL PROCEEDING	On Receipt of ALERTING, CONNECT, PROGRESS (#1, #2 or #8), DISCONNECT or RELEASE	Clear the call as specified in 8.1.4.3		M (Opt for a Transit Node)
T313	Minimum 4 s Maximum 6 s	Connect Request	On sending CONNECT	On Receipt of CONNECT ACKNOWLEDGE	Clear the call as specified in 8.1.6	O	



**Table 6 - Protocol Timer definitions (Part 2)**

Timer Number	Timer Value	Call State	Cause for Start	Normally terminated	Action To Be Taken When Timer Expires	Incoming side	Outgoing side
T314	Minimum 4 s Maximum 6 s	Receiving segmented message	Message segment received	Last message segment received	Discard Message	M(I)	M(I)
T316	120 s	Restart Request	On sending of RESTART	On Receipt of RESTART ACKNOWLEDGE	Retransmit RESTART, restart T316	M	M
Final T316	120 s	Restart Request	On Final retransmission of RESTART	On Receipt of RESTART ACKNOWLEDGE	Notify maintenance: "Channel/Interface out of service"	M	M
T322	Minimum 4 s Maximum 6 s	Any call state except null	STATUS ENQUIRY sent	STATUS, DISCONNECT, RELEASE or RELEASE COMPLETE received	STATUS ENQUIRY may be transmitted several times - implementation dependant	M(I)	M(I)

Legend to table 6, columns 7 and 8:

M → The timer is mandatory

O → The timer is optional

M(I) → The timer is mandatory if the associated procedures are implemented

*Notes to table 6:*

**NOTE 32**

*All protocol Timers, except T314 and T316, if running, should be terminated on entering the null state.*

**NOTE 33**

*The number of times T316 is restarted is an implementation option.*

**NOTE 34**

*Timers T301, T302, T303, T304, T310 and T313 are all stopped (if running) on receipt or transmission of any clearing message.*

**NOTE 35**

*The value of optional timer T301 is implementation dependent and is not specified as part of this Standard.*

### Section III - Messages

#### 11 Functional Definition and Content of Messages

This chapter provides an overview of the structure of messages and defines the function and information contents (i.e. semantics) of each message.

Whenever a message is sent, according to the procedures of clauses 7, 8 and 9, it shall contain the mandatory information elements, and optionally any combination of the optional information elements, specified in this clause for that message.

Each definition includes:

- a) A brief description of the message direction and use.
- b) A table listing the information elements of codeset 0 and codeset 5 in the order of their appearance in the message (same relative order for all message types). However, the shift element which effects the shift from codeset 0 to codeset 5 is not shown explicitly in the tables.
- c) Indications for each information element in the table, specifying:
  - the clause of this Standard describing the information element;
  - whether inclusion is mandatory ('M') or optional ('O');
  - the length (or length range) of the information element, where '\*' denotes an undefined maximum length which may be network or service dependent. Note that certain optional information elements may be present in the message, but empty (length= 2 octets), but this case is not considered in the tables.
- d) Further explanatory notes, as necessary.

The significance of each message is defined for every possible use in the relevant stage 2 and 3 descriptions of call control procedures.

Other messages and information elements may be required for the support of supplementary services and additional network features (ANF's); these will be defined in other standards.

Unless otherwise qualified by an individual note, information elements marked as optional in the definition of a message should be included whenever the sender is able to provide the information (i.e. the information is available at the sending side of a link), if it has not been sent before.

#### 11.1 Messages for General Procedures

##### 11.1.1 STATUS

This message is sent by either side in response to a STATUS ENQUIRY message or at any time during a call to report certain error conditions.

**Table 7 - STATUS Message Content**

Message type: STATUS

Direction: both

information element	Reference	Type	Length
Protocol discriminator	12.2	M	1
Call reference	12.3	M (note 36)	3
Message type	12.4	M	1
Cause	12.5	M	4 - 32
Call state	12.5	M	3

**NOTE 36**

*This message may be sent with the global call reference.*

**11.1.2 STATUS ENQUIRY**

This message may be sent by either side at any time to solicit a STATUS message from the peer layer 3 entity.

**Table 8 - STATUS ENQUIRY Message Content**

Message type: STATUS ENQUIRY

Direction: both

information element	Reference	Type	Length
Protocol discriminator	12.2	M	1
Call reference	12.3	M	3
Message type	12.4	M	1

**11.2 Messages for Circuit Mode Call Control**

**11.2.1 ALERTING**

This message is sent by the incoming side to the outgoing side to indicate that called user alerting has been initiated.

**Table 9 - ALERTING Message Content**

Message type: ALERTING

Direction: incoming to outgoing

information element	Reference	Type	Length
Protocol discriminator	12.2	M	1
Call reference	12.3	M	3
Message type	12.4	M	1
Channel identification	12.5	O (note 37)	4 - *
Progress indicator	12.5	O (note 38)	4
Party category	12.6	O	3

**NOTE 37**

*Mandatory if ALERTING is the first response to a SETUP message, otherwise it should be omitted.*

**NOTE 38**

*May be repeated.*



### 11.2.2 CALL PROCEEDING

This message is sent by the incoming side to indicate that the requested call establishment has been initiated and no more call establishment information will be accepted.

**Table 10 - CALL PROCEEDING Message Content**

Message type: CALL PROCEEDING

Direction: incoming to outgoing

information element	Reference	Type	Length
Protocol discriminator	12.2	M	1
Call reference	12.3	M	3
Message type	12.4	M	1
Channel identification	12.5	O (note 39)	4 - *

NOTE 39

Mandatory if CALL PROCEEDING is the first response to a SETUP message, otherwise it should be omitted.

### 11.2.3 CONNECT

This message is sent by the incoming side to the outgoing side to indicate call acceptance by the called user.

**Table 11 - CONNECT Message Content**

Message type: CONNECT

Direction: incoming to outgoing

information element	Reference	Type	Length
Protocol discriminator	12.2	M	1
Call reference	12.3	M	3
Message type	12.4	M	1
Channel identification	12.5	O (note 40)	4 - *
Progress indicator	12.5	O (note 41)	4
Connected number	12.5	O	4 - *
Connected subaddress	12.5	O	4 - 23
Low layer compatibility	12.5	O	4 - 16
Party category	12.6	O	3

NOTE 40

Mandatory if CONNECT is the first response to a SETUP message, otherwise it should be omitted.

NOTE 41

May be repeated.

#### 11.2.4 CONNECT ACKNOWLEDGE

This message is sent by the outgoing side to acknowledge the receipt of a CONNECT message.

**Table 12 - CONNECT ACKNOWLEDGE Message Content**

Message type: CONNECT ACKNOWLEDGE

Direction: outgoing to incoming

information element	Reference	Type	Length
Protocol discriminator	12.2	M	1
Call reference	12.3	M	3
Message type	12.4	M	1

#### 11.2.5 DISCONNECT

This message is sent by either side as an invitation to terminate the connection.

**Table 13 - DISCONNECT Message Content**

Message type: DISCONNECT

Direction: both

information element	Reference	Type	Length
Protocol discriminator	12.2	M	1
Call reference	12.3	M	3
Message type	12.4	M	1
Cause	12.5	M	4 - 32

#### 11.2.6 INFORMATION

This message is sent by the outgoing side to provide additional information during call establishment (in the case of overlap sending).

**Table 14 - INFORMATION Message Content**

Message type: INFORMATION

Direction: outgoing to incoming

information element	Reference	Type	Length
Protocol discriminator	12.2	M	1
Call reference	12.3	M	3
Message type	12.4	M	1
Sending complete	12.5	O (note 42)	1
Called party number	12.5	O (note 42)	4 - *

*NOTE 42*

*Either 'sending complete' or 'called party number' or both should normally be present.*

**11.2.7 PROGRESS**

This message is sent by the incoming side to indicate the progress of a call in the event of interworking or by either side in connection with the provision of optional in-band information / patterns.

**Table 15 - PROGRESS Message Content**

Message type: PROGRESS

Direction: both

information element	Reference	Type	Length
Protocol discriminator	12.2	M	1
Call reference	12.3	M	3
Message type	12.4	M	1
Cause	12.5	O (note 43)	4 - 32
Progress indicator	12.5	M (note 44)	4

*NOTE 43*

*Included if call failure has to be reported and in-band tones/announcements are provided.*

*NOTE 44*

*May be repeated.*

**11.2.8 RELEASE**

This message is used to indicate that the equipment sending the message has disconnected the channel (if any) and intends to release the channel and the call reference, and that the receiving equipment should release the channel and prepare to release the call reference after sending RELEASE COMPLETE.

**Table 16 - RELEASE Message Content**

Message type: RELEASE

Direction: both

information element	Reference	Type	Length
Protocol discriminator	12.2	M	1
Call reference	12.3	M	3
Message type	12.4	M	1
Cause	12.5	O (note 45)	4 - 32

*NOTE 45*

*Mandatory in the first call clearing message, optional otherwise.*



**11.2.9 RELEASE COMPLETE**

This message is used to indicate that the equipment sending the message has released the channel (if any) and call reference, the channel is available for reuse, and the receiving equipment shall release the call reference.

**Table 17 - RELEASE COMPLETE Message Content**

Message type: RELEASE COMPLETE  
Direction: both

information element	Reference	Type	Length
Protocol discriminator	12.2	M	1
Call reference	12.3	M	3
Message type	12.4	M	1
Cause	12.5	O (note 46)	4 - 32

*NOTE 46*

*Mandatory in the first call clearing message, optional otherwise.*

**11.2.10 SETUP**

This message is sent by the outgoing side to the incoming side to initiate call establishment.

**Table 18 - SETUP Message Content**

Message type: SETUP  
Direction: outgoing to incoming

information element	Reference	Type	Length
Protocol discriminator	12.2	M	1
Call reference	12.3	M	3
Message type	12.4	M	1
Sending complete	12.5	O	1
Bearer capability	12.5	M	4 - 11
Channel identification	12.5	M	4 - *
Progress indicator	12.5	O (note 47)	4
Calling party number	12.5	O	4 - *
Calling party subaddress	12.5	O	4 - 23
Called party number	12.5	M	4 - *
Called party subaddress	12.5	O	4 - 23
Low layer compatibility	12.5	O	4 - 16
High layer compatibility	12.5	O	4 - 5
Transit counter	12.6	O	3
Party category	12.6	O	3

NOTE 47

*May be repeated.*

### 11.2.11 SETUP ACKNOWLEDGE

This message is sent by the incoming side to indicate that call establishment has been initiated, but additional information may be required.

**Table 19 - SETUP ACKNOWLEDGE Message Content**

Message type: SETUP ACKNOWLEDGE

Direction: incoming to outgoing

information element	Reference	Type	Length
Protocol discriminator	12.2	M	1
Call reference	12.3	M	3
Message type	12.4	M	1
Channel identification	12.5	M	4 - *

## 11.3 Messages for Layer Management

### 11.3.1 RESTART

This message is used to request the recipient to restart (i.e. return to idle condition) the indicated channel(s) or interface(s).

**Table 20 - RESTART Message Content**

Message type: RESTART

Direction: both

information element	Reference	Type	Length
Protocol discriminator	12.2	M	1
Call reference	12.3	M (note 48)	3
Message type	12.4	M	1
Channel identification	12.5	O (note 49)	4 - *
Restart indicator	12.5	M	3

NOTE 48

*This message is sent with the global call reference.*

NOTE 49

*Included when the Restart indicator information element indicates that a particular channel is to be restarted.*

**11.3.2 RESTART ACKNOWLEDGE**

This message is sent to acknowledge the receipt of a RESTART message and to indicate that the requested restart is complete.

**Table 21 - RESTART ACKNOWLEDGE Message Content**

Message type: RESTART ACKNOWLEDGE  
 Direction: both

information element	Reference	Type	Length
Protocol discriminator	12.2	M	1
Call reference	12.3	M (note 50)	3
Message type	12.4	M	1
Channel identification	12.5	O (note 51)	4 - *
Restart indicator	12.5	M	3

*NOTE 50*

*This message is sent with the global call reference.*

*NOTE 51*

*Included when the Restart indicator information element indicates that a particular channel has been restarted.*

**12 General message format and coding of information elements**

The figures and text in this section describe message contents. Within each octet, the bit designated "bit 1" is transmitted first, followed by bit 2, 3, 4 etc. Similarly, the octet shown at the top of each figure is sent first.

Whenever a message is sent, according to the procedures of clauses 7, 8 and 9, it shall be coded as specified in this clause, except where the message is segmented according to the procedures of 7.2, in which case each message segment shall be coded as specified in this clause.

**12.1 Overview**

The coding rules follow ETS 300 102.

Every message consists of

- a) Protocol Discriminator (PD),
- b) Call Reference (CR),
- c) Message Type (MT),
- d) other information elements, as required.

information elements a), b) and c) are common to all messages and shall always be present, while elements d) are specific to each message type.



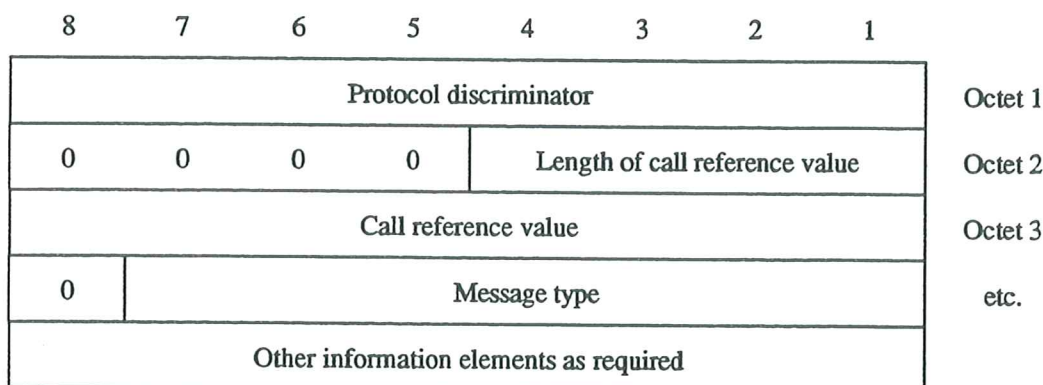

Figure 12 - General Message Organization Example

A particular message may contain more information than a particular (PTN) equipment needs or can understand. All equipment should be able to ignore any extra information that is present in a message, but is not required for the proper operation of that equipment.

Unless specified otherwise, a particular information element shall be present only once in a given message.

The term "default" implies that the value defined shall be used in the absence of any assignment or negotiation of alternative values.

When a field, such as the call reference value, extends over more than one octet, the order of bit values progressively decreases as the octet number increases. The least significant bit of the field is represented by the lowest numbered bit of the highest numbered octet of the field.

12.2 Protocol discriminator

The purpose of the protocol discriminator is to distinguish messages of this specification from any protocol units which also use services of layer 2, but are coded according to other standards. The protocol discriminator is the first part of every message.

The protocol discriminator is coded according to table 22.

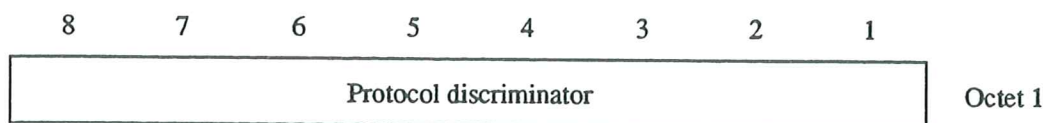

Figure 13 - Protocol Discriminator

Table 22 - Protocol Discriminator

<b>Bits</b>								
8	7	6	5	4	3	2	1	
0	0	0	0	1	0	0	0	Q.931 user-network call control messages

All other values are reserved.

NOTE 52

For the purpose of this Standard, this protocol discriminator should be understood to mean "PTN inter-exchange signalling messages".

12.3 Call Reference

The purpose of the call reference is to identify the call at the local Inter PTNX Link to which the particular message applies. The call reference does not have end-to-end significance across PTNs.

The call reference is the second part of every message. The call reference is coded as shown in figure 14.

8	7	6	5	4	3	2	1	
0	0	0	0	Length of call reference value (in octets)				Octet 1
Flag		Call reference value						Octet 2
Call reference value (cont.)								etc. *) Octet 3

**Figure 14 - Call Reference**

**CR-Flag**

- 0 message is sent from the side that originated the call reference (i.e. from the outgoing side)
- 1 message is sent to the side that originated the call reference (i.e. from the incoming side).

**Length of call reference value (octet 1)**

The call reference value shall always be two octets long; other length values are reserved. The actions taken by the receiver are based on the numerical value of the call reference and are independent of the length of the call reference information element.

The call reference information (octet 2 etc.) comprises two fields: the call reference value and the call reference flag.

**Call reference values**

Call reference values are assigned by the outgoing side of an inter-PTNX link for a call. These values are unique to the outgoing side only within a particular D-channel layer 2 logical link connection. The call reference value is assigned at the beginning of a call and remains fixed for the lifetime of a call. After a call ends, the associated call reference value may be reassigned to a later call. Two identical call reference values on the same D-channel layer 2 logical link connection may be used when each value pertains to a call originated at opposite ends of the link.

**Call reference flag**

The call reference flag can take the values "ZERO" or "ONE". The call reference flag is used to identify which end of the layer 2 logical link originated a call reference. The origination side always sets the call reference flag to "ZERO". The destination side always sets the call reference flag to "ONE".

Hence the call reference flag identifies the side which allocated the call reference value for this call and the only purpose of the call reference flag is to resolve simultaneous uses of the same call reference value.

**Global call reference**

The numerical value of the "global call reference" is zero. It is coded as shown in figure 15. The equipment receiving a message containing the global call reference should interpret the message as pertaining to all call references associated with the appropriate data link connection identifier.

8	7	6	5	4	3	2	1	
0	0	0	0	0	0	1	0	Octet 1
0/1	0	0	0	0	0	0	0	Octet 2
0	0	0	0	0	0	0	0	Octet 3

Figure 15 - Global call reference

**Dummy call reference**

The dummy call reference consists of a single octet with all zeros, as defined in ETS 300 102. It's use is outside the scope of this Standard.

**12.4 Message type**

The purpose of the message type is to identify the function of the message being sent.

The message type is the third part of every message and is coded as shown in figure 16 and table 23.

Bit 8 is reserved for possible future use as an extension bit.

8	7	6	5	4	3	2	1	
0	Message type							Octet 1

Figure 16 - Message type



Table 23 - Message types

8	7	6	5	4	3	2	1	
0	0	0	0	0	0	0	0	Escape to national or private message type
0	0	0						Call establishment messages:
			0	0	0	0	1	ALERTING
			0	0	0	1	0	CALL PROCEEDING
			0	0	1	1	1	CONNECT
			0	1	1	1	1	CONNECT ACKNOWLEDGE
			0	0	0	1	1	PROGRESS
			0	0	1	0	1	SETUP
			0	1	1	0	1	SETUP ACKNOWLEDGE
0	1	0						Call clearing messages:
			0	0	1	0	1	DISCONNECT
			0	1	1	0	1	RELEASE
			1	1	0	1	0	RELEASE COMPLETE
			0	0	1	1	0	RESTART
			0	1	1	1	0	RESTART ACKNOWLEDGE
0	1	1						Miscellaneous messages:
			0	0	0	0	0	SEGMENT
			1	1	0	1	1	INFORMATION
			1	1	1	0	1	STATUS
			1	0	1	0	1	STATUS ENQUIRY

12.5 Other information elements for Basic Call Control (Codeset 0)

12.5.1 Coding rules

The coding of other information elements follows the coding rules described below. These rules are formulated to allow each equipment which processes a message to find information elements important to it, and yet remain ignorant of information elements not relevant to that equipment.

Two categories of information elements are defined:

- a) single octet information elements (see figures 17 and 18);
- b) variable length information elements (see figure 19).

Table 24 summarizes the coding of the information element identifier bits for these information elements of codeset 0 which are used in this Standard. For information elements of codeset 5 refer to 12.6.

The descriptions of the information elements below are ordered alphabetically. However, there is a particular order of appearance for each information element in a message within each codeset. The code values of the information element identifier for the variable length formats are assigned in ascending numerical order, according to the actual order of appearance of each information element in a message. This allows the receiving equipment to detect the presence or absence of a particular information element without scanning through the entire message. The receiving entity is entitled to disregard any information elements (of variable length) which are out of order.

Single octet information elements may appear at any point in the message. Two types of single octet information elements have been defined. Type 1 elements provide the information element identification in bit positions 7, 6, 5. The value "010" in these bit positions is reserved for type 2 single octet elements.

Where the description of information elements in this specification contains spare bits, these bits are indicated as being set to "ZERO". In order to allow compatibility with future implementations, messages should not be rejected simply because a spare bit is set to "ONE".

The second octet of a variable length information element indicates the total length of the contents of that information element (i.e. the length starting with octet 3). It is the binary coding of the number of octets of the contents, with bit 1 as the least significant bit (20).

An optional variable length information element may be present, but empty. For example, a SETUP message may contain a calling party number information element, the content of which is of zero length. This should be interpreted by the receiver as equivalent to that information element being absent. Similarly, an absent information element should be interpreted by the receiver as equivalent to that information element being empty.

The following rules apply for the coding of the contents of variable length information elements (octets 3 etc.):

- a) The first digit in the octet number identifies one octet or a group of octets (i.e. the octets are numbered in a way that reflects the structuring of an information element into groups of one or more octets).
- b) Each octet group is a selfcontained entity. The internal structure of an octet group may be defined in alternative ways.
- c) An octet group is formed by using some extension mechanism. The preferred extension mechanism is to extend an octet (N) to the next octet(s) (Na, Nb, etc.) by using bit 8 in each octet as an extension bit. The bit value "ZERO" indicates that the octet continues through the next octet. The bit value "ONE" indicates that this octet is the last octet of the group. If one octet (e.g. Nn) is present, the preceding octets (N and Na) must also be present.

In the format descriptions of the following paragraphs, bit 8 is marked "0/1 ext" if another octet follows. Bit 8 is marked "1" or "1 ext" if this is the last octet in the extension domain (octet group).

Additional octets may be defined later ("1 ext" changed to "0/1 ext") and equipments shall be prepared to receive such additional octets, although the equipment need not be able to interpret or act upon the content of these octets.

- d) In addition to the extension mechanism defined above, an octet (N) may be extended through the next octet(s) (N.1, N.2 etc.) by indications in bits 7 to 1 of octet N.
- e) The mechanisms in c) and d) may be combined.
- f) Optional octets are marked with asterisks (\*).

**Structure of information elements:**

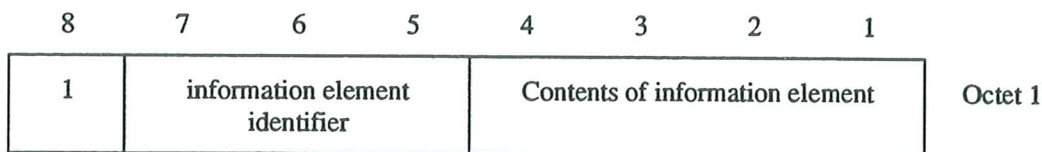

**Figure 17 - Single Octet information element Format (type 1)**

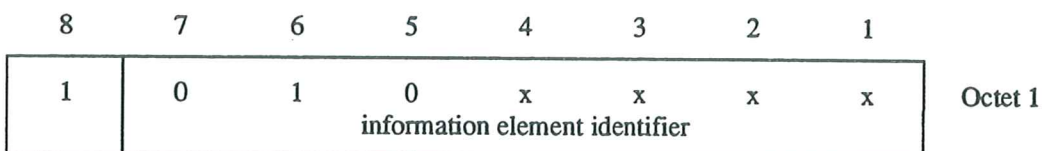

**Figure 18 - Single Octet information element Format (type 2)**

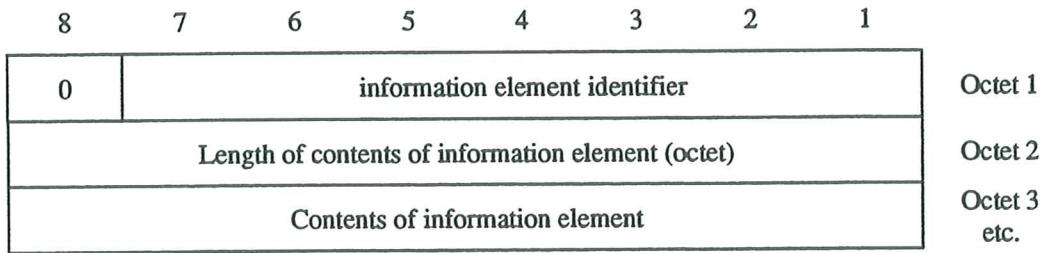

Figure 19 - Variable Length information element Format

Table 24 - information element Identifier Coding (Codeset 0)

Coding								Reference	Max. length (octets)
8	7	6	5	4	3	2	1		
1	:	:	:	-	-	-	-	Single octet information elements:	
	0	0	0	-	-	-	-	reserved	
	0	0	1	-	-	-	-	shift	12.5.3
	0	1	0	0	0	0	1	sending complete	12.5.20
0	:	:	:	:	:	:	:	Variable length information elements:	
	0	0	0	0	0	0	0	segmented message	12.5.19
	0	0	0	0	1	0	0	bearer capability	12.5.5
	0	0	0	1	0	0	0	Cause	12.5.11
	0	0	1	0	1	0	0	call state	12.5.6
	0	0	1	1	0	0	0	channel identification	12.5.12
	0	0	1	1	1	1	0	progress indicator	12.5.17
	1	0	0	1	1	0	0	connected number	12.5.13
	1	0	0	1	1	0	1	connected subaddress	12.5.14
	1	1	0	1	1	0	0	calling party number	12.5.9
	1	1	0	1	1	0	1	calling party subaddress	12.5.10
	1	1	1	0	0	0	0	called party number	12.5.7
	1	1	1	0	0	0	1	called party subaddress	12.5.8
	1	1	1	1	0	0	1	restart indicator	12.5.18
	1	1	1	1	1	0	0	low layer compatibility	12.5.16
	1	1	1	1	1	0	1	high layer compatibility	12.5.15
all other values are reserved (note 53)									

Note to table 24:

NOTE 53

The reserved values with bits 5-8 coded "0000" are for future information elements for which comprehension by the receiver is required.

### 12.5.2 Extension of codesets

There is a certain number of possible information element identifier values using the formatting rules described in 12.5.1; 128 from the variable length information element format and at least 8 from the single octet information element format.



One value in the single octet format is specified for the shift operations described below. One other value in both the single octet and variable length format is reserved. This leaves at least 133 information element identifier values available for assignment.

It is possible to expand this structure to eight codesets of at least 133 information element identifier values each. One common value in the single octet format is employed in each codeset to facilitate shifting from one codeset to another. The contents of this shift information element identifies the codeset to be used for the next information element or elements. The codeset in use at any given time is referred to as the "active codeset". By convention, codeset 0 is the initially active codeset.

Two codeset shifting procedures are possible: locking shift and non-locking shift.

Transition from one active codeset to another (i.e. by means of the locking shift procedure) may only be made to a codeset with a higher numerical value than the codeset being left.

An information element belonging to one codeset may appear in between information elements belonging to another codeset (being the active codeset) by using the non-locking shift procedure.

An equipment shall have the capability to recognize a shift information element and to treat the subsequent information element(s) as belonging to the specified shift. information elements from non-supported shifts shall be treated as unrecognized if received in a message. The error procedures for unrecognized information elements apply.

Codeset 6 and/or codeset 7 may be used for conveying non-standardized information between adjacent PTNXs (e.g. for manufacturer or network specific purposes).

Codeset 5 is used by ETSI for information elements which are defined in addition to CCITT Recommendation Q.931. The rules for handling information elements of codeset 0 apply to codeset 5, too. See also 12.6.

### 12.5.3 Locking shift procedure

The locking shift procedure employs an information element to indicate the new active codeset. The specified codeset remains active until another locking shift information element is encountered which specifies the use of another codeset. For example, codeset 0 is active at the start of message content analysis. If a locking shift to codeset 5 is encountered, the next information elements will be interpreted according to the information element identifiers assigned in codeset 5, until another shift information element is encountered.

This procedure is used only to shift to a higher order codeset than the one being left.

The locking shift is valid only within the message that contains the locking shift information element. At the start of every message content analysis, the active codeset is codeset 0.

The locking shift information element uses the single octet information element format and is coded as shown in figure 20 and table 25.

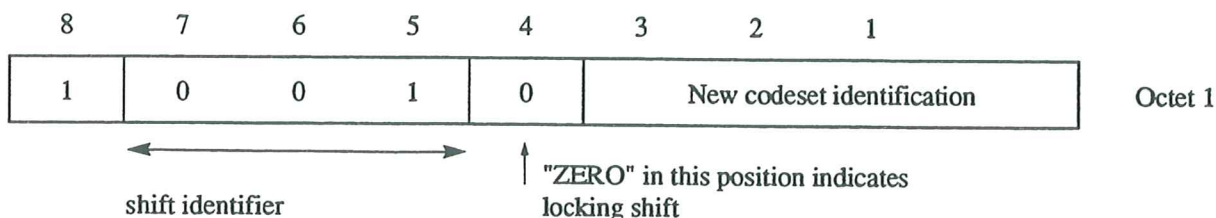

Figure 20 - Locking Shift Element

**Table 25 - Locking/Non-locking Shift Element**

**Codeset identification**

Bits				
3	2	1		
0	0	0	Codeset 0:	ETS 300 102-1 information elements (initially active codeset)
1	0	1	Codeset 5:	information elements defined by ETSI / ECMA
1	1	0	Codeset 6:	information elements specific to the local network (public or private)
1	1	1	Codeset 7:	User-specific information elements

All other values are reserved

**12.5.4 Non-locking shift procedure**

The non-locking shift procedure provides a temporary shift to the specified lower or higher codeset. It uses a single octet information element to indicate the codeset to be used to interpret the next single information element. After the interpretation of that information element, the active codeset is again used for interpreting any following information elements. For example, codeset 0 is active at the beginning of message content analysis. If a non-locking shift to codeset 6 is encountered, only the next information element is interpreted according to the information element identifiers assigned in codeset 6. After that codeset 0 will again be used to interpret the following information elements. A non-locking shift information element indicating the current codeset shall not be regarded as an error.

A locking shift information element shall not follow directly on a non-locking shift information element. If this combination is received it shall be interpreted as though a locking shift information element only had been received.

The single octet non-locking shift information element format and coding is shown in figure 21 and table 25.

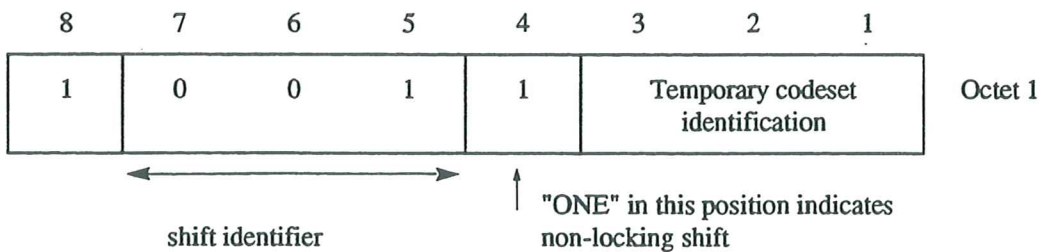

**Figure 21 - Non-locking Shift Element**

**12.5.5 Bearer capability**

The purpose of the bearer capability information element is to indicate a requested ETS 300 171 bearer capability to be provided by the network.

The bearer capability information element is coded as shown in figure 22 and table 26.

Receipt of any value designated as reserved shall not cause a protocol error.

8	7	6	5	4	3	2	1	
0	0	0	0	0	1	0	0	Octet 1
information element identifier								
Length of bearer capability contents								Octet 2
1 ext	Coding standard		Information transfer capability					Octet 3
1 ext	Transfer mode		Information transfer rate					Octet 4 Note 54
0/1 ext	0	1	User information layer 1 protocol					Octet 5* Note 55
		Layer ID (1)						

**Figure 22 - Bearer capability information element**

Notes to figure 22:

**NOTE 54**

As only default values are used for all fields of ETS 300 102 octets 4a and 4b, these octets shall not be used. The following values shall be assumed:

Structure: circuit mode: 8 kHz integrity  
 Configuration: point-to-point  
 Establishment: demand  
 Symmetry: bi-directional symmetric.

**NOTE 55**

The contents of optional octets 5a, 5b, 5c, 5d, 6 and 7 have no impact at the Q-reference point, and are therefore not specified in this Standard.

One or more of these octets may be included, in accordance with the rules of ETS 300 102.

Receipt of any of these octets regardless of contents shall not cause a protocol error.

**Table 26 - Bearer capability**

**Coding standard (octet 3)**

**Bits**  
**7 6**

0 0 CCITT standardized coding

All other values are reserved.



Table 26 - Bearer capability (continued)

**Information transfer capability (octet 3)**

Bits					
5	4	3	2	1	
0	0	0	0	0	Speech
0	1	0	0	0	Unrestricted digital information
0	1	0	0	1	Restricted digital information (applicable only in interworking situations)
1	0	0	0	0	3,1 kHz audio
1	0	0	0	1	7 kHz audio
1	1	0	0	0	Videotelephony

All other values are reserved.

**Transfer mode (octet 4)**

Bits		
7	6	
0	0	Circuit mode

All other values are reserved.

**Information transfer rate (octet 4)**

Bits					
5	4	3	2	1	
1	0	0	0	0	64 kbit/s

All other values are reserved.

**User information layer 1 protocol (octet 5)**

Bits					
5	4	3	2	1	
0	0	0	1	0	CCITT Recommendation G.711 $\mu$ -law
0	0	0	1	1	CCITT Recommendation G.711 A-law

All other values are outside the scope of this Standard.

**NOTE 56**

*If the transfer mode is "circuit mode", and if the information transfer capability is "unrestricted digital information" or "restricted digital information", octet 5 may be omitted. Otherwise, octet 5 shall be present.*

*If the transfer mode is "circuit mode", and if the information transfer capability is "speech" or "3,1 kHz audio", octet 5 shall indicate either "CCITT Recommendation G.711  $\mu$ -Law" or "CCITT Recommendation G.711 A-Law".*

**12.5.6 Call state**

The purpose of the call state information element is to indicate the current state of a call or a global interface state. The call state information element is coded as shown in figure 23 and table 27.

8	7	6	5	4	3	2	1	
0	0	0	1	0	1	0	0	Octet 1
information element identifier								
Length of call state value								Octet 2
Coding standard				Call state value / global interface state value				Octet 3

Figure 23 - Call state information element

Table 27 - Call state

**Coding standard (octet 3)**

Bits

8 7

0 0 CCITT standardized coding, as described below.

All other values are reserved.

**Call state value (octet 3)**

Bits

6 5 4 3 2 1

Value

Circuit Mode Protocol Control State

0 0 0 0 0 0

0

Null

0 0 0 0 0 1

1

Call initiated

0 0 0 0 1 0

2

Overlap sending

0 0 0 0 1 1

3

Outgoing call proceeding

0 0 0 1 0 0

4

Call delivered

0 0 0 1 1 0

6

Call present

0 0 0 1 1 1

7

Call received

0 0 1 0 0 0

8

Connect request

0 0 1 0 0 1

9

Incoming call proceeding

0 0 1 0 1 0

10

Active

0 0 1 0 1 1

11

Disconnect request

0 0 1 1 0 0

12

Disconnect indication

0 1 0 0 1 1

19

Release request

0 1 1 0 0 1

25

Overlap receiving

**Global interface state value (octet 3)**

Bits

6 5 4 3 2 1

State

0 0 0 0 0 0

REST 0 - null

1 1 1 1 0 1

REST 1 - restart request

1 1 1 1 1 0

REST 2 - restart

**12.5.7 Called party number**

The purpose of the called party number information element is to identify the called party of a call. The called party number information element is coded as shown in figure 24 and table 28.

The maximum length of this information element is network dependent.

8	7	6	5	4	3	2	1	
0	1	1	1	0	0	0	0	Octet 1
information element identifier								
Length of called party number contents								Octet 2
1	Type of number			Numbering plan identification				Octet 3
0 Spare	Number digits							Octet 4 (repeated)

**Figure 24 - Called party number information element**

Note to figure 24:

**NOTE 57**

The number digits appear in multiple octets 4 in the same order in which they would be entered, i.e. the number digit which would be entered first is located in the first octet 4.

**Table 28 - Called party number**

**Type of number (octet 3)(Note 61)**

Bits 7 6 5	Meaning	
	<b>E.164</b>	<b>Private numbering plan (Note 58)</b>
0 0 0	Unknown (Note 60)	Unknown
0 0 1	International number (Note 59)	Level 2 regional number
0 1 0	National number (Note 59)	Level 1 regional number
0 1 1	Reserved	PTN specific number
1 0 0	Subscriber number (Note 59)	Local number
1 0 1	Reserved	Reserved
1 1 0	Reserved	Abbreviated number
1 1 1	Reserved	Reserved

**Numbering plan identification (octet 3)**

**Numbering plan**

Bits 4 3 2 1	
0 0 0 0	Unknown (Note 62)
0 0 0 1	ISDN numbering plan (CCITT Recommendation E.164)
0 0 1 1	Data numbering plan (CCITT Recommendation X.121)
0 1 0 0	Telex numbering plan (CCITT Recommendation F.69)
1 0 0 1	Private numbering plan

All other values are reserved.

**Number digits (octets 4, etc.)**

This field is coded with CCITT Recommendation T.50 characters, according to the formats specified in the appropriate numbering/dialling plan.



Notes to table 28:

**NOTE 58**

Private numbering plan is specified in ETS 300 189. That standard also defines the terms 'regional number' and 'local number'.

**NOTE 59**

For the definition of international, national and subscriber number. see CCITT Recommendation I.330. Prefix or escape digits shall not be included in these numbers.

**NOTE 60**

The type of number "unknown" is used when the user or the network has no knowledge of the type of number, e.g. international number, national number, etc. In this case the number digits field is organized according to the network dialling plan; prefix or escape digits might be present.

**NOTE 61**

With numbering plans other than E.164 or private numbering plan the only permissible type of number value shall be unknown (0000).

**NOTE 62**

The numbering plan identification "unknown" is used when the user or the network has no knowledge of the numbering plan identification. In this case the number digits field is organized according to the network dialling plan; prefix or escape digits might be present.

**12.5.8 Called party subaddress**

The purpose of the called party subaddress information element is to identify the subaddress of the called party of a call. For the definition of subaddress, see ETS 300 189.

Refer to ETS 300 102 for coding rules for this information element.

The maximum length of the called party subaddress information element is 23 octets.

**12.5.9 Calling party number**

The purpose of the calling party number information element is to identify the origin of a call.

The calling party number information element is coded as shown in figure 25 and table 29.

The maximum length of this information element is network dependent.

	8	7	6	5	4	3	2	1	
	0	1	1	0	1	1	0	0	Octet 1
	information element identifier								
	Length of calling party number contents								Octet 2
0/1 ext	Type of number			Numbering plan identification					Octet 3
1 ext	Presentation indicator	0 0 0 Spare			Screening indicator			Octet 3a*	
0 Spare	Number digits								Octet 4 (repeated)

**Figure 25 - Calling party number information element**

Note to figure 25:

NOTE 63

Octets 2, 3 and 4 of this information element are coded as in the "called party number" information element.

**Table 29 - Calling party number**

**Presentation indicator (octet 3a)**

Bits		
7	6	
0	0	Presentation allowed
0	1	Presentation restricted
1	0	Number not available due to interworking
1	1	Reserved

**Screening indicator (octet 3a)**

Bits		
2	1	
0	0	User-provided, not screened
0	1	User-provided, verified and passed
1	0	Reserved
1	1	Network-provided

Notes to table 29:

NOTE 64

If octet 3a is omitted "0 0 - Presentation allowed" is assumed.

NOTE 65

If octet 3a is omitted, "0 0 - User-provided not screened" is assumed.

**12.5.10 Calling party subaddress**

The purpose of the Calling party subaddress information element is to identify a subaddress associated with the origin of a call.

Refer to ETS 300 102 for coding rules for this information element.

The maximum length of this information element is 23 octets.

**12.5.11 Cause**

The purpose of the Cause information element is to describe the reason for generating certain messages, to provide diagnostic information in the event of procedural errors, and to indicate the location of the cause originator.

The Cause information element is coded as shown in figure 26 and tables 30, 31, 32.

The maximum length of this information element is 32 octets.

8	7	6	5	4	3	2	1	
0	0	0	0	1	0	0	0	Octet 1
information element identifier								
Length of cause contents								Octet 2
1 ext	Coding standard	0 Spare	Location					Octet 3 Note 66
1 ext	Cause value						Octet 4	
Diagnostics (if any)								Octet 5*

**Figure 26 - Cause information element**

Note to figure 26:

NOTE 66

The optional octet 3a of ETS 300 102 has been omitted here since only the default value 'Recommendation=Q.931' is used in this Standard. As stated in 12.5.1, an implementation shall be prepared to receive an extension octet 3a, which shall not result in a protocol error for invalid contents.

**Table 30 - Cause information element**

**Coding standard (octet 3)**

**Bits**

7 6

0 0 CCITT standardized coding as described below

All other values are reserved.

**Location (octet 3)**

**Bits**

4 3 2 1

- 0 0 0 0 User
- 0 0 0 1 Private network serving the local user
- 0 0 1 0 Public network serving the local user
- 0 0 1 1 Transit network
- 0 1 0 0 Public network serving the remote user
- 0 1 0 1 Private network serving the remote user
- 0 1 1 1 International network
- 1 0 1 0 Network beyond interworking point

All other values are reserved.



**Table 30 - Cause information element (continued)**

**Cause value (octet 4)**

The following rules apply to the coding of cause values:

- a) All values in the range 0 through 127 shall be accepted as valid cause values.
- b) Table 31 lists cause values which are explicitly mentioned elsewhere in this Standard. These cause values are coded according to ETS 300 102: The value is divided into two fields, a class (bits 5 through 7) and a value within the class (bits 1 through 4).

The class indicates the general nature of the event.

Class (000) :	normal event
Class (001) :	normal event
Class (010) :	resource unavailable
Class (011) :	service or option not available
Class (100) :	service or option not implemented
Class (101) :	invalid message (e.g. parameter out of range)
Class (110) :	protocol error (e.g. unknown message)
Class (111) :	interworking

Refer to ETS 300 102 for further details.

- c) The list of cause values in table 31 is not exclusive, in the sense that the sending entity may choose cause values from ETS 300 102 other than those listed in table 31, except where procedures of this Standard specify the use of particular cause values, in which case those values should be used.

**Diagnostics (octet 5)**

Diagnostic information is not available for every cause; see tables 31 and 32 on the next pages. The inclusion of diagnostics is optional.

If the diagnostic information cannot be interpreted this shall not lead to a protocol error.

**Table 31 - Cause information element**

Cause value							Cause number	Cause	Diagnostics
Class			Value						
7	6	5	4	3	2	1			
0	0	0	0	0	0	1	1	Unallocated (unassigned) number	(note 67)
0	0	0	0	0	1	1	3	No route to destination	(note 67)
0	0	0	0	1	1	0	6	Channel unacceptable	-
0	0	1	0	0	0	0	16	Normal call clearing	(note 67)
0	0	1	0	0	0	1	17	User busy	-
0	0	1	0	0	1	0	18	No user responding	-
0	0	1	0	0	1	1	19	No answer from user (user alerted)	-
0	0	1	0	1	0	1	21	Call rejected	(note 67) User supplied diagnostics (note 68)
0	0	1	0	1	1	0	22	Number changed	New destination (note 69)
0	0	1	1	0	1	1	27	Destination out of order	-
0	0	1	1	1	0	0	28	Invalid number format	-
0	0	1	1	1	1	0	30	Response to STATUS ENQUIRY	-
0	0	1	1	1	1	1	31	Normal, unspecified	-
0	1	0	0	0	1	0	34	No circuit/channel available	-
0	1	0	1	0	0	1	41	Temporary failure	-
0	1	0	1	1	0	0	44	Requested circuit/channel not available	-
0	1	1	1	0	0	1	57	Bearer capability not authorized	(note 71)
0	1	1	1	0	1	0	58	Bearer capability not presently available	(note 71)
0	1	1	1	1	1	1	63	Service or option not available, unspecified	-
1	0	0	0	0	0	1	65	Bearer capability not implemented	(note 71)
1	0	1	0	0	0	1	81	Invalid call reference value	-
1	0	1	1	0	0	0	88	Incompatible destination	Incompat. param. (note 72)
1	1	0	0	0	0	0	96	Mandatory information element is missing	Info. element ID(s) (note 70)
1	1	0	0	0	0	1	97	Message type non-existent or not implemented	Message type
1	1	0	0	0	1	0	98	Message not compatible with call state or message type non-existent or not implemented	Message type
1	1	0	0	0	1	1	99	information element non-existent or not implemented	Info. element ID(s) (notes 70, 73)
1	1	0	0	1	0	0	100	Invalid information element contents	Info. element ID(s) (note 70)
1	1	0	0	1	0	1	101	Message not compatible with call state	Message type
1	1	0	0	1	1	0	102	Recovery on timer expiry	Timer number (note 74)
1	1	0	1	1	1	1	111	Protocol error, unspecified	-

Notes to table 31:

**NOTE 67**

The following coding is used:

Bit 8: 1

Bit 7-3 : 00000

Bit 2-1: persistence of condition as follows:

00 - Unknown

01 - Permanent

10 - Transient

**NOTE 68**

User supplied diagnostics field is encoded according to the user specification, subject to the maximum length of the Cause information element. The coding of user supplied diagnostics should be made in such a way that it does not conflict with the coding described in Note 67 above.

**NOTE 69**

New destination' is formatted as called party information element, including the information element identifier.

**NOTE 70**

- a) Locking and non-locking shift procedures are applied.
- b) In principle, information element identifiers are ordered in the same order as the information elements in the received message.

**NOTE 71**

The format of the diagnostic field for Cause nos. 57, 58 and 65 is as shown in figure 27 and in table 32 below.

**NOTE 72**

Incompatible information element identifier.

**NOTE 73**

When only a locking shift information element is included and no variable length information element identifier follows, it means that the codeset in the locking shift itself is not implemented.

**NOTE 74**

The timer is coded in CCITT Recommendation T.50 characters, e.g. T308 is coded as "3"0"8" in bits 7-1 of octets 5, 5a, 5b, with bit 8 being ZERO (spare).

8	7	6	5	4	3	2	1	
0/1 ext	Attribute number						Octet 5	
0/1 ext	Rejected attribute						Octet 5a	
1 ext	Available attribute						Octet 5b*	

**Figure 27 - Cause information element - Diagnostic Field for Causes 57, 58, 65**



Notes to figure 27:

**NOTE 75**

When diagnostic information is provided, octets 5 and 5a shall be present; octet 5b is optional.

**NOTE 76**

Octets 5 through 5b may be repeated to report multiple rejected attributes.

**Table 32 - Coding of Diagnostics Field for Causes 57, 58, 65**

**Attribute number (octet 5)**

Bits								Number Attribute	
7	6	5	4	3	2	1			
0	1	1	0	0	0	1	1	Information transfer capability	
0	1	1	0	0	1	0	2	Information transfer mode	
0	1	1	0	0	1	1	3	Information transfer rate	
0	1	1	0	1	0	0	4	Structure (Note 77)	
0	1	1	0	1	0	1	5	Configuration (Note 77)	
0	1	1	0	1	1	0	6	Establishment (Note 77)	
0	1	1	0	1	1	1	7	Symmetry (Note 77)	
0	1	1	1	0	0	0	8	Information transfer rate (dest-->orig) (Note 77)	
0	1	1	1	0	0	1	9	Layer identification (Layer 1, 2, 3)	

**Rejected attribute (octet 5a) / Available attribute (octet 5b)**

**Attribute No.**

**1. Information transfer capability:**

Bits 7 - 6: 0 0

Bits 5 - 1: according to table 26, octet 3

**2. Information transfer mode:**

Bits 7 - 6: according to table 26, octet 4

Bits 5 - 1: 0 0 0 0 0

**3. Information transfer rate:**

Bits 7 - 6: 0 0

Bits 5 - 1: according to table 26, octet 4

**4. Structure:**

Bits 7 - 5: according to ETS 300 102, table 4-6, octet 4a (Note 77)

Bits 4 - 1: 0 0 0 0

**5. Configuration:**

Bits 7 - 5: 0 0 0

Bits 4 - 3: according to ETS 300 102, table 4-6, octet 4a (Note 77)

Bits 2 - 1: 0 0

**6. Establishment:**

Bits 7 - 3: 0 0 0 0 0

Bits 2 - 1: according to ETS 300 102, table 4-6, octet 4a (Note 77)

7. Symmetry:

Bits 7 - 6: according to ETS 300 102, table 4-6, octet 4b (Note 77)

Bits 5 - 1: 0 0 0 0 0

8. Information transfer rate ( dest.? origin.):

Bits 7 - 6: 0 0

Bits 5 - 1: according to ETS 300 102, table 4-6, octet 4b (Note 77)

9. Layer Identification (Layer 1-3):

Bits 7 - 1: according to table 26, octet 5 (Layer 1) or according to ETS 300 102, table 4-6.

Note to table 32:

NOTE 77

Attributes 4 - 8 each have only one value specified in this Standard, and therefore these attributes should not normally be the subject of the diagnostics field.

12.5.12 Channel identification

The purpose of the channel identification information element is to identify a channel which is controlled by these signalling procedures

The channel identification information element is coded as shown in figure 28 and table 33.

The default maximum length of this information element is network dependent.

8	7	6	5	4	3	2	1	
0	0	0	1	1	0	0	0	Octet 1
information element identifier								
Length of channel identification contents								Octet 2
1 ext	Interf. ID	Interf. type	0 Spare	Pref/ Excl.	D-chan Ind	Info. channel Selection		Octet 3 Note 78
1 ext	Coding standard		Number/ map	Channel type				Octet 3.2
0/1 ext	Channel number							Octet 3.3

Figure 28 - Channel identification information element

Note to figure 28:

NOTE 78

Since the interface is never explicitly identified at the Q reference point, octet 3.1 of ETS 300 102 is always omitted.

**Table 33 - Channel identification information element**

**Interface identifier present (octet 3)**

**bit 7**

- 0 interface implicitly identified
- 1 reserved

**Interface type (octet 3)**

**bit 6**

- 0 reserved
- 1 other than basic interface; e.g. primary rate

**Preferred/Exclusive (octet 3)**

**bit 4**

- 0 indicated channel is preferred
- 1 exclusive; only the indicated channel is acceptable

**D-channel indicator (octet 3)**

**bit 3**

- 0 the channel identified is not the D-channel
- 1 reserved

**Information channel selection (octet 3) (Note 81)**

**bits**

2 1

- 0 1 as indicated in following octets

All other values are reserved.

**Coding standard (octet 3.2)**

**bits**

7 6

- 0 0 CCITT standard

All other values are reserved.

**Number / Map (octet 3.2)**

**bit 5**

- 0 channel is indicated by the number in the following octet
- 1 reserved

**Channel type (octet 3.2)**

**bits**

4 3 2 1

- 0 0 1 1 B-channel units

All other values are reserved.

**Channel number (octet 3.3)**

Binary number assigned to the channel.  
Channels are numbered from 1 upwards.

*Notes to table 33:*

*NOTE 79*

*Preferred / exclusive has significance only for B-channel selection.*

*NOTE 80*

*D-channel indication has significance in D-channel use. No other information affects D-channel use.*



**NOTE 81**

The information channel selection does not apply to the D-channel.

**NOTE 82**

This octet may be extended if the channel number exceeds 127.

**12.5.13 Connected number**

The purpose of the connected number information element is to indicate which number is connected to a call. The connected number may be different from the called party number because of changes (e.g. call redirection, transfer) during the lifetime of the call.

The connected number information element is coded as shown in figure 29 and table 29 (see 12.5.9, Calling party number).

8	7	6	5	4	3	2	1	
Connected number								
0	1	0	0	1	1	0	0	Octet 1
information element identifier								
Length of connected number information								Octet 2
0/1 ext	Type of number			Numbering plan identification				Octet 3
1 ext	Presentation Indicator	0	0	0	Screening Indicator			Octet 3a*
0 Spare	Number digits							Octet 4 (repeated)

**Figure 29 - Connected number information element**

**12.5.14 Connected subaddress**

The purpose of the connected subaddress information elements is to identify the subaddress of the connected party of a call. The connected subaddress may be different from the called party subaddress because of changes (e.g. call redirections, transfer) during the lifetime of the call.

The connected subaddress information element is coded in the same way as the called party subaddress IE, apart from the IE identifier (octet 1).

The maximum length of this information element is 23 octets.

**12.5.15 High layer compatibility (Layers 4 - 7)**

The purpose of the high layer compatibility information element is to provide a means which, in association with the bearer capability and low layer compatibility information elements, may be used by the remote user for compatibility checking.

Refer to ETS 300 102 for the coding of the high layer compatibility information element.

The maximum length of the high layer compatibility information element is 5 octets.

Receipt of values not defined in ETS 300 102 shall not cause a protocol error, provided the maximum length is not exceeded.

**12.5.16 Lower layer compatibility (Layers 1 - 3)**

The purpose of the low layer compatibility information element is to provide a means which, in conjunction with the bearer capability and high layer compatibility information elements, may be used by the addressed entity (e.g. remote user) for compatibility checking.

Refer to ETS 300 102 for the coding of the low layer compatibility information element.

The maximum length of this information element is 16 octets.

Receipt of values not defined in ETS 300 102 shall not cause a protocol error, provided the maximum length is not exceeded.

**12.5.17 Progress indicator**

The purpose of the progress indicator information element is to describe an event which has occurred during the life of a call.

The progress indicator information element is coded as shown in figure 30 and table 34.

The default maximum length of this information element is 4 octets.

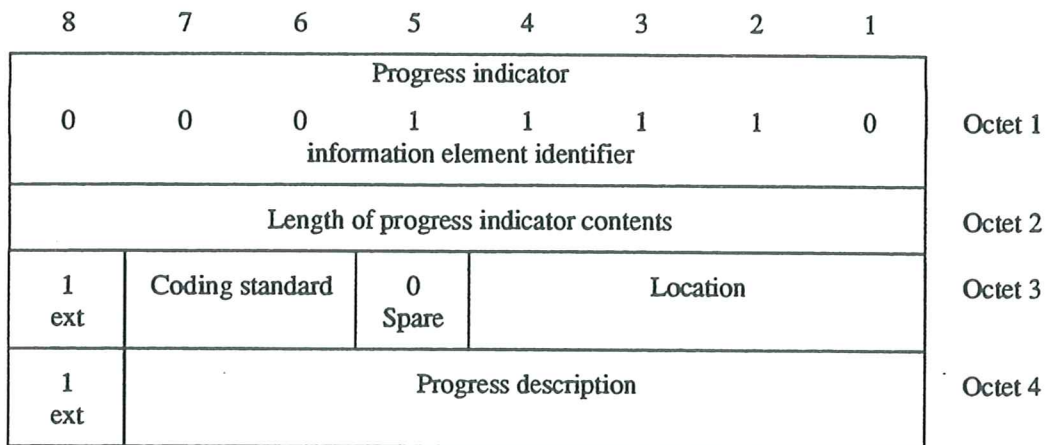

**Figure 30 - Progress indicator information element**

**Table 34 - Progress indicator information element**

**Coding standard (octet 3)**

**Bits**

7 6

0 0 CCITT standardized coding as described below

0 1 ECMA standardized coding as described below

All other values are reserved.

**Table 34 - Progress indicator information element (continued)**

**Location (octet 3) (Note 84)**

Bits				
4	3	2	1	
0	0	0	0	User
0	0	0	1	Private network serving the local user
0	0	1	0	Public network serving the local user
0	1	0	0	Public network serving the remote user
0	1	0	1	Private network serving the remote user
0	1	1	1	International network
1	0	1	0	Network beyond interworking point

All other values are reserved.

**Progress description (octet 4)**

**1. CCITT standardized coding**

Bits							No	Meaning
7	6	5	4	3	2	1		
0	0	0	0	0	0	1	1	Call is not end-to-end ISDN, further call progress information may be available in-band
0	0	0	0	0	1	0	2	Destination address is non-ISDN
0	0	0	0	0	1	1	3	Origination address is non-ISDN
0	0	0	0	1	0	0	4	Call has returned to the ISDN
0	0	0	1	0	0	0	8	In-band information or appropriate pattern now available

All other values are reserved.

**2. ECMA standardized coding**

Bits							No	Meaning
7	6	5	4	3	2	1		
0	0	1	0	0	0	0	16	Interworking with a public network
0	0	1	0	0	0	1	17	Interworking with a network unable to supply a release signal
0	0	1	0	0	1	0	18	Interworking with a network unable to supply a release signal before answer
0	0	1	0	0	1	1	19	Interworking with a network unable to supply a release signal after answer
0	0	1	0	1	0	0	20	Interworking with another private network

All other values are reserved.

Notes to table 34:

**NOTE 83**

Progress description 1 indicates that interworking with a non-ISDN has occurred within the network or networks which the call has traversed.

Progress description 2 indicates that the destination user equipment is non-ISDN equipment.

Progress description 3 indicates that the origination user equipment is non-ISDN equipment.

Progress description 4 indicates that a call which has left the ISDN has returned at the same point it had left due to redirection within the non-ISDN.

**NOTE 84**

The location field is applicable to both CCITT and ECMA coding standards.



**12.5.18 Restart indicator**

The purpose of the restart indicator is to identify the entity (i.e. specific channel, all channels) to be restarted or which has been restarted.

The restart indicator information element is coded as shown in figure 31 and table 35.

8	7	6	5	4	3	2	1	
0	1	1	1	1	0	0	1	Octet 1
information element identifier								
Length of restart indicator								Octet 2
1 ext	0	0	0	0	Class			Octet 3

**Figure 31 - Restart indicator information element**

**Table 35 - Restart indicator information element**

**Class (octet 3)**

Bits			Meaning
3	2	1	
0	0	0	Indicated channel (Note 85)
1	1	1	All channels (Note 86)

All other values are reserved.

*Notes to table 35:*

**NOTE 85**

*The channel identification information element shall be included, indicating which channel is to be restarted or has been restarted.*

**NOTE 86**

*All channels means the D-channel on which the restart indicator is carried and all B-channels associated with that D-channel.*

**12.5.19 Segmented message**

The purpose of the segmented message information element is to indicate, in conjunction with the message type "SEGMENT", that the transmission in which it appears is part of a segmented message. When included in a message segment (i.e. a message of type 'SEGMENT'), it appears directly after the message type information element.

The segmented message information element is coded as shown in figure 32 and table 36.

8	7	6	5	4	3	2	1	
0	0	0	0	0	0	0	0	Octet 1
Segmented message information element identifier								
Length of segmented message contents								Octet 2
1st seg ind.	Number of segments remaining							Octet 3
0	Segmented message type							Octet 4

Figure 32 - Segmented message information element

Table 36 - Segmented message Information Content

**First segment indicator (octet 3)**

**Bit 8**

- 0 Subsequent segment to first segment
- 1 First segment of segmented message

**Number of segments remaining (octet 3)**

Binary number indicating the number of remaining segments within the message to be sent.

**Segmented message type (octet 4)**

Type of message being segmented, coded according to 12.4.

*Note to table 36:*

*NOTE 87*

*Bit 8 is reserved for possible future use as an extension bit.*

**12.5.20 Sending complete**

The purpose of the sending complete information element is to optionally indicate completion of the called party number.

This is a single octet information element coded as shown in figure 33.

8	7	6	5	4	3	2	1	
1	0	1	0	0	0	0	1	Octet 1
Sending complete information element								

Figure 33 - Sending complete information element

**12.6 Information elements of Codeset 5**

Codeset 5 contains information elements defined by ETSI.

In general the coding rules described in 12.5.1 for codeset 0 apply also to codeset 5.

Table 37 lists the information element identifiers for information elements of codeset 5 which are used in this Standard.

**Table 37 - information element Identifier Coding (Codeset 5)**

Coding								Refer- ence	Length
8	7	6	5	4	3	2	1		
1	:	:	:	-	-	-	-	Single Octet information elements:	
	0	0	0	-	-	-	-	reserved	
	0	0	1	-	-	-	-	shift	12.5.3
0	:	:	:	:	:	:	:	Variable length information elements:	
	0	1	1	0	0	0	1	transit counter	12.6.2
	0	1	1	0	0	1	0	party category	12.6.1
All other values are reserved									

**12.6.1 Party category**

The purpose of this information element is to indicate the category of a party involved in a call.

The party category information element is coded as shown in figure 34.

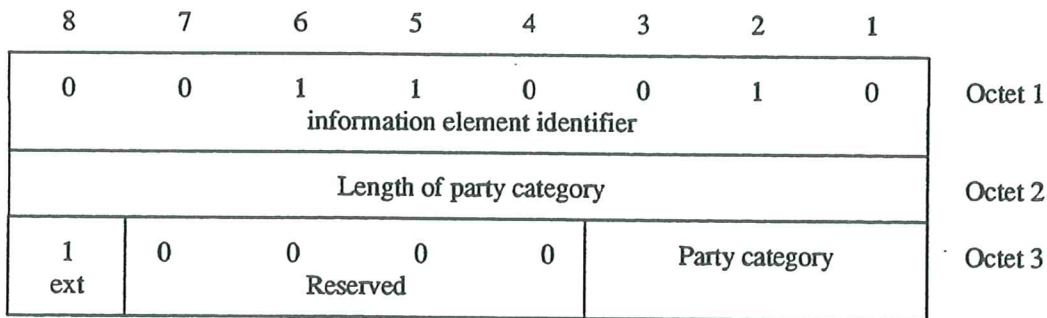

**Figure 34 - Party category information element**

**Table 38 - Party category**

**Party category (octet 3)**

<b>Bits</b>	<b>3</b>	<b>2</b>	<b>1</b>	
	0	0	0	unknown
	0	0	1	extension
	0	1	0	operator
	0	1	1	emergency extension

All other values are reserved.

**12.6.2 Transit counter**

The purpose of the transit counter information element is to limit the number of transit PTNXs that a call setup request may be routed through, in order to protect the network against indefinite looping.

The maximum transit count is a network dependent value in the range 0 ... 31.

The transit counter information element is coded as shown in figure 35.



8	7	6	5	4	3	2	1	
0	0	1	1	0	0	0	1	Octet 1
information element identifier								
Length of transit counter								Octet 2
1 ext	0	0	Transit count (binary value)					Octet 3
Reserved								

**Figure 35 - Transit counter information element**



**Annex A**  
**(informative)**

**Use of the Cause information element**

**A.1 Definition of QSIG cause Values**

**Cause No. 1 "Unallocated (unassigned) number"**

This cause indicates that the destination requested by the calling user cannot be reached because, although the number is in a valid format, it is not currently assigned (allocated).

**Cause No. 3 "No route to destination"**

This cause indicates that the called user cannot be reached because the network through which the call has been routed does not serve the desired destination.

**Cause No. 6 "Channel unacceptable"**

This cause indicates that the channel most recently identified is not acceptable to the sending entity for use in this call.

**Cause No. 16 "Normal call clearing"**

This cause indicates that one of the users involved in the call has requested that the call be cleared.

**Cause No. 17 "User busy"**

This cause is used when the user equipment is compatible with the call but called user resources are temporarily unavailable.

**Cause No. 18 "No user responding"**

This cause is used when the called user's equipment does not respond to a call establishment message with either an alerting or a connect indication within the prescribed period of time allocated.

**Cause No. 19 "No answer from user (user alerted)"**

This cause is used when a user has provided an alerting indication but has not provided a connect indication within a prescribed period of time.

**Cause No. 21 "Call rejected"**

This cause indicates that the called user does not wish to accept this call, although his equipment is neither busy nor incompatible.

**Cause No. 22 "Number changed"**

This cause is returned to a calling user when the called party number indicated by the calling user is no longer assigned. The new called party number may optionally be included in the diagnostic field. (If a network does not support this capability, Cause No. 1 shall be used).

**Cause No. 27 "Destination out of order"**

This cause indicates that the destination indicated by the user cannot be reached because the interface to the destination is not functioning correctly, i.e. a signalling message could not be delivered to the remote user (e.g. a physical layer or data link layer failure at the remote user, user equipment off-line, etc.).

**Cause No. 28 "Invalid number format (address incomplete)"**

This cause indicates that the called user cannot be reached because the called party number is not a valid format or is not complete.



**Cause No. 30 "Response to STATUS ENQUIRY"**

This cause is included in the STATUS message when the reason for generating the STATUS message was the prior receipt of a STATUS ENQUIRY message.

**Cause No. 31 "Normal, unspecified"**

This cause indicates that there is no appropriate circuit/channel presently available to handle the call.

**Cause No. 41 "Temporary failure"**

This cause indicates that the network is not functioning correctly and that the condition is not likely to last a long period of time (the user may wish to try another call attempt almost immediately).

**Cause No. 44 "Requested circuit/channel not available"**

This cause is returned when the circuit or channel indicated by the requesting entity cannot be provided by the other side of the interface / by the peer entity.

**Cause No. 57 "Bearer capability not authorized"**

This cause indicates that the user has requested a bearer capability which is implemented by the equipment generating this cause but which the user is not authorized to use.

**Cause No. 58 "Bearer capability not presently available"**

This cause indicates that the user has requested a bearer capability which is implemented by the equipment generating this cause but which is not available at this instant.

**Cause No. 63 "Service or option not available, unspecified"**

This cause is used to report a service or option not available event only when no other cause in the service or option not available class applies.

**Cause No. 65 "Bearer capability not implemented"**

This cause indicates that the equipment sending this cause does not support the bearer capability requested.

**Cause No. 81 "Invalid call reference value"**

This cause indicates that the equipment sending this cause has received a message with a call reference which is not currently in use on that particular link.

**Cause No. 88 "Incompatible destination"**

This cause indicates that the equipment sending this cause has received a request to establish a call which has LLC, HLC, or other compatibility attributes (e.g. data rate) which cannot be accommodated.

**Cause No. 96 "Mandatory information element is missing"**

This cause indicates that the equipment sending this cause has received a message which is missing an information element that must be present in order for that message to be processed.

**Cause No. 97 "Message type non-existent or not implemented"**

This cause indicates that the equipment sending this cause has received a message with a message type it does not recognize either because this is a message not defined or defined but not implemented by the equipment sending this cause.

**Cause No. 98 "Message not compatible with call state or message type non-existent or not implemented"**

This cause indicates that the equipment sending this cause has received a message which it does not recognize or which is not compatible with the call state.

**Cause No. 99 "information element non-existent or not implemented"**

This cause indicates that the equipment sending this cause has received a message which includes information elements not recognized because the information element identifier is not defined or it is defined but not implemented by the equipment sending this cause.

**Cause No. 100 "Invalid information element contents"**

This cause indicates that the equipment sending this cause has received an information element which it has implemented; however, one or more of the fields in the information element are coded in a way that has not been implemented by the equipment sending this cause.

**Cause No. 101 "Message not compatible with call state"**

This cause indicates that the equipment sending this cause has received a message which is incompatible with the call state, or a STATUS message indicating an incompatible call state.

**Cause No. 102 "Recovery on timer expiry"**

This cause indicates that a recovery procedure has been initiated on expiry of a timer .

**Cause No. 111 "Protocol error, unspecified"**

This cause is used to report a protocol error event only when no other cause in the protocol error class applies.

**A.2 Use of causes for Busy Conditions**

The following cause values are used in this Standard for busy (= congestion) cases:

- Cause 34 'no circuit/channel available' should be generated by the side (incoming or outgoing) that determines that no suitable inter-PTNX B-channel is available to establish the call;
- Cause 44 'requested circuit/channel not available' should be generated by the incoming side if it is unable to accept the particular inter-PTNX B-channel proposed by the outgoing side.

In both cases the location field should be coded 'PTN serving the local user'. This coding may be changed to 'PTN serving the remote user' when received from another private network.

Note that Cause 17 'user busy' is not generated when congestion is encountered at the Q reference point.





Annex B

(informative)

Examples of Message Sequences

B.1 Enbloc Sending

B.1.1 Successful Call Setup

Figure B.1 shows an example of the message sequences across the PTN when a call is initiated from TE A to TE B (which is free) and the called party number in the original SETUP message is complete.

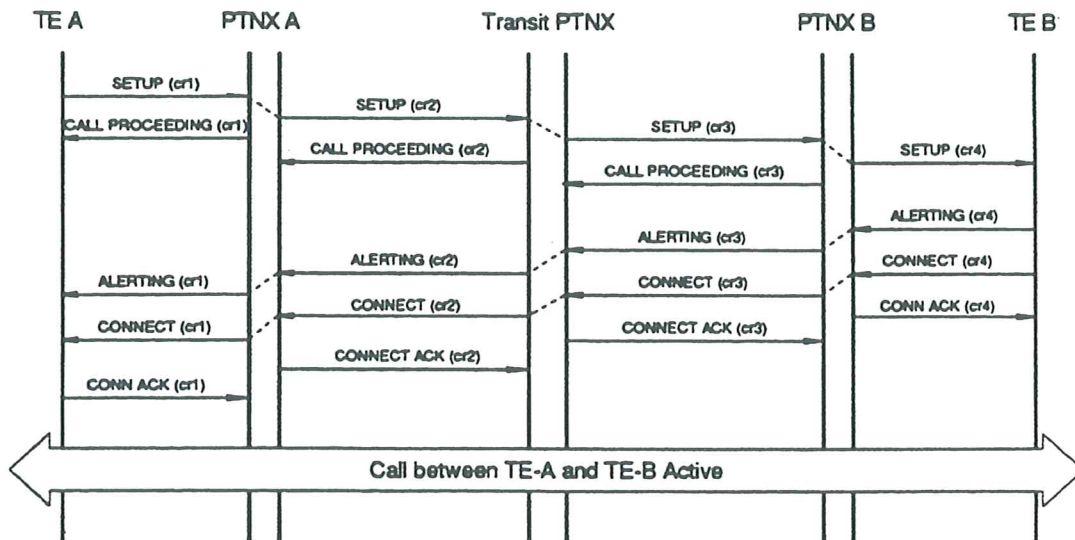

Figure B.1 - Enbloc Setup, Successful Call

B.1.2 Unsuccessful Call Setup

Figure B.2 shows an example of the message sequences across the PTN when a call is initiated from TE A to TE B (which is busy) and the called party number in the original SETUP message is complete.

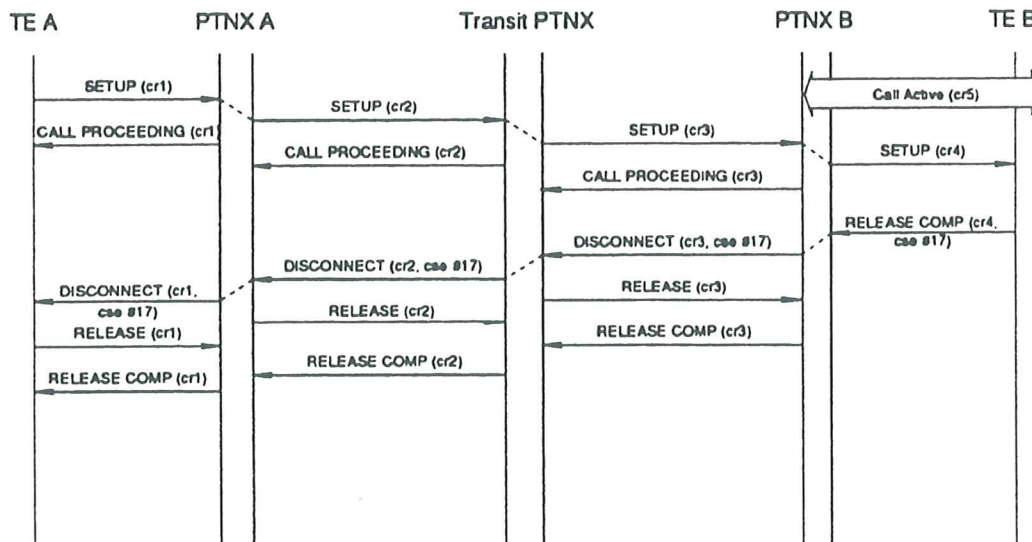
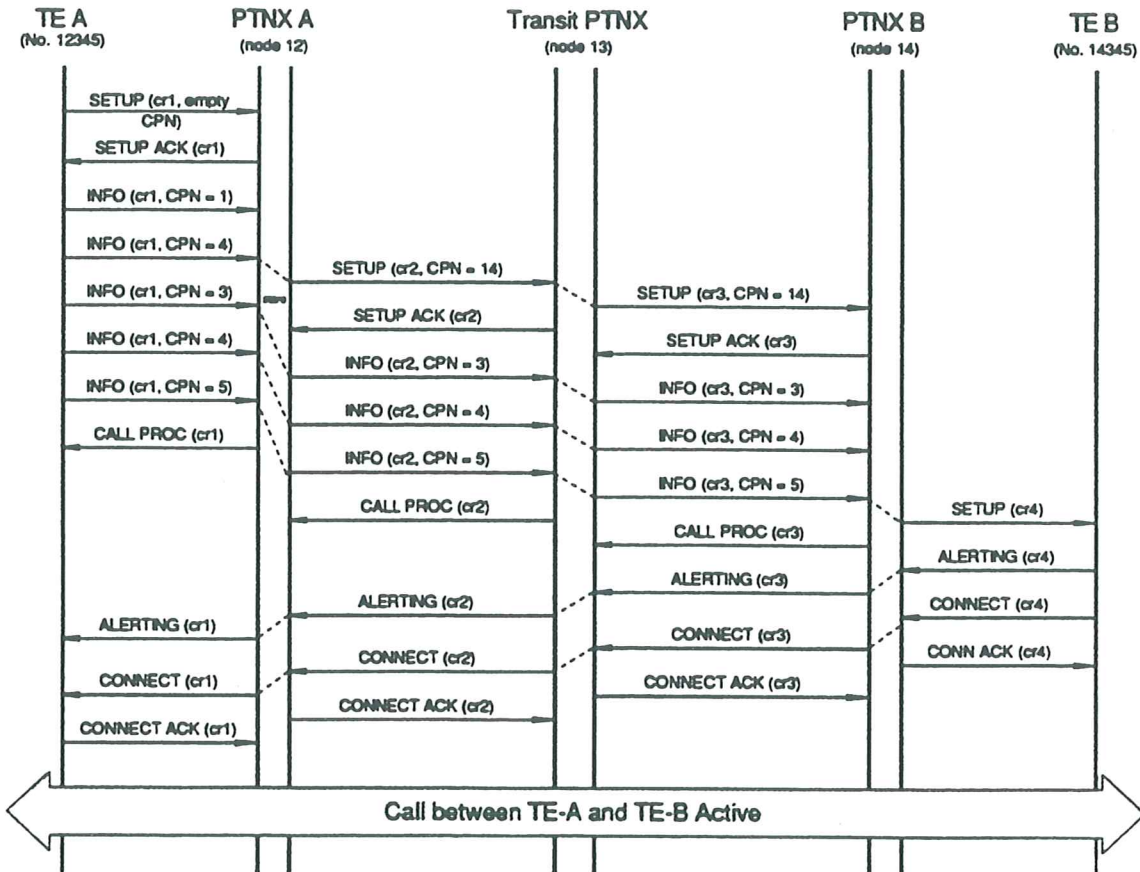

Figure B.2 - Enbloc Setup, Unsuccessful Call

**B.2 Overlap Sending**

**B.2.1 Successful Call Setup**

Figure B.3 shows an example of the message sequences across the PTN when a call is initiated from TE A to TE B (which is free) and the called party number in the original SETUP message is empty.



**Figure B.3 - Overlap Setup, Successful Call**

**B.2.2 Unsuccessful Call Setup**

Figure B.4 shows an example of the message sequences across the PTN when a call is initiated from TE A to TE B (which is busy) and the called party number in the original SETUP message is empty.

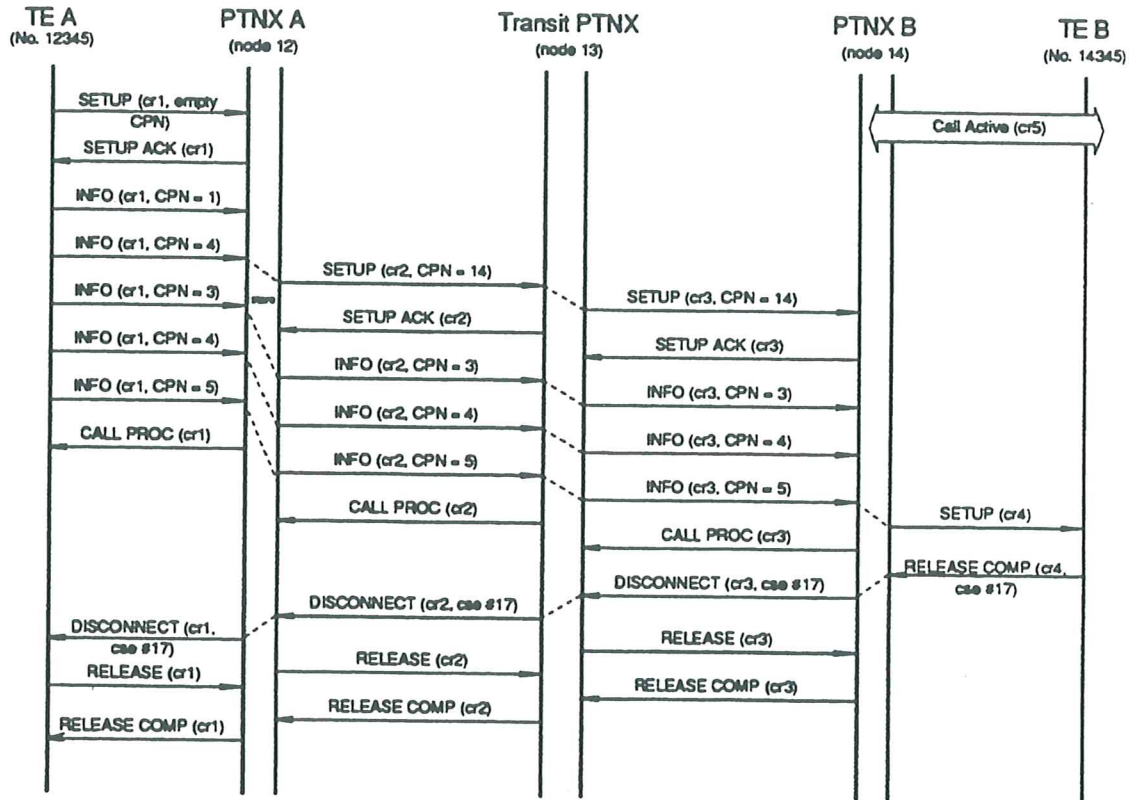

**Figure B.4 - Overlap Setup, Unsuccessful Call**



**B.3 Call Clearing**

**B.3.1 Normal Call Clearing (from originator)**

Figure B.5 shows an example of call clearing from the active state, initiated by TE A when TE A goes on hook.

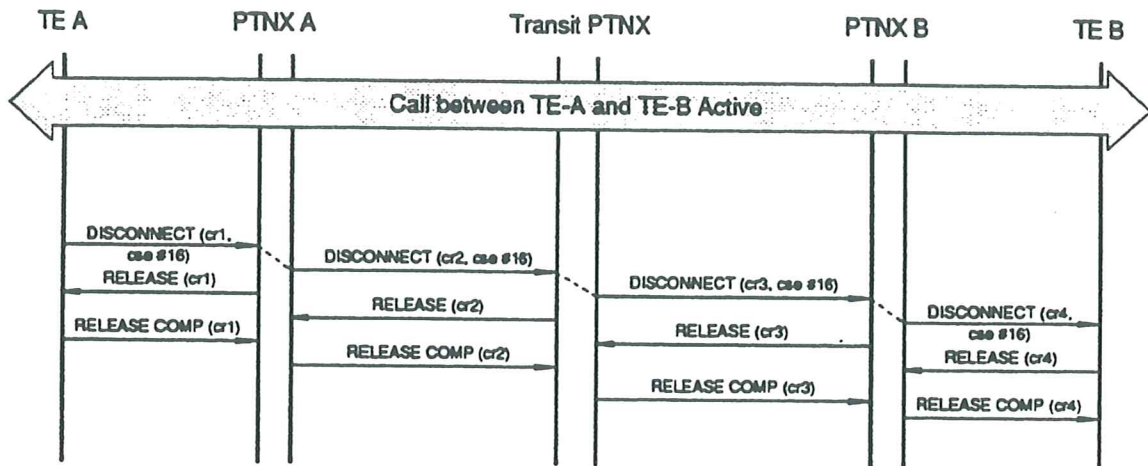

**Figure B.5 - Normal Call Clearing by Originator**

**B.3.2 Call Abort By a Transit PTNX**

Figure B.6 shows an example of a Transit PTNX aborting a call (for some reason) which is in the active state, without tones and announcements being provided. The use of Cause no. 41 "temporary failure" is shown only as an example, and is not intended to preclude the use of other cause values in this situation.

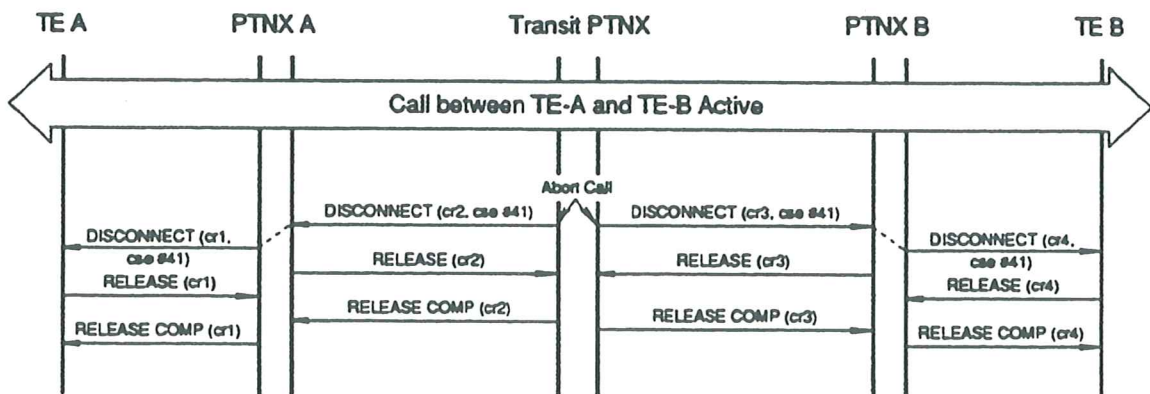

**Figure B.6 - Call Abort by Transit PTNX**

## **Annex C**

(informative)

### **Manufacturer Specific Information**

A message may include non-standardized information which is specific to a particular design of PTNX, a particular network, etc. This information is known as Manufacturer Specific Information (MSI).

The exchange of MSI between adjacent PTNXs may be achieved by means of information elements of codeset 6 or 7. The error procedures of 7.3.7 will apply in the event of an information element being received and not recognized by a PTNX. Note that ambiguity may arise when two manufacturers use the same information element identifier for different purposes.

A general purpose method of conveying MSI is by means of the Facility information element specified for supplementary services in another standard. This provides a transparent means of conveying information between adjacent or non-adjacent PTNXs (i.e. with or without intervening Transit PTNXs). It uses internationally recognized Object Identifiers to avoid ambiguity.





## Annex D

(normative)

### Protocol Implementation Conformance Statement (PICS) Proforma

#### D.1 Introduction

The supplier of a protocol implementation which is claimed to conform to this Standard shall complete the following Protocol Implementation Conformance Statement (PICS) proforma.

A completed PICS proforma is the PICS for the implementation in question. The PICS is a statement of which capabilities and options of the protocol have been implemented. The PICS can have a number of uses, including use:

- by the protocol implementor, as a check list to reduce the risk of failure to conform to the standard through oversight;
- by the supplier and acquirer, or potential acquirer, of the implementation, as a detailed indication of the capabilities of the implementation, stated relative to the common basis for understanding provided by the Standard's PICS proforma;
- by the user or potential user of the implementation, as a basis for initially checking the possibility of interworking with another implementation - while interworking can never be guaranteed, failure to interwork can often be predicted from incompatible PICSs;
- by a protocol tester, as the basis for selecting appropriate tests against which to assess the claim for conformance of the implementation.

#### D.2 Instructions for completing the PICS proforma

##### D.2.1 General structure of the PICS proforma

The PICS proforma when completed by the supplier, becomes the Protocol Implementation Conformance Statement (PICS) for the implementation.

The PICS proforma is a fixed format questionnaire divided into sub-clauses each containing a group of individual items. Each item is identified by an item number, the name of the item (question to be answered), and the reference(s) to the clause(s) that specifies (specify) the item in the main body of this Standard.

A supplier may also provide - or be required to provide - further information, categorized as either Additional Information or Exception Information. When present, each kind of further information is to be provided in a further subclause of items labelled a.<i> or x.<i> respectively for cross-referencing purposes, where i is any unambiguous identification for the item (e.g., simply a numeral); there are no other restrictions on its format and presentation.

The "Status" column indicates whether an item is applicable and if so whether support is mandatory or optional. The following terms are used:

m	mandatory (the capability is required for conformance to the protocol);
o	optional (the capability is not required for conformance to the protocol, but if the capability is implemented it is required to conform to the protocol specifications);
o.<n>	optional, but support of at least one of the group of options labelled by the same numeral <n> is required;
x	prohibited;
c.<cid>	conditional (with reference to a predicate, if the option is chosen then the subjugate condition is mandatory);
<item>	simple-predicate condition (dependent on the support marked for <item>).

Answers to the questionnaire items are to be provided either in the "Support" column, by simply marking an answer to indicate a restricted choice (Yes or No), or in the "Not Applicable" column (N/A).

**D.2.2 Additional Information**

Items of Additional Information allow a supplier to provide further information intended to assist the interpretation of the PICS. It is not intended or expected that a large quantity will be supplied, and a PICS can be considered complete without any such information. Examples might be an outline of the ways in which a (single) implementation can be set up to operate in a variety of environments and configurations.

References to items of Additional Information may be entered next to any answer in the questionnaire, and may be included in items of Exception information.

**D.2.3 Exception Information**

It may occasionally happen that a supplier will wish to answer an item with mandatory or prohibited status (after any conditions have been applied) in a way that conflicts with the indicated requirement. No pre-printed answer will be found in the Support column for this. Instead, the supplier is required to write into the support column an x.<i> reference to an item of Exception Information, and to provide the appropriate rationale in the Exception item itself.

An implementation for which an Exception item is required in this way does not conform to this Standard. A possible reason for the situation described above is that a defect in the Standard has been reported, a correction for which is expected to change the requirement not met by the implementation.

**D.3 PICS Proforma for ECMA-143**

**D.3.1 Implementation Identification**

Supplier	
Contact point for queries about the PICS	
Implementation Name(s) and Version(s)	
Other information necessary for full identification, e.g. name(s) and version(s) for machines and/or operating systems; system name(s)	

Only the first three items are required for all implementations; other information may be completed as appropriate in meeting the requirement for full identification.

The terms Name and Version should be interpreted appropriately to correspond with a suppliers terminology (e.g. Type, Series, Model).

**D.3.2 Protocol Summary**

Protocol version	First Edition
Addenda Implemented (if applicable)	
Amendments Implemented	
Have any exception items been required?	No [ ] Yes [ ] (The answer Yes means that the implementation does not conform to this Standard)

Date of Statement	
-------------------	--



**D.3.3 Bearers Supported**

Item	Question/feature	References	Status	N/A	Support
Z1	Support of the 64 kbps Unrestricted Bearer	1.2.5.5	o.1		Yes [ ] No [ ]
Z2	Support of the 64 kbps Bearer with Speech Transfer Capability	1.2.5.5	o.1		Yes [ ] No [ ]
Z3	Support of the 64 kbps Bearer with 3,1 kHz Audio Transfer Capability	1.2.5.5	o.1		Yes [ ] No [ ]

**D.3.4 General Procedures**

**D.3.4.1 Use of the Services of Layer 2**

Item	Question/feature	References	Status	N/A	Support
A1	Establishment of a Data Link Connection	7.1.1	m		Yes [ ]

**D.3.4.2 Message Segmentation Procedures**

Item	Question/feature	References	Status	N/A	Support
A2	Maximum Message Size Generated	7.2	m		Size [ ]
A3	Maximum Message Size Received	7.2	m		Size [ ]
A4	Is Length of Data Link Information Field < Max. Generated Message Size	7.2	o		Yes [ ] No [ ]
A5	Is Length of Data Link Information Field < Max. Received Message Size	7.2	o		Yes [ ] No [ ]
A6	Procedures for Messages Segmentation	7.2.1	c.1		Yes [ ] No [ ]
A7	Procedures for Messages Reassembly	7.2.2	A3.2:m	[ ]	m: Yes [ ]

c.1 If A4, then mandatory  
 else, prohibited

**D.3.4.3 Handling of Protocol Error Conditions**

Item	Question/feature	References	Status	N/A	Support
A8	Treatment of Protocol Discriminator Error	7.3.1	m		Yes [ ]
A9	Treatment of Call Reference Errors	7.3.3	m		Yes [ ]
A10	Treatment of Message Type or Sequence Errors	7.3.4	m		Yes [ ]
A11	Treatment of Information Element Errors	7.3.5 to 7.3.7	m		Yes [ ]

**D.3.4.4 Status and Status Enquiry Protocol Procedures**

Item	Question/feature	References	Status	N/A	Support
A12	Receipt of a STATUS ENQUIRY message	7.4.1	m		Yes [ ]
A13	Sending of a STATUS ENQUIRY message	7.4.1	o		Yes [ ] No [ ]
A14	Receipt of a Solicited STATUS message	7.4.2 to 7.4.2.3	c.2		Yes [ ] No [ ]
A15	Receipt of an Unsolicited STATUS message	7.4.2	m		Yes [ ]

c.2 If A13, then mandatory  
 else, optional

**D.3.5 Circuit Switched Call Control**

Item	Question/feature	References	Status	N/A	Support
B1	Is the implementation capable of functioning as an Originating PTNX?	8.7	o.2		Yes [ ] No [ ]
B2	Is the implementation capable of functioning as an Incoming Gateway PTNX?	8.9	o.2		Yes [ ] No [ ]
B3	Is the implementation capable of functioning as a Transit PTNX?	8.5	o.2		Yes [ ] No [ ]
B4	Is the implementation capable of functioning as a Terminating PTNX?	8.8	o.2		Yes [ ] No [ ]
B5	Is the implementation capable of functioning as an Outgoing Gateway PTNX?	8.10	o.2		Yes [ ] No [ ]
B6	Support Procedures for a Call Request	8.1.1	c.4	[ ]	m: Yes [ ]
B7	Does the implementation include a Sending Complete IE in every generated SETUP message?	8.1.1	c.3	[ ]	o: Yes [ ] No [ ]
B8	B-Channel Selection	8.1.2	m		Yes [ ]
B9	Overlap Receiving Procedures	8.1.3	c.5	[ ]	m: Yes [ ]
B10	Overlap Sending Procedures	8.1.3	c.6	[ ]	m: Yes [ ]
B11	Call Proceeding - Enbloc Sending (Receipt and Origination)	8.1.4/8.1.4.1	m		Yes [ ]
B12	Receipt of Call Proceeding - Overlap Receiving	8.1.4/8.1.4.2	B10:m	[ ]	m: Yes [ ]
B13	Sending of Call Proceeding - Overlap Receiving	8.1.4/8.1.4.2	B9:m	[ ]	m: Yes [ ]
B14	Support of ALERTING Origination	8.1.5	c.5	[ ]	m: Yes [ ]
B15	Support of ALERTING Termination	8.1.5	c.4	[ ]	m: Yes [ ]
B16	Support of Call Connection Procedures	8.1.6	m		Yes [ ]
B17	Sending of Call Progress Information During Call Establishment	8.1.7	c.4	[ ]	m: Yes [ ]
B18	Receipt of Call Progress Information During Call Establishment	8.1.7	m		Yes [ ]
B19	Support of Call Clearing Procedures	8.2	m		Yes [ ]
B20	Support of Call Collision Procedures	8.3	m		Yes [ ]

c.3 If B1 OR B2 OR B3, optional  
else, N/A

c.4 If B1 OR B2 OR B3, then mandatory  
else, N/A

c.5 If B3 OR B4 OR B5, then mandatory  
else, N/A

c.6 If (B1 OR B2 OR B3) AND NOT B7, then mandatory  
else, N/A



**D.3.6 Call Control at a Transit PTNX**

Item	Question/feature	References	Status	N/A	Support
C1	Call Origination/Termination Procedures	8.5.1 to 8.5.9	B3:m	[ ]	m: Yes [ ]
C2	Call Abort Procedures	8.5.10.2	B3:o	[ ]	o: Yes [ ] No [ ]
C3	Call Clearing Procedures	8.5.10.1	B3:m	[ ]	m: Yes [ ]
C4	Handling of Category 1, 2 and 3 Information Elements at a Transit PTNX	8.5.11	B3:m	[ ]	m: Yes [ ]

**D.3.7 Call Control at an Originating PTNX**

Item	Question/feature	References	Status	N/A	Support
D1	Call Origination Procedures	8.7/8.7.1 to 8.7.5	B1:m	[ ]	m: Yes [ ]
D2	Call Clearing Procedures	8.7.6	B1:m	[ ]	m: Yes [ ]

**D.3.8 Call Control at a Terminating PTNX**

Item	Question/feature	References	Status	N/A	Support
E1	Call Termination Procedures	8.8/8.8.1 to 8.8.4	B4:m	[ ]	m: Yes [ ]
E2	Call Clearing	8.8.5	B4:m	[ ]	m: Yes [ ]

**D.3.9 Call Control at an Incoming Gateway PTNX**

Item	Question/feature	References	Status	N/A	Support
F1	Establishment of a call from another network	8.9.1 to 8.9.6	B2:m	[ ]	m: Yes [ ]
F2	Call Clearing	8.9.7	B2:m	[ ]	m: Yes [ ]

**D.3.10 Call Control at an Outgoing Gateway PTNX**

Item	Question/feature	References	Status	N/A	Support
G1	Establishment of calls to another network	8.10.1 to 8.10.6	B5:m	[ ]	m: Yes [ ]
G2	Call Clearing	8.10.6	B5:m	[ ]	m: Yes [ ]

**D.3.11 Procedures for Layer Management**

Item	Question/feature	References	Status	N/A	Support
H1	Initiation of Restart Procedures - All Channels	9.1	o		Yes [ ] No [ ]
H2	Initiation of Restart Procedures - Single Channel	9.1.1	o		Yes [ ] No [ ]
H3	Receipt of RESTART - All Channels	9.1.2	m		Yes [ ]
H4	Receipt of RESTART - Single Channel	9.1.2	m		Yes [ ]
H5	Restart Procedures - Restart Collision	9.1.3	(H1 OR H2):m	[ ]	m: Yes [ ]

**D.3.12 Timers**

Item	Question/feature	References	Status	N/A	Support
I1	Implementation of T301	10	c.7	[ ]	o: Yes [ ] No [ ] Value [ ]
I2	Implementation of T302	10	c.8	[ ]	m: Yes [ ]
I3	Implementation of T303	10	c.9	[ ]	m: Yes [ ]
I4	Implementation of T304	10	B10:m	[ ]	m: Yes [ ]
I5	Implementation of T305	10/8.2.3	m		Yes [ ]
I6	Implementation of T308	10/8.2.3	m		Yes [ ]
I7	Implementation of T309	10	m		Yes [ ]
I8	Implementation of T310	10	c.10	[ ]	m: Yes [ ] o: Yes [ ] No [ ]
I9	Implementation of T313	10	c.11	[ ]	o: Yes [ ] No [ ]
I10	Implementation of T314	10/7.2.1	A5:m	[ ]	m: Yes [ ]
I11	Implementation of T316	10/9.1.1	c.12	[ ]	m: Yes [ ]
I12	Implementation of T322	10/7.4.1	A13:m	[ ]	m: Yes [ ]

c.7 If B1 OR B2 OR B3, optional  
else, N/A

c.8 If B3 OR B4 OR B5, mandatory  
else, N/A

c.9 If B1 OR B2 OR B3, mandatory  
else, N/A

c.10 If B1 OR B2, mandatory  
If B3, optional  
else, N/A

c.11 If B3 OR B4 OR B5, optional  
else, N/A

c.12 If H1 OR H2, mandatory  
else, N/A



**D.3.13 Message and Information Elements for General Procedures**

*NOTE*

*Although an implementation may be marked "yes" for questions regarding sending optional information elements, they will only be sent, for example, if they are from a terminal or preceding PTNX.*

Item	Question/feature	References	Status	N/A	Support
J1	Receipt of the messages in accordance with the procedures supported and receipt of all the permitted information elements in those messages	11	m		Yes [ ]
J2	Sending of messages, including for each message those information elements marked as mandatory for that message, in accordance with procedures supported	11	m		Yes [ ]
J3	Sending of the Channel Identification information element when mandatory in a SETUP ACKNOWLEDGE, CALL PROCEEDING, ALERTING, or CONNECT message when that message is a first response to a SETUP message	11	m		Yes [ ]
J4	Sending of a Sending Complete Information Element in an INFORMATION message when overlap sending is complete	11.2.6	o		Yes [ ] No [ ]
J5	Sending of a Progress Indicator information element in an ALERTING message (except when relaying at a Transit PTNX in accordance with C4)	11.2.1	o		Yes [ ] No [ ]
J6	Sending of a Party Category information element in an ALERTING message (except when relaying at a Transit PTNX in accordance with C4)	11.2.1	o		Yes [ ] No [ ]
J7	Sending of a Progress Indicator information element in a CONNECT message (except when relaying at a Transit PTNX in accordance with C4)	11.2.3	o		Yes [ ] No [ ]
J8	Sending of a Connected Number information element in a CONNECT message (except when relaying at a Transit PTNX in accordance with C4)	11.2.3	o		Yes [ ] No [ ]

Item	Question/feature	References	Status	N/A	Support
J9	Sending of a Connected Subaddress information element in a CONNECT message (except when relaying at a Transit PTNX in accordance with C4)	11.2.3	o		Yes [ ] No [ ]
J10	Sending of a Low Layer Compatibility information element in a CONNECT message (except when relaying at a Transit PTNX in accordance with C4)	11.2.3	o		Yes [ ] No [ ]
J11	Sending of a Party Category information element in a CONNECT message (except when relaying at a Transit PTNX in accordance with C4)	11.2.3	o		Yes [ ] No [ ]
J12	Sending of a Cause Information Element in PROGRESS message (except when relaying at a Transit PTNX in accordance with C4)	11.2.7	o		Yes [ ] No [ ]
J13	Sending of a Cause Information Element in a RELEASE or RELEASE COMPLETE message when it is not the first clearing message	11.2.8, 11.2.9	o		Yes [ ] No [ ]
J14	Sending of a Sending Complete information element in a SETUP message when enbloc sending	11.2.10	o		Yes [ ] No [ ]
J15	Sending of a Progress Indicator Information Element in a SETUP message (except when relaying at a Transit PTNX in accordance with C4)	11.2.10	o		Yes [ ] No [ ]
J16	Sending of a Calling Party Number Information Element in a SETUP message (except when relaying at a Transit PTNX in accordance with C4)	11.2.10	o		Yes [ ] No [ ]
J17	Sending of a Calling Party Subaddress Information Element in a SETUP message (except when relaying at a Transit PTNX in accordance with C4)	11.2.11	o		Yes [ ] No [ ]
J18	Sending of a Called Party Subaddress Information Element in a SETUP message (except when relaying at a Transit PTNX in accordance with C4)	11.2.11	o		Yes [ ] No [ ]

Item	Question/feature	References	Status	N/A	Support
J19	Sending of a Low Layer Compatibility Information Element in a SETUP message (except when relaying at a Transit PTNX in accordance with C4)	11.2.10	o		Yes [ ] No [ ]
J20	Sending of a High layer Compatibility Information Element in a SETUP message (except when relaying at a Transit PTNX in accordance with C4)	11.2.10	o		Yes [ ] No [ ]
J21	Sending of a Transit Counter Information Element in a SETUP message (except when relaying at a Transit PTNX in accordance with C4)	11.2.10	o		Yes [ ] No [ ]
J22	Sending of a Party Category Information Element in a SETUP message (except when relaying at a Transit PTNX in accordance with C4)	11.2.10	o		Yes [ ] No [ ]
J23	Sending of a Channel Identification Information Element in a RESTART message	11.3.1	H2:m	[ ]	m: Yes [ ]
J24	Sending of a Channel Identification Information Element in a RESTART ACKNOWLEDGE message	11.3.2	o		Yes [ ] No [ ]
J25	Message formats and codings for non-segmented messages and information elements supported	12	m		Yes [ ]
J26	Message formats and codings for segmented message types and information elements supported	12	(A4 OR A5):m	[ ]	Yes [ ]



**Annex E**

(informative)

**Relationship to ETS 300 172**

This Standard is intended to be technically aligned with ETS 300 172 with the exception of the following:

- this Standard includes a PICS proforma and a modified Conformance clause;
- this Standard has a different value range for timer T310.









