

# ECMA

Standardizing Information and Communication Systems

---

---

---

## **120 mm DVD - Read-Only Disk**

---

---



# ECMA

Standardizing Information and Communication Systems

---

---

---

## **120 mm DVD - Read-Only Disk**

---

---



## **Brief History**

ECMA Technical Committee TC31 was established in 1984 for the standardization of Optical Disks and Optical Disk Cartridges (ODC). Since its establishment, the Committee has made major contributions to ISO/IEC SC23 toward the development of International Standards for 90 mm, 120 mm, 130 mm, 300 mm, and 356 mm media. Numerous standards have been developed by TC31 and published by ECMA, almost all of which have also been adopted by ISO/IEC under the fast-track procedure as International Standards.

In February 1997 a group of ten Companies, known as the DVD Consortium, proposed to TC31 to develop an ECMA Standard for the first member of a family of 120 mm optical disks. TC31 adopted this project and started work on a first ECMA Standard for DVD - Read-Only disks. This ECMA Standard specifies the physical characteristics of such a disks which can be used for video, audio or data applications. A standard for volume and file structure common to these three types of application has been developed in ECMA Technical Committee TC15. Further work has been undertaken for a rewritable disk known as DVD-RAM, for a case for such disks, and for a writable disk DVD-R. This work is supported by nine members of the DVD Forum.

This Standard ECMA-267 specifies four Types of DVD - Read-Only disks with a nominal capacity from 4,7 Gbytes to 17,0 Gbytes. Standard ECMA-268 specifies a 80 mm DVD - Read-Only disk which differs from that of this Standard ECMA-267 only where the relevant parameters depend on the dimension of the diameter. Four Types of such DVD disks with a nominal capacity of 1,46 Gbytes to 5,32 Gbytes are specified. It is expected that corresponding International Standards will be adopted by ISO/IEC JTC1.

This ECMA Standard has been adopted by the ECMA General Assembly of December 1997.



## Table of contents

<b>Section 1 - General</b>	1
<b>1 Scope</b>	1
<b>2 Conformance</b>	1
2.1 Optical Disk	1
2.2 Generating system	1
2.3 Receiving system	1
<b>3 Reference</b>	1
<b>4 Definitions</b>	1
4.1 Adhesive layer	1
4.2 Channel bit	1
4.3 Clamping Zone	1
4.4 Digital Sum Value (DSV)	2
4.5 Disk Reference Plane	2
4.6 Dual Layer disk	2
4.7 Dummy substrate	2
4.8 Entrance surface	2
4.9 Optical disk	2
4.10 Physical sector number	2
4.11 Read-only disk	2
4.12 Recorded layer	2
4.13 Reed-Solomon code	2
4.14 Reserved field	2
4.15 Sector	2
4.16 Single Layer disk	2
4.17 Spacer	2
4.18 Substrate	2
4.19 Track	3
4.20 Track pitch	2
4.21 Zone	3
<b>5 Conventions and notations</b>	3
5.1 Representation of numbers	3
5.2 Names	3
<b>6 List of acronyms</b>	3
<b>7 General description of the disk</b>	4
<b>8 General requirements</b>	5
8.1 Environments	5
8.1.1 Test environment	5
8.1.2 Operating environment	6
8.1.3 Storage environment	6
8.1.4 Transportation	6
8.2 Safety requirements	6
8.3 Flammability	6

<b>9 Reference measurement devices</b>	6
9.1 Pick Up Head (PUH)	6
9.2 Measurement conditions	8
9.3 Normalized servo transfer function	8
9.4 Reference Servo for axial tracking	8
9.5 Reference Servo for radial tracking	9
<b>Section 2 - Dimensional, mechanical and physical characteristics of the disk</b>	10
<b>10 Dimensional characteristics (figures 5 to 8)</b>	10
10.1 Overall dimensions	11
10.2 First transition area	11
10.3 Second transition area	11
10.4 Clamping Zone	11
10.5 Third transition area	11
10.6 Information Zone	12
10.6.1 Sub-divisions of the Information Zone	12
10.6.2 Track geometry	12
10.6.3 Track modes	13
10.6.4 Channel bit length	13
10.7 Rim area	13
10.8 Remark on tolerances	13
10.9 Runout	13
10.9.1 Axial runout	13
10.9.2 Radial runout	14
10.10 Label	14
<b>11 Mechanical parameters</b>	14
11.1 Mass	14
11.2 Moment of inertia	14
11.3 Dynamic imbalance	14
11.4 Sense of rotation	14
<b>12 Optical parameters</b>	14
12.1 Index of refraction	14
12.2 Thickness of the transparent substrate	14
12.3 Thickness of the spacer of Types C and D	14
12.4 Angular deviation	14
12.5 Birefringence of the transparent substrate	15
12.6 Reflectivity	15
<b>Section 3 - Operational Signals</b>	18
<b>13 High frequency signals (HF)</b>	18
13.1 Modulated amplitude	18
13.2 Signal asymmetry	19
13.3 Cross-track signal	19
13.4 Quality of signals	19
13.4.1 Jitter	19
13.4.2 Random errors	19
13.4.3 Defects	19



<b>14 Servo signals</b>	19
14.1 Differential phase tracking error signal	20
14.2 Tangential push-pull signal	20
<b>Section 4 - Data Format</b>	22
<b>15 General</b>	22
<b>16 Data Frames</b>	22
16.1 Identification Data (ID)	23
16.2 ID Error Detection Code (IED)	24
16.3 Copyright Management Information (CPR_MAI)	24
16.4 Error Detection Code (EDC)	24
<b>17 Scrambled Frames</b>	25
<b>18 ECC Blocks</b>	25
<b>19 Recording Frames</b>	27
<b>20 Modulation</b>	28
<b>21 Physical Sectors</b>	29
<b>22 Suppress control of the d.c. component</b>	30
<b>Section 5 Format of the Information Zone(s)</b>	31
<b>23 General description of an Information Zone</b>	31
<b>24 Layout of the Information Zone</b>	31
<b>25 Physical Sector numbering</b>	32
<b>26 Lead-in Zone</b>	33
26.1 Initial Zone	34
26.2 Reference Code Zone	34
26.3 Buffer Zone 1	34
26.4 Buffer Zone 2	34
26.5 Control Data Zone	35
26.5.1 Physical format information	36
26.5.2 Disk manufacturing information	38
26.5.3 Content provider information	38
<b>27 Middle Zone</b>	37
<b>28 Lead-out Zone</b>	37
<b>Annex A - Measurement of the angular deviation <math>\alpha</math></b>	39

<b>Annex B - Measurement of birefringence</b>	41
<b>Annex C - Measurement of the differential phase tracking error</b>	45
<b>Annex D - Measurement of light reflectance</b>	49
<b>Annex E - Tapered cone for disk clamping</b>	51
<b>Annex F - Measurement of jitter</b>	53
<b>Annex G - 8-to-16 Modulation with RLL (2,10) requirements</b>	57
<b>Annex H - Burst Cutting Area (BCA)</b>	67
<b>Annex J - Transportation</b>	73
<b>Annex K - Measurement of the thickness of the spacer of Dual Layer disks</b>	75
<b>Annex L - Values to be implemented in existing and future specifications</b>	77
<b>Annex M - Note on the Reference Code</b>	81

## Section 1 - General

### 1 Scope

This ECMA Standard specifies the mechanical, physical and optical characteristics of a 120 mm, read-only optical disk to enable the interchange of such disks. It specifies the quality of the recorded signals, the format of the data and the recording method, thereby allowing for information interchange by means of such disks. This disk is identified as DVD - Read-Only Disk.

This ECMA Standard specifies

- four related but different Types of this disk (see clause 7),
- the conditions for conformance,
- the environments in which the disk is to be operated and stored,
- the mechanical and physical characteristics of the disk, so as to provide mechanical interchange between data processing systems,
- the format of the information on the disk, including the physical disposition of the tracks and sectors, the error correcting codes and the coding method used,
- the characteristics of the signals recorded on the disk, enabling data processing systems to read the data from the disk.

This ECMA Standard provides for interchange of disks between disk drives. Together with a standard for volume and file structure, it provides for full data interchange between data processing systems.

### 2 Conformance

#### 2.1 Optical Disk

A claim of conformance shall specify the Type of the disk. An optical disk shall be in conformance with this ECMA Standard if it meets the mandatory requirements specified for its Type.

#### 2.2 Generating system

A generating system shall be in conformance with this ECMA Standard if the optical disk it generates is in accordance with 2.1.

#### 2.3 Receiving system

A receiving system shall be in conformance with this ECMA Standard if it is able to handle all four Types of optical disk according to 2.1.

### 3 Reference

ECMA-129 (1994) Information Technology Equipment - Safety

### 4 Definitions

For the purpose of this ECMA Standard the following definitions apply.

#### 4.1 Adhesive layer

A layer of adhesive material bonding together the two parts of the disk.

#### 4.2 Channel bit

The elements by which, after modulation, the binary values ZERO and ONE are represented on the disk by pits.

#### 4.3 Clamping Zone

The annular part of the disk within which a clamping force is applied by a clamping device.

#### **4.4 Digital Sum Value (DSV)**

The arithmetic sum obtained from a bit stream by allocating the decimal value 1 to bits set to ONE and the decimal value -1 to bits set to ZERO.

#### **4.5 Disk Reference Plane**

A plane defined by the perfectly flat annular surface of an ideal spindle onto which the Clamping Zone of the disk is clamped, and which is normal to the axis of rotation.

#### **4.6 Dual Layer disk**

An optical disk with one or two entrance surface(s), in which each entrance surface gives access to a different pair of recorded layers.

#### **4.7 Dummy substrate**

A layer which may be transparent or not, provided for the mechanical support of the disk and/or of a recorded layer.

#### **4.8 Entrance surface**

The surface of the disk onto which the optical beam first impinges.

#### **4.9 Optical disk**

A disk that accepts and retains information in the form of pits in a recorded layer that can be read by an optical beam.

#### **4.10 Physical sector number**

A serial number allocated to physical sectors on the disk.

#### **4.11 Read-only disk**

An optical disk in which the information has been recorded when manufacturing the disk. The information cannot be modified and can only be read from the disk.

#### **4.12 Recorded layer**

A layer of the disk on, or in, which data is recorded.

#### **4.13 Reed-Solomon code**

An error detection and/or correction code for the correction of errors.

#### **4.14 Reserved field**

A field set to all ZEROS unless otherwise stated, and reserved for future standardization.

#### **4.15 Sector**

The smallest part of a track in the Information Zone that can be accessed independently of other addressable parts.

#### **4.16 Single Layer disk**

An optical disk with one or two entrance surface(s), in which each entrance surface gives access to a different recorded layer.

#### **4.17 Spacer**

In the case of Dual Layer disks, the transparent layer placed between the two recorded layers accessible through the same entrance surface.

#### **4.18 Substrate**

A transparent layer of the disk, provided for mechanical support of the recorded layer(s), through which the optical beam can access the recorded layer(s).

#### **4.19 Track**

A 360° turn of a continuous spiral.

#### **4.20 Track pitch**

The distance between the centrelines of a pair of adjacent physical tracks, measured in radial direction.

#### 4.21 Zone

An annular area of the disk.

### 5 Conventions and notations

#### 5.1 Representation of numbers

A measured value is rounded off to the least significant digit of the corresponding specified value. For instance, it implies that a specified value of 1,26 with a positive tolerance of + 0,01 and a negative tolerance of - 0,02 allows a range of measured values from 1,235 to 1,275.

Numbers in decimal notations are represented by the digits 0 to 9.

Numbers in hexadecimal notation are represented by the hexadecimal digits 0 to 9 and A to F in parentheses.

The setting of bits is denoted by ZERO and ONE.

Numbers in binary notations and bit patterns are represented by strings of digits 0 and 1, with the most significant bit shown to the left.

Negative values of numbers in binary notation are given as Two's complement.

In each field the data is recorded so that the most significant byte (MSB), identified as Byte 0, is recorded first and the least significant byte (LSB) last.

In a field of  $8n$  bits, bit  $b_{(8n-1)}$  shall be the most significant bit (msb) and bit  $b_0$  the least significant bit (lsb). Bit  $b_{(8n-1)}$  is recorded first.

#### 5.2 Names

The names of entities, e.g. specific tracks, fields, zones, etc. are given a capital initial.

### 6 List of acronyms

BCA	Burst-Cutting Area
BP	Byte Position
BPF	Band Pass Filter
CLV	Constant Linear Velocity
CPR_MAI	Copyright Management Information
DCC	DC Component (suppress control)
DL	Dual Layer
DPD	Differential Phase Detection
DSV	Digital Sum Value
ECC	Error Correction Code
EDC	Error Detection Code
EQ	Equalizer
FWHM	Full Width at Half Maximum
HF	High Frequency
ID	Identification Data
IED	ID Error Detection (code)
IR	Index of Refraction
LPF	Low-Pass Filter
LSB	Least Significant Byte
MSB	Most Significant Byte
NRZ	Non Return to Zero
NRZI	Non Return to Zero Inverted

OTP	Opposite Track Path
PBS	Polarizing Beam Splitter
PE	Phase Encoded
PI	Parity (of the) Inner (code)
PLL	Phase-Locked Loop
PO	Parity (of the) Outer (code)
PTP	Parallel Track Path
PUH	Pick-Up Head
RIN	Relative Intensity Noise
RS	Reed-Solomon (code)
RZ	Return to Zero
SL	Single Layer
SYNC Code	Synchronisation Code
lsb	least significant bit
msb	most significant bit

## 7 General description of the disk

The optical disk that is the subject of this ECMA Standard consists of two substrates bonded together by an adhesive layer, so that the recorded layers are on the inside. The centring of the disk is performed on the edge of the centre hole of the assembled disk on the side currently read. Clamping is performed in the Clamping Zone. This ECMA Standard specifies the following Types.

- Type A** consists of a substrate, a single recorded layer and a dummy substrate. The recorded layer can be accessed from one side only. The nominal capacity is 4,7 Gbytes.
- Type B** consist of two substrates, and two recorded layers. From one side of the disk, only one of these recorded layers can be accessed. The nominal capacity is 9,4 Gbytes.
- Type C** consists of a substrate, a dummy substrate and two recorded layers with a spacer between them. Both recorded layers can be accessed from one side only. The nominal capacity is 8,5 Gbytes.
- Type D** consists of two substrates, each having two recorded layers with a spacer between these two recorded layers. From one side of the disk, only one pair of recorded layers can be accessed. The nominal capacity is 17,0 Gbytes.

Figure 1 shows schematically these four Types. Types A and B are Single Layer (SL) disks and Types C and D are Dual Layer (DL) disks. The two layers of DL disks are identified as Layer 0 and Layer 1. Layer 0 is the layer nearer to the entrance surface. Types A and C are 1-sided disks, Types B and D are 2-sided disks.

In Type C the function of the adhesive layer can be provided by the spacer between the two recorded layers where Layer 1 is placed, for instance embossed, on the dummy substrate.

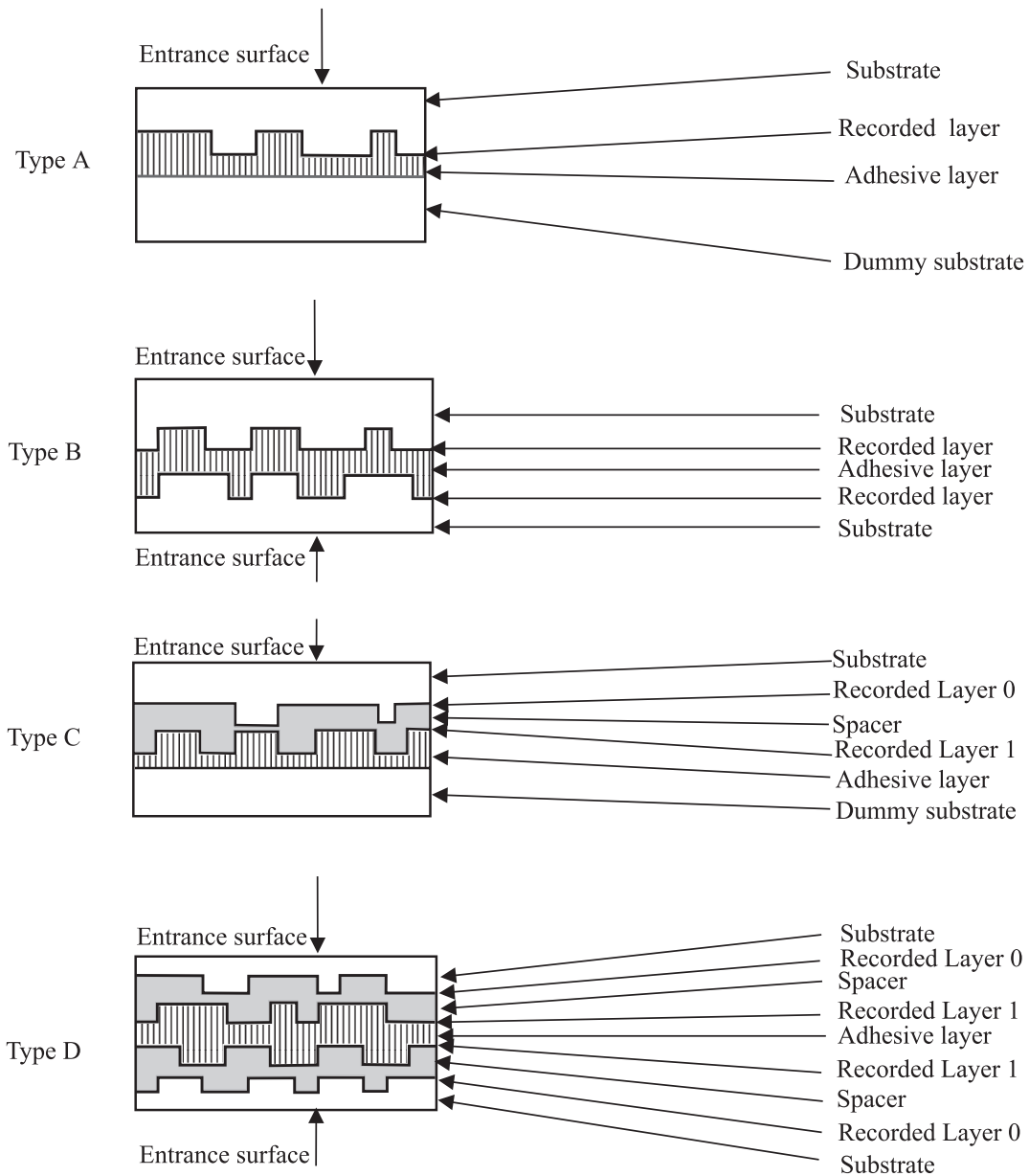

96-0236-A

**Figure 1 - Types of 120 mm DVD - Read-Only disks**

## 8 General requirements

### 8.1 Environments

#### 8.1.1 Test environment

The test environment is the environment where the air immediately surrounding the disk has the following properties.

a) For dimensional measurements

temperature : 23 °C ± 2 °C  
 relative humidity : 45 % to 55 %  
 atmospheric pressure : 86 kPa to 106 kPa

b) For other measurements

15 °C to 35 °C  
 45 % to 75 %  
 86 kPa to 106 kPa

Unless otherwise stated, all tests and measurements shall be made in this test environment.

### 8.1.2 Operating environment

This ECMA Standard requires that an optical disk which meets all mandatory requirements of this ECMA Standard in the specified test environment provides data interchange over the specified ranges of environmental parameters in the operating environment.

Disks used for data interchange shall be operated under the following conditions, when mounted in the drive supplied with voltage and measured on the outside surface of the disk.

The disk exposed to storage conditions shall be conditioned in the operating environment for at least two hours before operating.

temperature	: -25 °C to 70 °C
relative humidity	: 3 % to 95 %
absolute humidity	: 0,5 g/m <sup>3</sup> to 60 g/m <sup>3</sup>
sudden change of temperature	: 50 °C max.
sudden change of relative humidity	: 30 % max.

There shall be no condensation of moisture on the disk.

### 8.1.3 Storage environment

The storage environment is the environment where the air immediately surrounding the optical disk shall have the following properties.

temperature	: -20 °C to 50 °C
relative humidity	: 5 % to 90 %
absolute humidity	: 1 g/m <sup>3</sup> to 30 g/m <sup>3</sup>
atmospheric pressure	: 75 kPa to 106 kPa
temperature variation	: 15 °C /h max.
relative humidity variation	: 10 %/h max.

### 8.1.4 Transportation

This ECMA Standard does not specify requirements for transportation; guidance is given in annex J.

## 8.2 Safety requirements

The disk shall satisfy the requirements of Standard ECMA-129, when used in the intended manner or in any foreseeable use in an information system.

## 8.3 Flammability

The disk shall be made from materials that comply with the flammability class for HB materials, or better, as specified in Standard ECMA-129.

## 9 Reference measurement devices

The reference measurement devices shall be used for the measurements of optical parameters for conformance with this ECMA Standard. The critical components of these devices have specific properties defined in this clause.

### 9.1 Pick Up Head (PUH)

The optical system for measuring the optical parameters is shown in figure 2. It shall be such that the detected light reflected from the entrance surface of the disk is minimized so as not influencing the accuracy of measurement. The combination of the polarizing beam splitter C with the quarter-wave plate D separates the incident optical beam and the beam reflected by the optical disk F. The beam splitter C shall have a p-s intensity/reflectance ratio of at least 100. Optics G generates an astigmatic difference and collimates the light reflected by the recorded layer of the optical disk F for astigmatic focusing and read-out. The position of the quadrant photo detector H shall be adjusted so that the light spot becomes a circle the centre of which coincides with the centre of the quadrant photo detector H when the objective lens is focused on the recorded layer. An example of such a photo detector H is shown in figure 2. The dimensions *a* and *b* equal M times 10 µm to 12 µm, where M is the transversal magnification factor from the disk to its conjugate plane near the quadrant photo detector H.



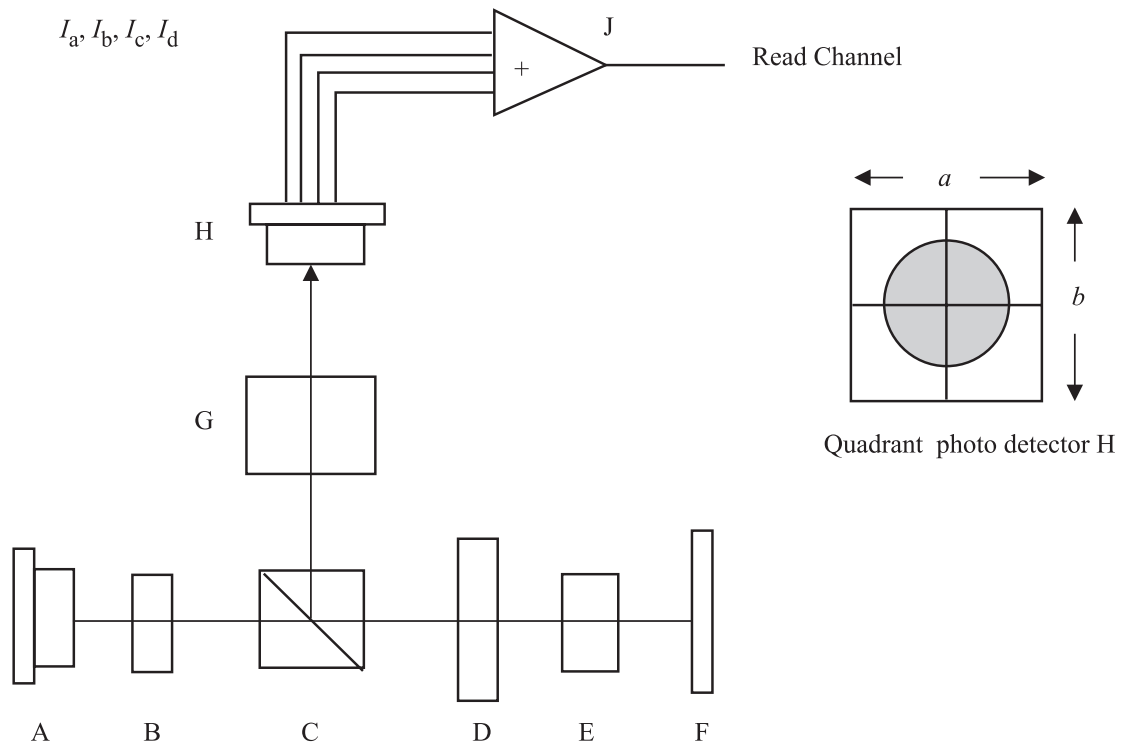

97-0019-A

A	Laser diode	F	Optical disk
B	Collimator lens	G	Optics for the astigmatic focusing method
C	Polarizing beam splitter	H	Quadrant photo detector
D	Quarter-wave plate	$I_a, I_b, I_c, I_d$	Output from the quadrant photo detector
E	Objective lens	J	d.c. coupled amplifier

**Figure 2 - Optical system for PUH**

The characteristics of the PUH shall be as follows.

Wavelength ( $\lambda$ )	650 nm $\pm$ 5 nm
Polarization	circularly polarized light
Polarizing beam splitter	shall be used unless otherwise stated
Numerical aperture	0,60 $\pm$ 0,01
Light intensity at the rim of the pupil of the objective lens	60 % to 70 % of the maximum intensity level in radial direction, and over 90 % of the maximum intensity level in tangential direction
Wave front aberration	0,033 $\lambda$ rms max.
Normalized detector size on a disk	100 $\mu\text{m}^2 < S / M^2 < 144 \mu\text{m}^2$ where S is the total surface of the photo detector of the PUH
Relative intensity noise (RIN)	- 134 dB/Hz max.
10 log [(a.c. light power density /Hz) / d.c. light power ]	

## 9.2 Measurement conditions

Scanning velocity at a Channel bit rate  
of 26,15625 Mbits/s

for Single Layer disks: 3,49 m/s  $\pm$  0,03 m/s  
for Dual Layer disks: 3,84 m/s  $\pm$  0,03 m/s

Clamping force

2,0 N  $\pm$  0,5 N

Taper cone angle

40,0°  $\pm$  0,5°, see annex E

The measuring conditions for operational signals shall be as follows.

CLV servo characteristic

$f$  (-3 dB), closed loop bandwidth : 5 Hz

Focusing method

astigmatic method

Tracking method

differential phase detection

## 9.3 Normalized servo transfer function

In order to specify the servo system for axial and radial tracking, a function  $H_s$  is used (equation I). It specifies the nominal values of the open-loop transfer function  $H$  of the Reference Servo(s) in the frequency range 23,1 Hz to 10 kHz.

$$H_s(i\omega) = \frac{1}{3} \times \left( \frac{\omega_0}{i\omega} \right)^2 \times \frac{1 + \frac{3i\omega}{\omega_0}}{1 + \frac{i\omega}{3\omega_0}} \quad (I)$$

where

$$\omega = 2\pi f$$

$$\omega_0 = 2\pi f_0$$

$$i = \sqrt{-1}$$

$f_0$  is the 0 dB crossover frequency of the open loop transfer function. The crossover frequencies of the lead-lag network of the servo are given by

$$\text{lead break frequency: } f_1 = f_0 \times 1/3$$

$$\text{lag break frequency } f_2 = f_0 \times 3$$

## 9.4 Reference Servo for axial tracking

For an open loop transfer function  $H$  of the Reference Servo for axial tracking,  $|1+H|$  is limited as schematically shown by the shaded surface of figure 3.

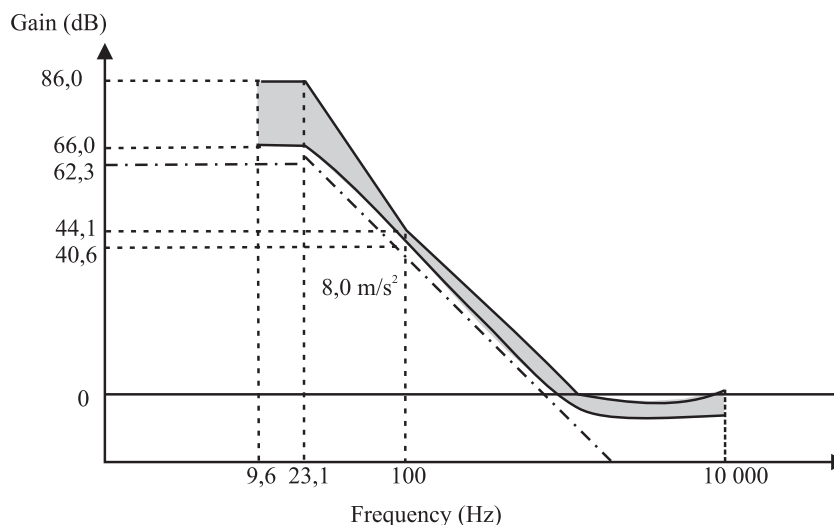

**Figure 3 - Reference Servo for axial tracking**

**Bandwidth 100 Hz to 10 kHz**

$|1 + H|$  shall be within 20 % of  $|1 + H_s|$ .

The crossover frequency  $f_0 = \omega_0 / 2\pi$  shall be specified by equation (II), where  $\alpha_{max}$  shall be 1,5 times larger than the expected maximum axial acceleration of  $8 \text{ m/s}^2$ . The tracking error  $e_{max}$  shall not exceed  $0,23 \text{ }\mu\text{m}$ . Thus the crossover frequency  $f_0$  shall be

$$f_0 = \frac{1}{2\pi} \sqrt{\frac{3 \alpha_{max}}{e_{max}}} = \frac{1}{2\pi} \sqrt{\frac{8 \times 1,5 \times 3}{0,23 \times 10^{-6}}} = 2,0 \text{ kHz} \quad \text{(II)}$$

The axial tracking error  $e_{max}$  is the peak deviation measured axially above or below the 0 level.

**Bandwidth 23,1 Hz to 100 Hz**

$|1 + H|$  shall be within the limits defined by the following four points.

- 40,6 dB at 100 Hz                    ( $|1 + H_s|$  - 20% at 100 Hz)
- 66,0 dB at 23,1 Hz                ( $|1 + H_s|$  - 20% at 23,1 Hz)
- 86,0 dB at 23,1 Hz                ( $|1 + H_s|$  - 20% at 23,1 Hz add 20 dB)
- 44,1 dB at 100 Hz                 ( $|1 + H_s|$  + 20% at 100 Hz)

**Bandwidth 9,6 Hz to 23,1 Hz**

$|1 + H|$  shall be between 66,0 dB and 86,0 dB.

**9.5 Reference Servo for radial tracking**

For an open-loop transfer function H of the Reference Servo for radial tracking,  $|1 + H|$  is limited as schematically shown by the shaded surface of figure 4.

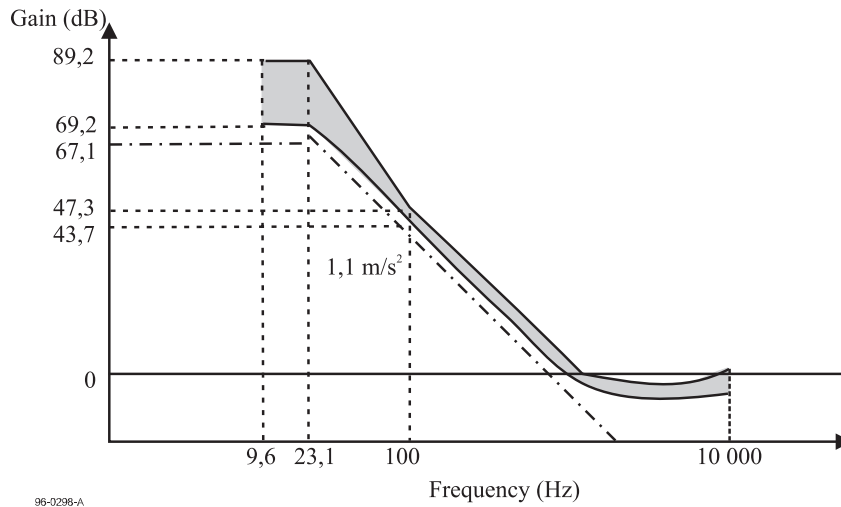

**Figure 4 - Reference Servo for Radial Tracking**

**Bandwidth from 100 Hz to 10 kHz**

$|1 + H|$  shall be within 20 % of  $|1 + H_s|$ .

The crossover frequency  $f_0 = \omega_0 / 2\pi$  shall be specified by equation (III), where  $\alpha_{max}$  shall be 1,5 times larger than the expected maximum radial acceleration of  $1,1 \text{ m/s}^2$ . The tracking error  $e_{max}$  shall not exceed  $0,022 \text{ }\mu\text{m}$ . Thus the crossover frequency  $f_0$  shall be

$$f_0 = \frac{1}{2\pi} \sqrt{\frac{3 \alpha_{max}}{e_{max}}} = \frac{1}{2\pi} \sqrt{\frac{1,1 \times 1,5 \times 3}{0,022 \times 10^{-6}}} = 2,4 \text{ kHz} \quad \text{(III)}$$

The radial tracking error is the peak deviation measured radially inwards or outwards the 0 level.

**Bandwidth from 23,1 Hz to 100 Hz**

$|1 + H|$  shall be within the limits defined by the following four points.

- 43,7 dB at 100 Hz ( $|1 + H_s|$  - 20% at 100 Hz)
- 69,2 dB at 23,1 Hz ( $|1 + H_s|$  - 20% at 23,1 Hz)
- 89,2 dB at 23,1 Hz ( $|1 + H_s|$  - 20% at 23,1 Hz add 20 dB)
- 47,3 dB at 100 Hz ( $|1 + H_s|$  + 20% at 100 Hz)

**Bandwidth from 9,6 Hz to 23,1 Hz**

$|1 + H|$  shall be between 69,2 dB and 89,2 dB.

**Section 2 - Dimensional, mechanical and physical characteristics of the disk**

**10 Dimensional characteristics (figures 5 to 8)**

Dimensional characteristics are specified for those parameters deemed mandatory for interchange and compatible use of the disk. Where there is freedom of design, only the functional characteristics of the elements described are indicated. The enclosed drawings show the dimensional requirements in summarized form. The different parts of the disk are described from the centre hole to the outside rim.

The dimensions are referred to two Reference Planes P and Q.

Reference Plane P is the primary Reference Plane. It is the plane on which the bottom surface of the Clamping Zone (see 10.4) rests.

Reference Plane Q is the plane parallel to Reference Plane P at the height of the top surface of the Clamping Zone.

### 10.1 Overall dimensions

The disk shall have an overall diameter

$$d_1 = 120,00 \text{ mm} \pm 0,30 \text{ mm}$$

The centre hole of a substrate or a dummy substrate shall have a diameter

$$d_2 = 15,00 \text{ mm} \begin{matrix} + 0,15 \text{ mm} \\ - 0,00 \text{ mm} \end{matrix}$$

The diameter of the hole of an assembled disk, i.e. with both parts bonded together, shall be 15,00 mm min., see figure 6.

There shall be no burr on both edges of the centre hole.

The edge of the centre hole shall be rounded off or chamfered. The rounding radius shall be 0,1 mm max. The chamfer shall extend over a height of 0,1 mm max.

The thickness of the disk, including adhesive layer, spacer(s) and label(s), shall be

$$e_1 = 1,20 \text{ mm} \begin{matrix} + 0,30 \text{ mm} \\ - 0,06 \text{ mm} \end{matrix}$$

### 10.2 First transition area

In the area defined by  $d_2$  and

$$d_3 = 16,0 \text{ mm min.}$$

the surface of the disk is permitted to be above Reference Plane P and/or below Reference Plane Q by 0,10 mm max.

### 10.3 Second transition area

This area shall extend between diameter  $d_3$  and diameter

$$d_4 = 22,0 \text{ mm max.}$$

In this area the disk may have an uneven surface or burrs up to 0,05 mm max. beyond Reference Planes P and/or Q.

### 10.4 Clamping Zone

This zone shall extend between diameter  $d_4$  and diameter

$$d_5 = 33,0 \text{ mm min.}$$

Each side of the Clamping Zone shall be flat within 0,1 mm. The top side of the Clamping Zone, i.e. that of Reference Plane Q shall be parallel to the bottom side, i.e. that of Reference Plane P within 0,1 mm.

In the Clamping Zone the thickness  $e_2$  of the disk shall be

$$e_2 = 1,20 \text{ mm} \begin{matrix} + 0,20 \text{ mm} \\ - 0,10 \text{ mm} \end{matrix}$$

### 10.5 Third transition area

This area shall extend between diameter  $d_5$  and diameter

$$d_6 = 44,0 \text{ mm max.}$$

In this area the top surface is permitted to be above Reference Plane Q by

$$h_1 = 0,25 \text{ mm max.}$$

or below Reference Plane Q by

$$h_2 = 0,10 \text{ mm max.}$$

The bottom surface is permitted to be above Reference Plane P by

$$h_3 = 0,10 \text{ mm max}$$

or below Reference Plane P by

$$h_4 = 0,25 \text{ mm max.}$$

## 10.6 Information Zone

The Information Zone shall extend from the beginning of the Lead-in Zone to diameter  $d_{10}$  the value of which is specified in table 1.

In the Information Zone the thickness of the disk shall be equal to  $e_1$  specified in 10.1.

### 10.6.1 Sub-divisions of the Information Zone

The main parts of the Information Zone are

- the Lead-in Zone
- the Data Zone
- the Lead-out Zone

The area extending from  $d_6$  to diameter

$$d_7 = 45,2 \text{ mm max.}$$

shall be used as follows

- it is the beginning of the Lead-in Zone for Types A and B, and each pair of layers for Type C and D in PTP mode and on Layer 0 in OTP mode,
- it is the end of the Lead-out Zone on Layer 1 for Types C and D in OTP mode.

In the first case, the Lead-in Zone shall end at diameter

$$d_8 = 48,0 \text{ mm} \begin{matrix} + 0,0 \text{ mm} \\ - 0,4 \text{ mm} \end{matrix}$$

which is the beginning of the Data Zone.

In the second case the Data Zone shall not extend toward the centre of the disk beyond  $d_8$ . The Lead-out Zone shall start after the Data Zone and end between diameters  $d_6$  and  $d_7$ .

The Data Zone shall start after the Lead-in Zone at diameter  $d_8$ , it shall extend up to diameter

$$d_9 = 116,0 \text{ mm max.}$$

The zone between diameters  $d_9$  and  $d_{10}$  constitutes the Lead-out Zone in the cases Types A and B, and Types C and D in PTP mode and the Middle Zone in the case of Types C and D in OTP mode.

The Lead-out Zone in PTP mode and the Middle Zone shall start after the Data Zone and end at diameter  $d_{10}$  the value of which depends on the length of the Data Zone as shown in table 1.

**Table 1 - End of the Information Zone**

Length of the Data Zone	Value of diameter $d_{10}$
Less than 68,0 mm	70,0 mm min.
68,0 mm to 115,0 mm	Data Zone diameter + 2,0 mm min.
115,0 mm to 116,0 mm	117,0 mm min.

The zone extending from  $d_{11}$  to  $d_{12}$  shall be used for the Burst Cutting Area, if implemented (see annex H).

### 10.6.2 Track geometry

In the Information Zone tracks are constituted by a 360° turn of a spiral.

The track pitch shall be  $0,74 \mu\text{m} \pm 0,03 \mu\text{m}$ .

The track pitch averaged over the Data Zone shall be  $0,74 \mu\text{m} \pm 0,01 \mu\text{m}$ .

### 10.6.3 Track modes

Tracks can be recorded in two different modes called Parallel Track Path (PTP) and Opposite Track Path (OTP) . Figure 5 shows examples of the PTP and OTP modes. In practice, the lengths of the Data Zones of both layers are independent from each other.

Types A and B shall be recorded in PTP mode only.

Types C and D may be recorded in either modes.

In PTP mode, tracks are read from the inside diameter of the Information Zone to its outside diameter, this applies to both Layer 0 and Layer 1 for Types C and D, see figure 5a. On both layers, the track spiral is turning from the inside to the outside.

In OTP mode, tracks are read starting on Layer 0 at the inner diameter of the Information Zone, continuing on Layer 1 from the outer diameter to the inner diameter. Thus, there is a Middle Zone at the outer diameter on both layers, see figure 5b. The track spiral is turning from the inside to the outside on Layer 0 and in the reverse direction on Layer 1.

The radial misalignment of the outer edge of the Information Zones between Layer 0 and Layer 1 shall be 0,5 mm max.

In OTP mode, the radial misalignment between the outer edge of the Data Zones of Layer 0 and Layer 1 shall be 0,5 mm max.

### 10.6.4 Channel bit length

The Information Zone shall be recorded in CLV mode. The Channel bit length averaged over the Data Zone shall be

- 133,3 nm  $\pm$  1,4 nm for Type A and Type B,
- 146,7 nm  $\pm$  1,5 nm for Type C and Type D

## 10.7 Rim area

The rim area shall be that area extending from diameter  $d_{10}$  to diameter  $d_1$  (see figure 8). In this area the top surface is permitted to be above Reference Plane Q by

$h_5 = 0,1$  mm max.

and the bottom surface is permitted to be below Reference Plane P by

$h_6 = 0,1$  mm max.

The total thickness of this area shall not be greater than 1,50 mm, i.e. the maximum value of  $e_1$ . The thickness of the rim proper shall be

$e_3 = 0,6$  mm min.

The outer edges of the disk shall be either rounded off with a rounding radius of 0,2 mm max. or be chamfered over

$h_7 = 0,2$  mm max.

$h_8 = 0,2$  mm max.

## 10.8 Remark on tolerances

All heights specified in the preceding clauses and indicated by  $h_i$  are independent from each other. This means that, for example, if the top surface of the third transition area is below Reference Plane Q by up to  $h_2$ , there is no implication that the bottom surface of this area has to be above Reference Plane P by up to  $h_3$ . Where dimensions have the same - generally maximum - numerical value, this does not imply that the actual values have to be identical.

## 10.9 Runout

### 10.9.1 Axial runout

When measured by the PUH with the Reference Servo for axial tracking, the disk rotating at the scanning velocity, the deviation of the recorded layer from its nominal position in the direction normal to the Reference Planes shall not exceed 0,3 mm.

The residual tracking error below 10 kHz, measured using the Reference Servo for axial tracking, shall be less than 0,23  $\mu\text{m}$ . The measuring filter shall be a Butterworth LPF,  $f_c$  (-3dB): 10 kHz, slope : -80 dB/decade.

#### **10.9.2 Radial runout**

The runout of the outer edge of the disk shall be less than 0,3 mm, peak-to-peak.

The radial runout of tracks shall be less than 100  $\mu\text{m}$ , peak-to-peak.

The residual tracking error below 1,1 kHz, measured using the Reference Servo for radial tracking, shall be less than 0,022  $\mu\text{m}$ . The measuring filter shall be a Butterworth LPF,  $f_c$  (-3dB) : 1,1 kHz, slope : -80 dB/decade.

The rms noise value of the residual error signal in the frequency band from 1,1 kHz to 10 kHz, measured with an integration time of 20 ms, using the Reference Servo for radial tracking, shall be less than 0,016  $\mu\text{m}$ . The measuring filter shall be a Butterworth BPF, frequency range (-3dB) : 1,1 kHz, slope :+80 dB/decade to 10 kHz, slope : - 80 dB/decade.

#### **10.10 Label**

The label shall be placed on the side of the disk opposite the entrance surface for the information to which the label is related. The label shall be placed either on an outer surface of the disk or inside the disk bonding plane. In the former case, the label shall not extend over the Clamping Zone. In the latter case, the label may extend over the Clamping Zone. In both cases, the label shall not extend over the rim of the centre hole nor over the outer edge of the disk.

### **11 Mechanical parameters**

#### **11.1 Mass**

The mass of the disk shall be in the range 13 g to 20 g.

#### **11.2 Moment of inertia**

The moment of inertia of the disk, relative to its rotation axis, shall not exceed 0,040  $\text{g}\cdot\text{m}^2$ .

#### **11.3 Dynamic imbalance**

The dynamic imbalance of the disk, relative to its rotation axis, shall not exceed 0,010  $\text{g}\cdot\text{m}$ .

#### **11.4 Sense of rotation**

The sense of rotation of the disk shall be counterclockwise as seen by the optical system.

### **12 Optical parameters**

#### **12.1 Index of refraction**

The index of refraction IR of the transparent substrate shall be  $1,55 \pm 0,10$ .

The index of refraction of the spacer shall be  $(\text{IR} \pm 0,10)$ .

#### **12.2 Thickness of the transparent substrate**

The thickness of the transparent substrate is specified as a function of its index of refraction.

Figure 9 specifies it for Types A and B and figure 10 for Types C and D.

#### **12.3 Thickness of the spacer of Types C and D**

For Types C and D, the thickness of the spacer shall be  $55 \mu\text{m} \pm 15 \mu\text{m}$ . Annex K shows two ways of measuring this thickness. On a disk, this thickness shall not vary by more than 20  $\mu\text{m}$ . Within one revolution, it shall not vary by more than 8  $\mu\text{m}$ .

#### **12.4 Angular deviation**

The angular deviation is the angle  $\alpha$  between a parallel incident beam and the reflected beam. The incident beam shall have a diameter in the range 0,3 mm to 3,0 mm. This angle includes deflection due to the entrance surface and to unparallelism of the recorded layer, see figure A.1. It shall meet the following requirements when measured according to annex A.



In radial direction :  $\alpha = 0,80^\circ$  max.

In tangential direction :  $\alpha = 0,30^\circ$  max.

### 12.5 Birefringence of the transparent substrate

The birefringence of the transparent substrate shall be 100 nm max. when measured according to annex B.

### 12.6 Reflectivity

When measured according to annex D, the reflectivity of the recorded layer(s) shall be

Types A and B : 45 % to 85 % (PUH with PBS)

Types A and B : 60 % to 85 % (PUH without PBS)

Types C and D : 18% to 30 % (PUH with PBS)

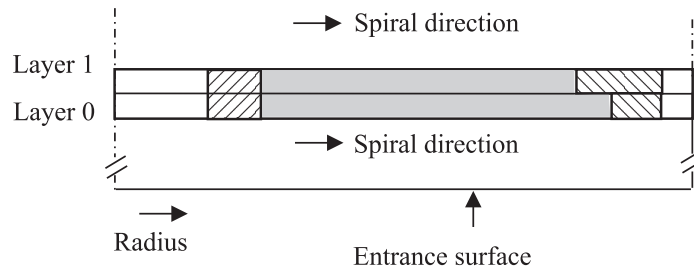

Figure 5a - Parallel Track Path (PTP)

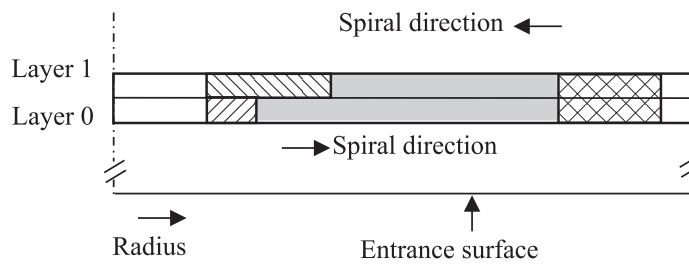
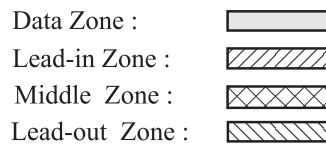

Figure 5b - Opposite Track Path (OTP)

Layer 0 = The layer closer to the entrance surface

Layer 1 = The layer farther from the entrance surface



96-0299-A

Figure 5 - Examples of track paths for Types C and D

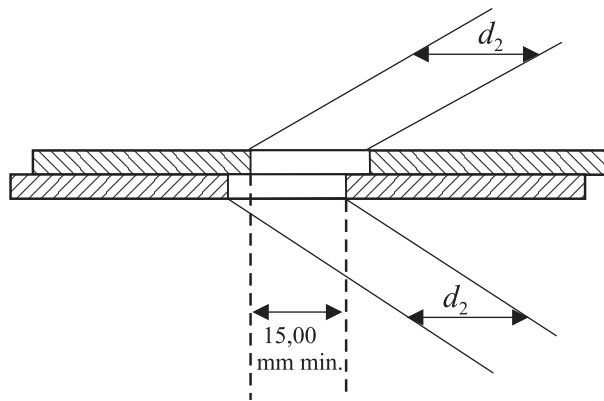

97-0001-A

Figure 6- Hole of the assembled disk

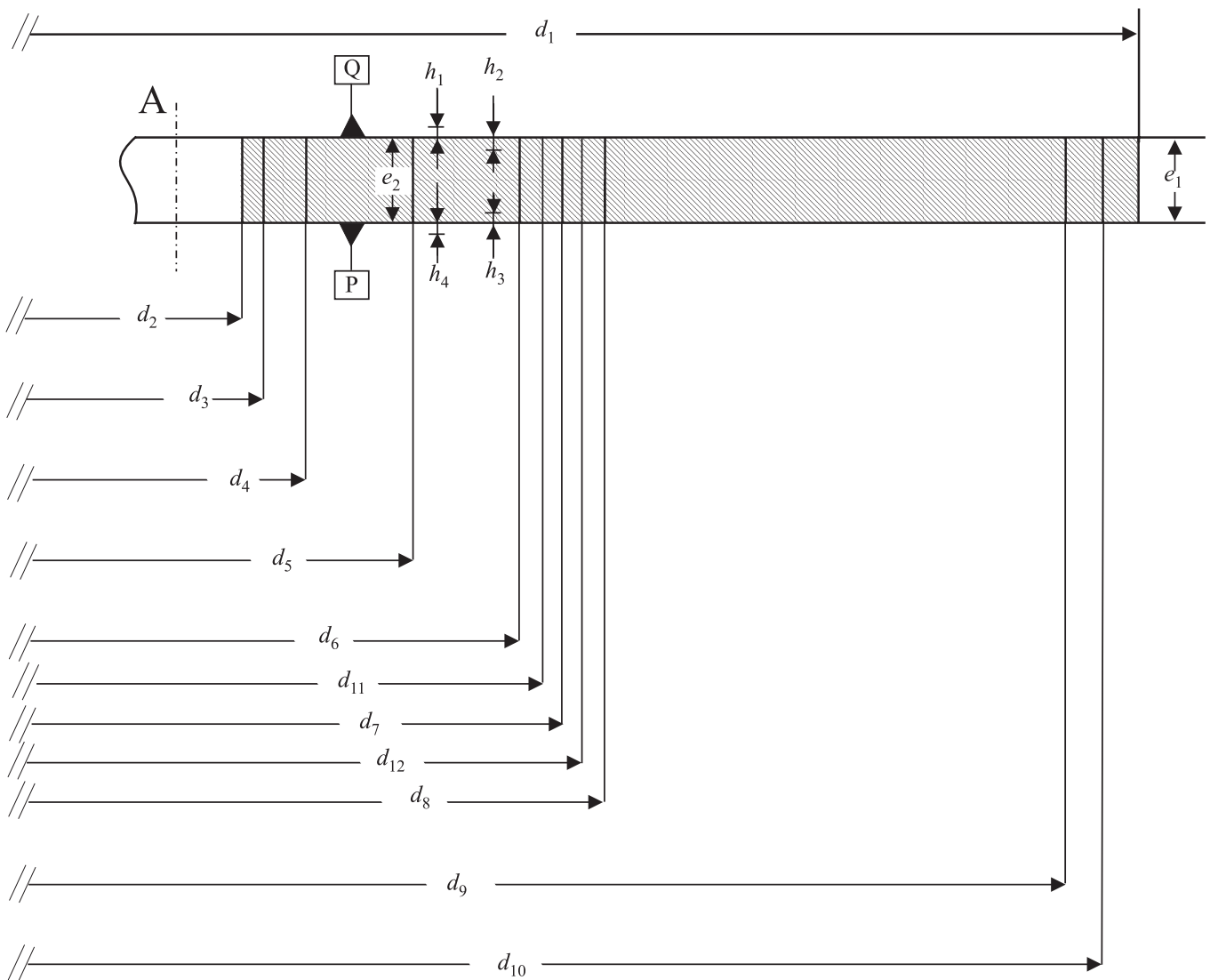

96-0291-A

Figure 7 - Areas of the disk

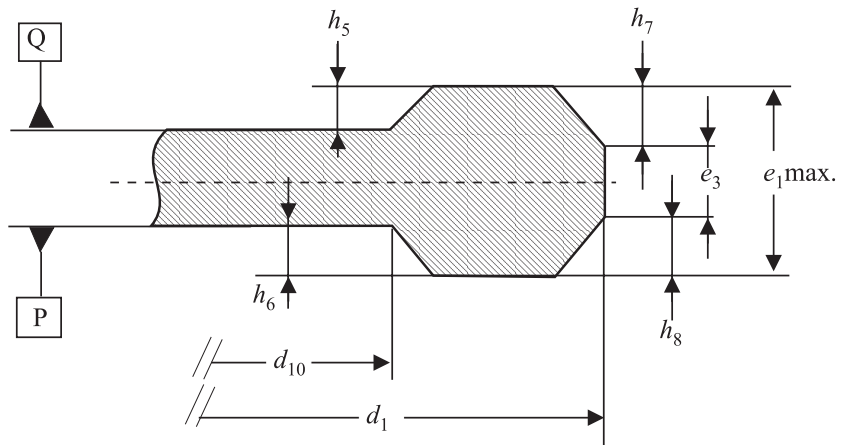

96-0292-A

Figure 8 - Rim area

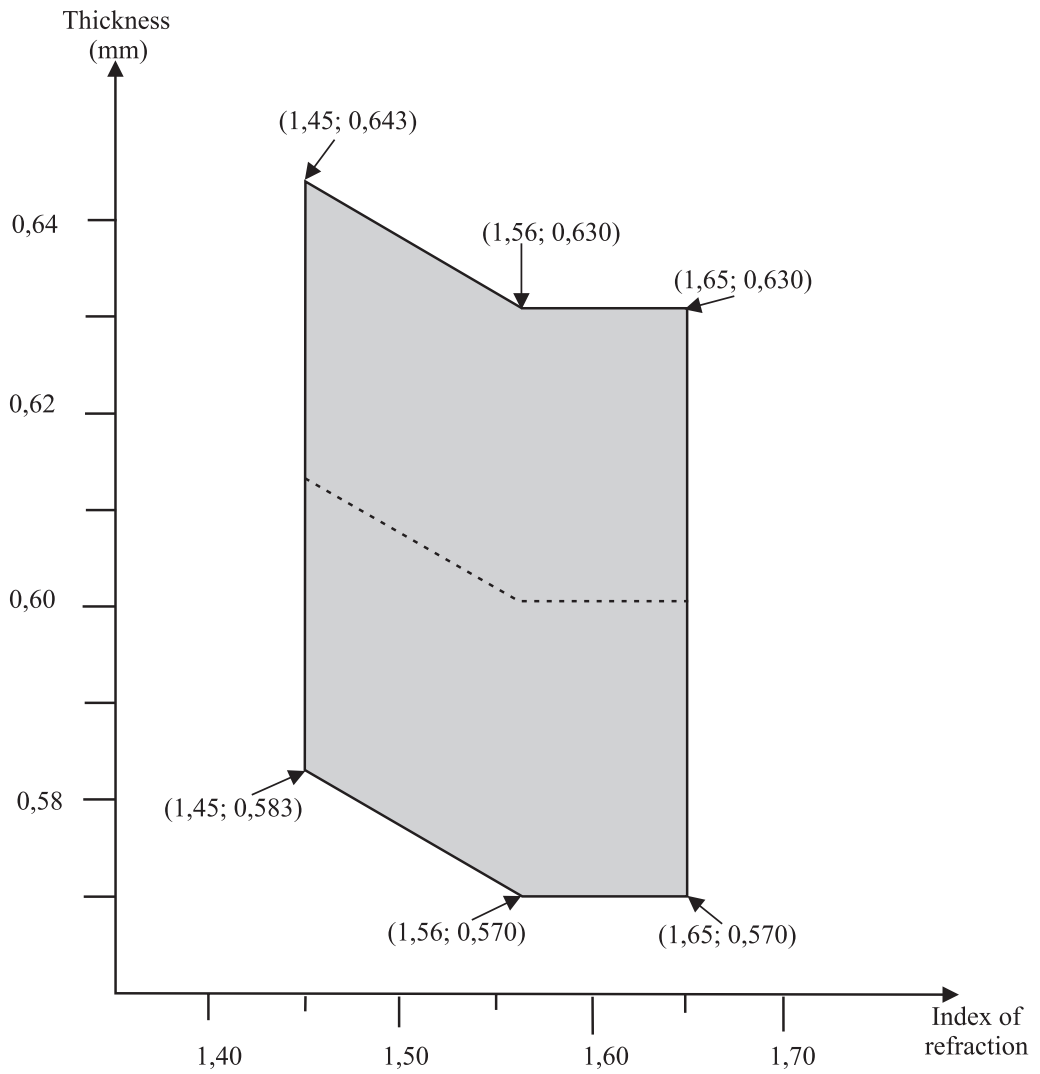

96-0300-A

Figure 9 - Thickness of the substrate for Types A and B

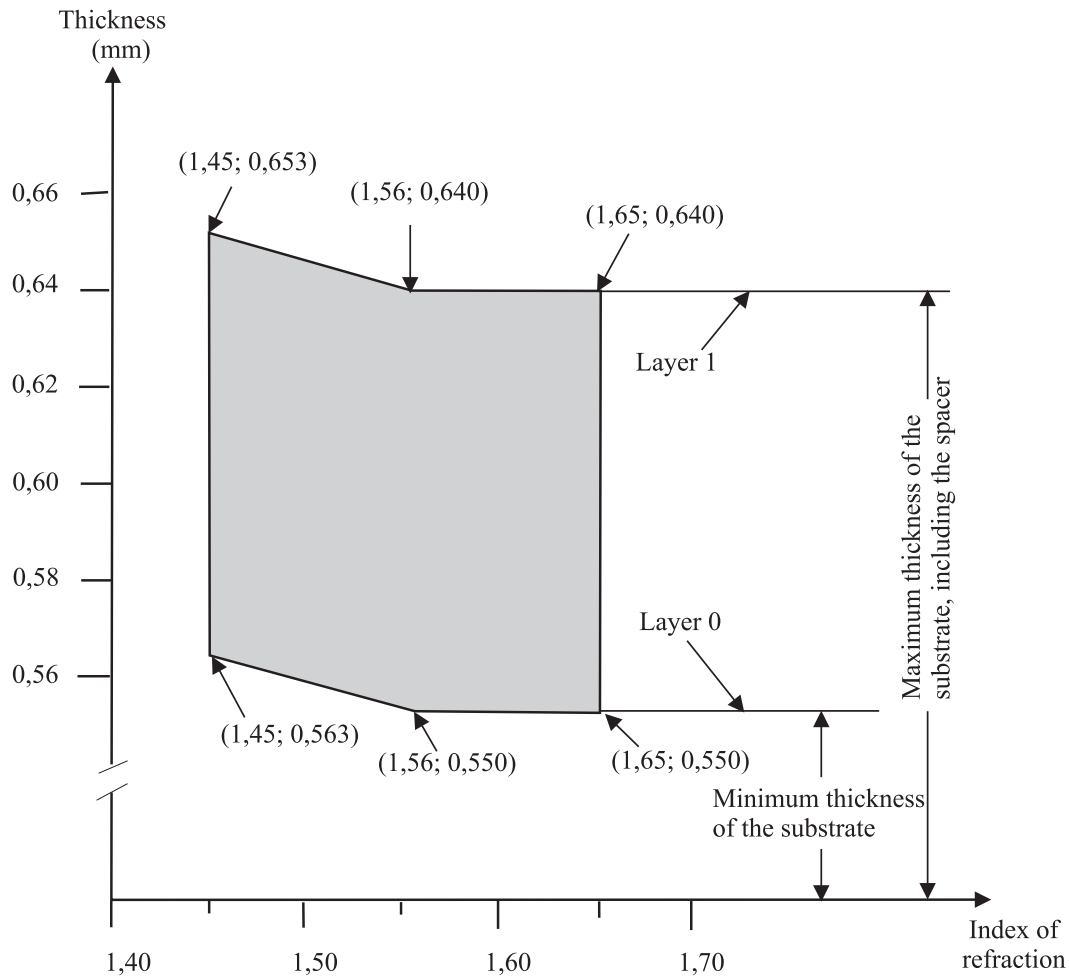

99-0301-A

**Figure 10 - Thickness of the substrate and spacer for Types C and D**

### Section 3 - Operational Signals

#### 13 High frequency signals (HF)

The HF signal is obtained by summing the currents of the four elements of the photo detector. These currents are modulated by diffraction of the light beam at the pits representing the information on the recorded layer. Measurements, except for jitter, are executed to HF before equalizing.

##### 13.1 Modulated amplitude

The modulated amplitude  $I_{14}$  is the peak-to-peak value generated by the largest pit or land length (figure 11 ).

The peak value  $I_{14H}$  shall be the peak value corresponding to the HF signal before high-pass filtering.

The peak-to-peak value of the shortest pit or land length shall be  $I_3$ .

The 0 Level is the signal level obtained from the measuring device when no disk is inserted.

These parameters shall meet the following requirements.

$$I_{14} / I_{14H} = 0,60 \text{ min.}$$

$$I_3 / I_{14} = 0,15 \text{ min. for Types A and B}$$

$$I_3 / I_{14} = 0,20 \text{ min. for Types C and D}$$

The maximum value of  $(I_{14Hmax} - I_{14Hmin}) / I_{14Hmax}$  shall be as specified by table 2.

**Table 2 - Maximum value of  $(I_{14Hmax} - I_{14Hmin}) / I_{14Hmax}$**

	<b>Within one disk</b>	<b>Within one revolution</b>
PUH with PBS	0,33	0,15
PUH without PBS with circular polarization	0,20	0,10

### 13.2 Signal asymmetry

The signal asymmetry shall meet the following requirement, see figure 11.

$$- 0,05 \leq [(I_{14H} + I_{14L}) / 2 - (I_{3H} + I_{3L}) / 2] / I_{14} \leq 0,15$$

where

- $(I_{14H} + I_{14L}) / 2$  is the centre level of  $I_{14}$
- $(I_{3H} + I_{3L}) / 2$  is the centre level of  $I_3$ .

### 13.3 Cross-track signal

The cross-track signal shall be derived from the HF signal when low-pass filtered with a cut-off frequency of 30 kHz when the light beam crosses the tracks (see figure 12). The low-pass filter is a 1st order filter. The cross-track signal shall meet the following requirements.

$$I_T = I_H - I_L$$

$$I_T / I_H = 0,10 \text{ min.}$$

where  $I_H$  is the peak value of this signal and  $I_T$  is the peak-to-peak value.

### 13.4 Quality of signals

#### 13.4.1 Jitter

Jitter is the standard deviation  $\sigma$  of the time variation of the digitized data passed through the equalizer. The jitter of the leading and trailing edges is measured to the PLL clock and normalized by the Channel bit clock period.

Jitter shall be less than 8,0 % of the Channel bit clock period, when measured according to annex F.

#### 13.4.2 Random errors

A row of an ECC Block (see clause 18) that has at least 1 byte in error constitutes a PI error. In any 8 consecutive ECC Blocks the total number of PI errors before correction shall not exceed 280.

#### 13.4.3 Defects

Defect are air bubbles and black spots. Their diameter shall meet the following requirements

- for air bubbles it shall not exceed 100  $\mu\text{m}$ ,
- for black spots causing birefringence it shall not exceed 200  $\mu\text{m}$ ,
- for black spots not causing birefringence it shall not exceed 300  $\mu\text{m}$ .

In addition, over a distance of 80 mm in scanning direction of tracks, the following requirements shall be met

- the total length of defects larger than 30  $\mu\text{m}$  shall not exceed 300  $\mu\text{m}$ ,
- there shall be at most 6 such defects.

## 14 Servo signals

The output currents of the four quadrants of the split photo detector shown in figure 13 are identified by  $I_a$ ,  $I_b$ ,  $I_c$  and  $I_d$ .

### 14.1 Differential phase tracking error signal

The differential phase tracking error signal shall be derived from the phase difference between diagonal pairs of detectors elements when the light beam crosses the tracks : Phase  $(I_a + I_c)$  - Phase  $(I_b + I_d)$  , see figure 13. The differential phase tracking error signal shall be low-pass filtered with a cut-off frequency of 30 kHz, see annex C. This signal shall meet the following requirements (see figure 14).

#### Amplitude

At the positive 0 crossing  $\overline{\Delta t}/T$  shall be in the range 0,5 to 1,1 at 0,10  $\mu\text{m}$  radial offset, where  $\overline{\Delta t}$  is the average time difference derived from the phase difference between diagonal pairs of detector elements, and T is the Channel bit clock period .

#### Asymmetry (figure 14)

The asymmetry shall meet the following requirement.

$$\frac{|T_1 - T_2|}{|T_1 + T_2|} \leq 0,2$$

where

- $T_1$  is the positive peak value of  $\overline{\Delta t}/T$
- $T_2$  is the negative peak value of  $\overline{\Delta t}/T$

### 14.2 Tangential push-pull signal

This signal shall be derived from the instantaneous level of the differential output  $(I_a + I_d) - (I_b + I_c)$ . It shall meet the following requirement, see figure15.

$$0 \leq \frac{[(I_a + I_d) - (I_b + I_c)]_{pp}}{I_{14}} \leq 0,9$$

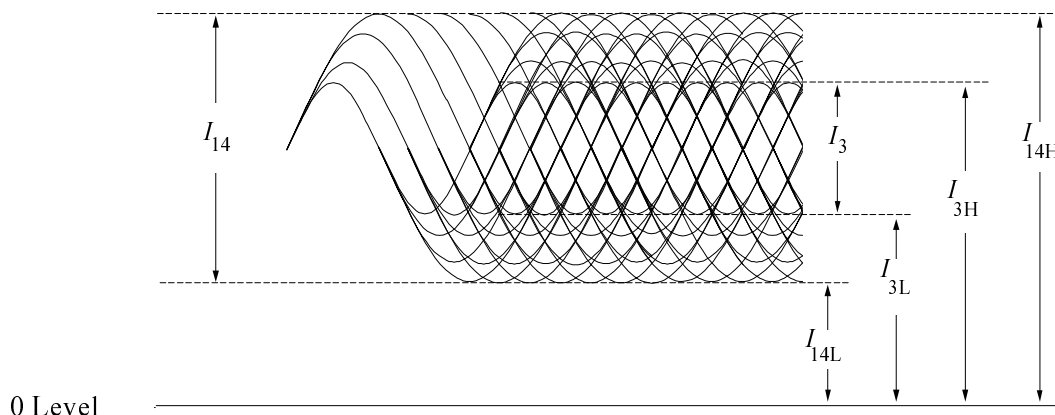

97-0002-A

Figure 11 - Modulated amplitude

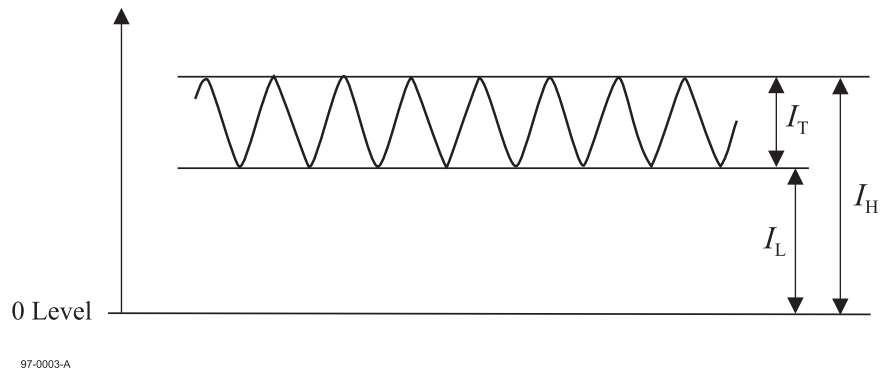

Figure 12 - Cross-track signal

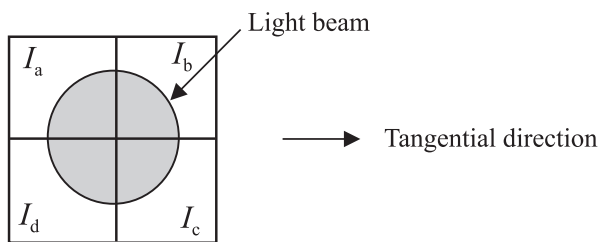

Figure 13 - Quadrant photo detector

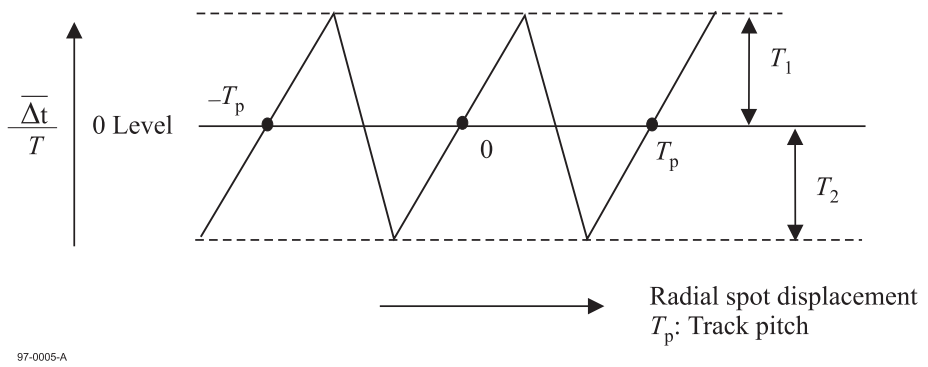

Figure 14 - Differential phase tracking error signal

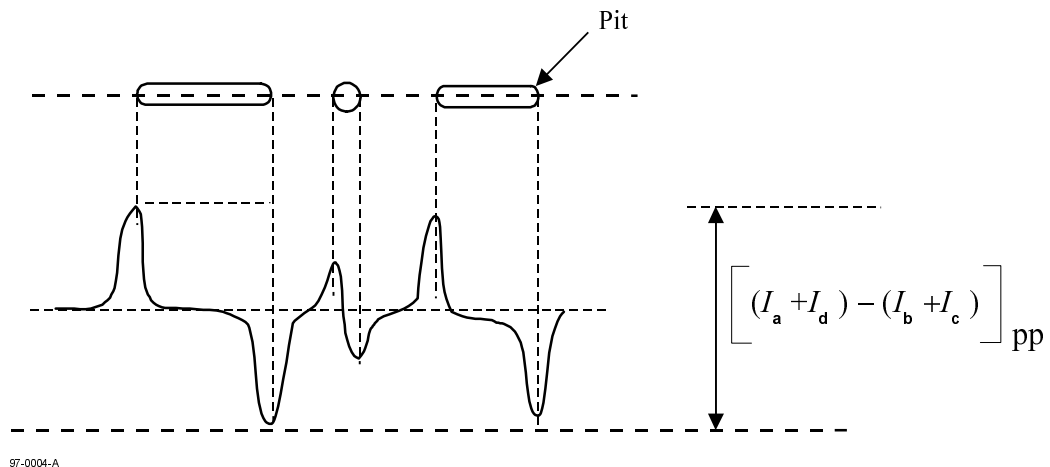

Figure 15 - Tangential push-pull signal

## Section 4 - Data Format

### 15 General

The data received from the host, called Main Data, is formatted in a number of steps before being recorded on the disk. It is transformed successively into

- a Data Frame,
- a Scrambled Frame,
- an ECC Block,
- a Recording Frame,
- a Physical Sector

These steps are specified in the following clauses.

### 16 Data Frames (figure 16)

A Data Frame shall consist of 2 064 bytes arranged in an array of 12 rows each containing 172 bytes (figure 16). The first row shall start with three fields, called Identification Data (ID), ID Error Detection Code (IED), and Copyright Management Information (CPR\_MAI), followed by 160 Main Data bytes. The next 10 rows shall each contain 172 Main Data bytes, and the last row shall contain 168 Main Data bytes followed by four bytes for recording an Error Detection Code (EDC). The 2 048 Main Data bytes are identified as  $D_0$  to  $D_{2\ 047}$ .



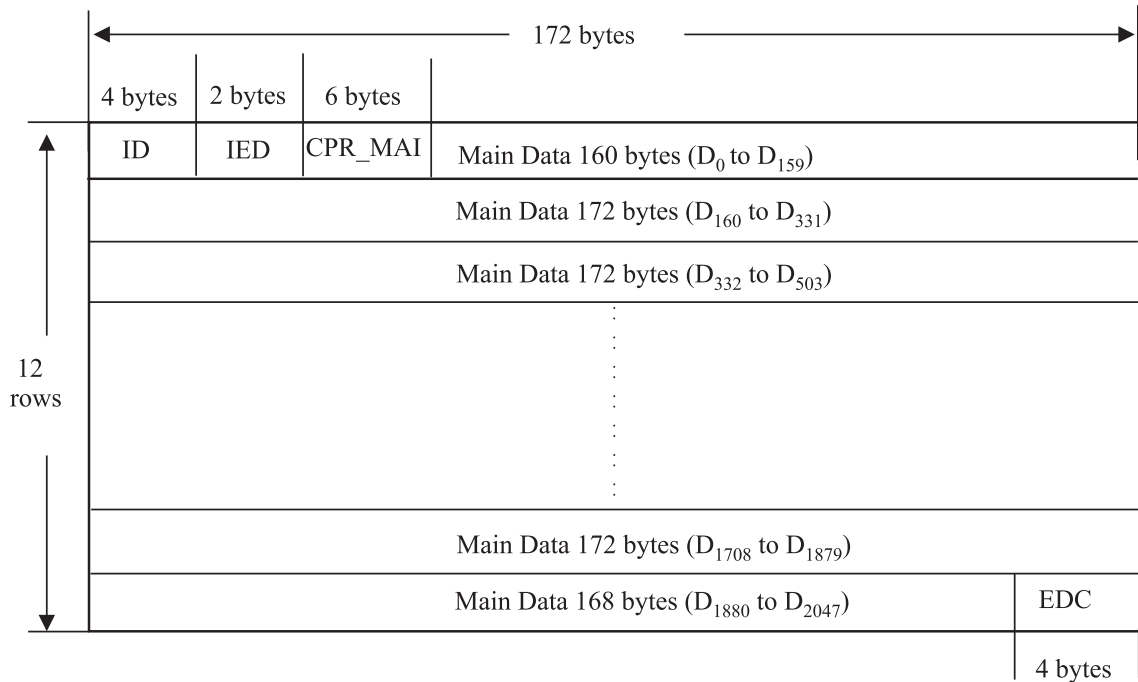

97-0020-A

**Figure 16 - Data Frame**

**16.1 Identification Data (ID)**

This field shall consist of four bytes the bits of which are numbered consecutively from  $b_0$  (lsb) to  $b_{31}$  (msb), see figure 17.

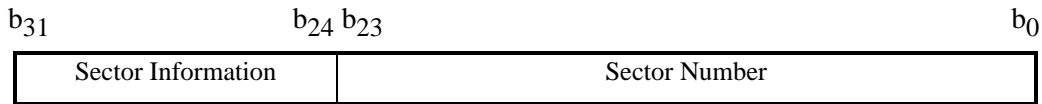

**Figure 17 - Identification Data (ID)**

$b_{31}$	$b_{30}$	$b_{29}$	$b_{28}$	$b_{27}$ and $b_{26}$	$b_{25}$	$b_{24}$
Sector Format type	Tracking method	Reflectivity	Reserved	Zone type	Data type	Layer number

**Figure 18 - Sector Information of the Identification Data (ID)**

The least significant three bytes, bits  $b_0$  to  $b_{23}$ , shall specify the sector number in binary notation. The sector number of the first sector of an ECC Block of 16 sectors shall be a multiple of 16.

The bits of the most significant byte, the Sector Information, shall be set as follows.

- Bit  $b_{24}$  shall be set to
  - ZERO on Layer 0 of DL disks
  - ONE on Layer 1 of DL disks
  - ZERO on SL disks
- Bit  $b_{25}$  shall be set to ZERO, indicating read-only data

Bits b <sub>26</sub> and b <sub>27</sub>	shall be set to ZERO ZERO in the Data Zone ZERO ONE in the Lead-in Zone ONE ZERO in the Lead-out Zone ONE ONE in the Middle Zone
Bit b <sub>28</sub>	shall be set to ZERO
Bit b <sub>29</sub>	shall be set to ZERO if the reflectivity is greater than 40 % with PBS PUH ONE if the reflectivity is 40 % max. with PBS PUH
Bit b <sub>30</sub>	shall be set to ZERO, indicating pit tracking
Bit b <sub>31</sub>	shall be set to ZERO, indicating the CLV format for read-only disks

Other settings are prohibited by this ECMA Standard, see also annex L.

### 16.2 ID Error Detection Code (IED)

When identifying all bytes of the array shown in figure 16 as C<sub>i,j</sub> for i = 0 to 11 and j = 0 to 171, the bytes of IED are represented by C<sub>0,j</sub> for j = 4 to 5. Their setting is obtained as follows.

$$IED(x) = \sum_{j=4}^5 C_{0,j} x^{5-j} = I(x) x^2 \pmod{G_E(x)}$$

where

$$I(x) = \sum_{j=0}^3 C_{0,j} x^{3-j}$$

$$G_E(x) = \prod_{k=0}^1 (x + \alpha^k)$$

$\alpha$  is the primitive root of the primitive polynomial  $P(x) = x^8 + x^4 + x^3 + x^2 + 1$

### 16.3 Copyright Management Information (CPR\_MAI)

This field shall consist of 6 bytes. Their setting is application-dependent, for instance a video application. If this setting is not specified by the application, the default setting shall be to set all bytes to all ZEROs.

### 16.4 Error Detection Code (EDC)

This 4-byte field shall contain an Error Detection Code computed over the preceding 2 060 bytes of the Data Frame. Considering the Data Frame as a single bit field starting with the most significant bit of the first byte of the ID field and ending with the least significant bit of the EDC field, then this msb will be b<sub>16 511</sub> and the lsb will be b<sub>0</sub>. Each bit b<sub>i</sub> of the EDC is as follows for i = 31 to 0 :

$$EDC(x) = \sum_{i=31}^0 b_i x^i = I(x) \pmod{G(x)}$$

where

$$I(x) = \sum_{i=16\ 511}^{32} b_i x^i$$

$$G(x) = x^{32} + x^{31} + x^4 + 1$$

## 17 Scrambled Frames

The 2 048 Main Data bytes shall be scrambled by means of the circuit shown in figure 19 which shall consist of a feedback bit shift register in which bits  $r_7$  (msb) to  $r_0$  (lsb) represent a scrambling byte at each 8-bit shift. At the beginning of the scrambling procedure of a Data Frame, positions  $r_{14}$  to  $r_0$  shall be pre-set to the value(s) specified in table 3. The same pre-set value shall be used for 16 consecutive Data Frames. After 16 groups of 16 Data Frames, the sequence is repeated. The initial pre-set number is equal to the value represented by bits  $b_7$  (msb) to bit  $b_4$  (lsb) of the ID field of the Data Frame. Table 3 specifies the initial pre-set value of the shift register corresponding to the 16 initial pre-set numbers.

**Table 3 - Initial values of the shift register**

Initial pre-set number	Initial pre-set value	Initial pre-set number	Initial pre-set value
(0)	(0001)	(8)	(0010)
(1)	(5500)	(9)	(5000)
(2)	(0002)	(A)	(0020)
(3)	(2A00)	(B)	(2001)
(4)	(0004)	(C)	(0040)
(5)	(5400)	(D)	(4002)
(6)	(0008)	(E)	(0080)
(7)	(2800)	(F)	(0005)

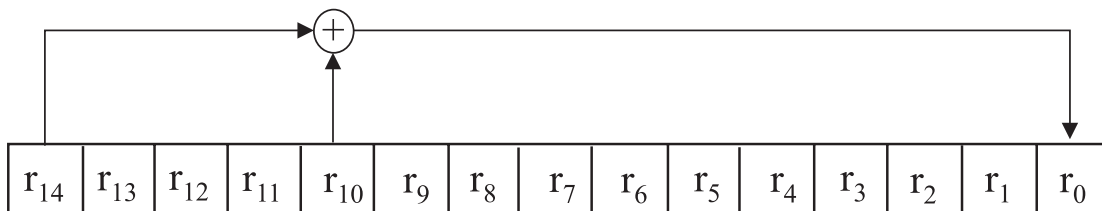

97-0021-A

**Figure 19 - Feedback shift register**

The part of the initial value of  $r_7$  to  $r_0$  is taken out as scrambling byte  $S_0$ . After that, 8-bit shift is repeated 2 047 times and the following 2 047 bytes shall be taken from  $r_7$  to  $r_0$  as scrambling bytes  $S_1$  to  $S_{2\ 047}$ . The Main Data bytes  $D_k$  of the Data Frame become scrambled bytes  $D'_k$  where

$$D'_k = D_k \oplus S_k \quad \text{for } k = 0 \text{ to } 2\ 047$$

$\oplus$  stands for Exclusive OR

## 18 ECC Blocks

An ECC Block is formed by arranging 16 consecutive Scrambled Frames in an array of 192 rows of 172 bytes each (figure 20). To each of the 172 columns, 16 bytes of Parity of Outer Code are added, then, to each of the resulting 208 rows, 10 byte of Parity of Inner Code are added. Thus a complete ECC Block comprises 208 rows of 182 bytes each. The bytes of this array are identified as  $B_{i,j}$  as follows, where  $i$  is the row number and  $j$  the column number.

$B_{i,j}$  for  $i = 0$  to  $191$  and  $j = 0$  to  $171$  are bytes from the Scrambled Frames

$B_{i,j}$  for  $i = 192$  to  $207$  and  $j = 0$  to  $171$  are bytes of the Parity of Outer Code

$B_{i,j}$  for  $i = 0$  to  $207$  and  $j = 172$  to  $181$  are bytes of the Parity of Inner Code

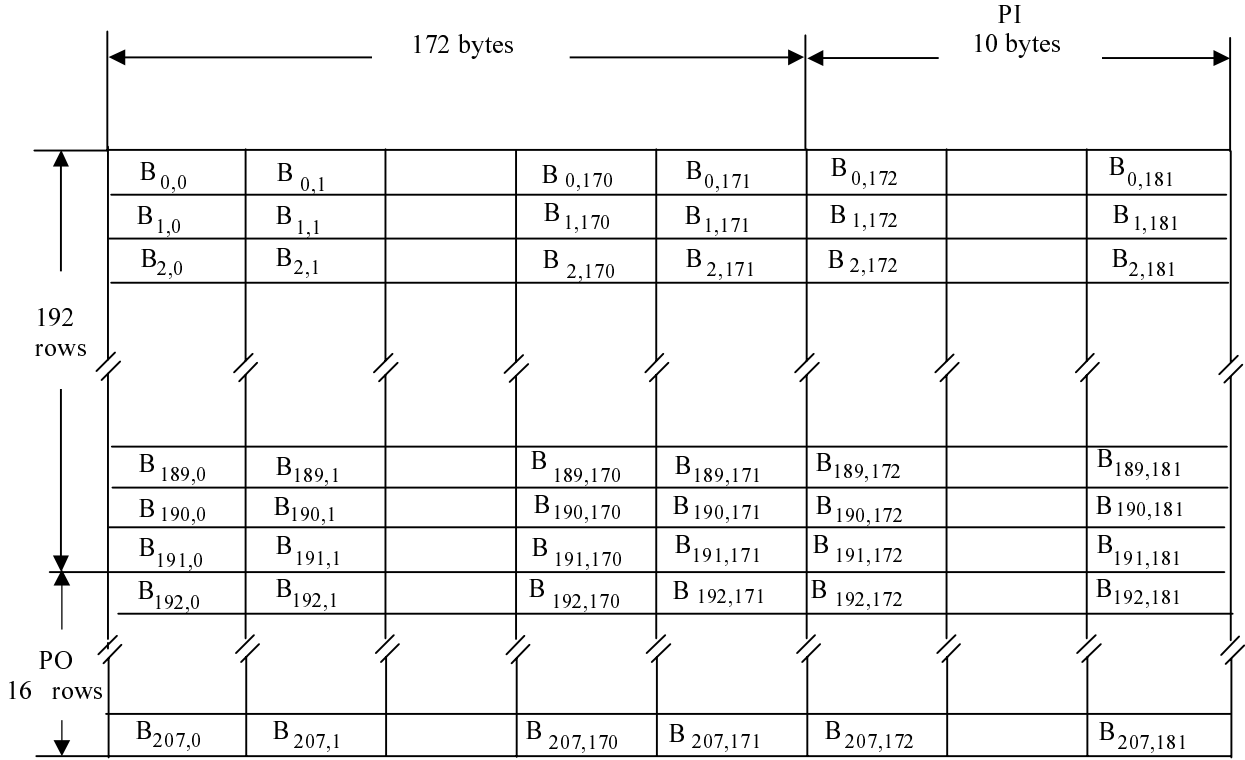

97-0022-A

**Figure 20 - ECC Block**

The PO and PI bytes shall be obtained as follows.

In each of columns  $j = 0$  to  $171$ , the 16 PO bytes are defined by the remainder polynomial  $R_j(x)$  to form the outer code RS (208,192,17).

$$R_j(x) = \sum_{i=192}^{207} B_{i,j} x^{207-i} = I_j(x) x^{16} \mod G_{PO}(x)$$

where

$$I_j(x) = \sum_{i=0}^{191} B_{i,j} x^{191-i}$$

$$G_{PO}(x) = \prod_{k=0}^{15} (x + \alpha^k)$$

In each of rows  $i = 0$  to  $207$ , the 10 PI bytes are defined by the remainder polynomial  $R_i(x)$  to form the inner code RS (182,172,11).

$$R_i(x) = \sum_{j=172}^{181} B_{i,j} x^{181-j} = I_i(x) x^{10} \mod G_{PI}(x)$$

where

$$I_i(x) = \sum_{j=0}^{171} B_{i,j} x^{171-j}$$

$$G_{PI}(x) = \prod_{k=0}^9 (x + \alpha^k)$$

$\alpha$  is the primitive root of the primitive polynomial  $P(x) = x^8 + x^4 + x^3 + x^2 + 1$

## 19 Recording Frames

Sixteen Recording Frames shall be obtained by interleaving one of the 16 PO rows at a time after every 12 rows of an ECC Block (figure 21). This is achieved by re-locating the bytes  $B_{i,j}$  of the ECC Block as  $B_{m,n}$  for

$$m = i + \text{int}[i / 12] \quad \text{and} \quad n = j \quad \text{for } i \leq 191$$

$$m = 13(i - 191) - 1 \quad \text{and} \quad n = j \quad \text{for } i \geq 192$$

where  $\text{int}[x]$  represents the largest integer not greater than  $x$ .

Thus the 37 856 bytes of an ECC Block are re-arranged into 16 Recording Frames of 2 366 bytes. Each Recording Frame consists of an array of 13 rows of 182 bytes.

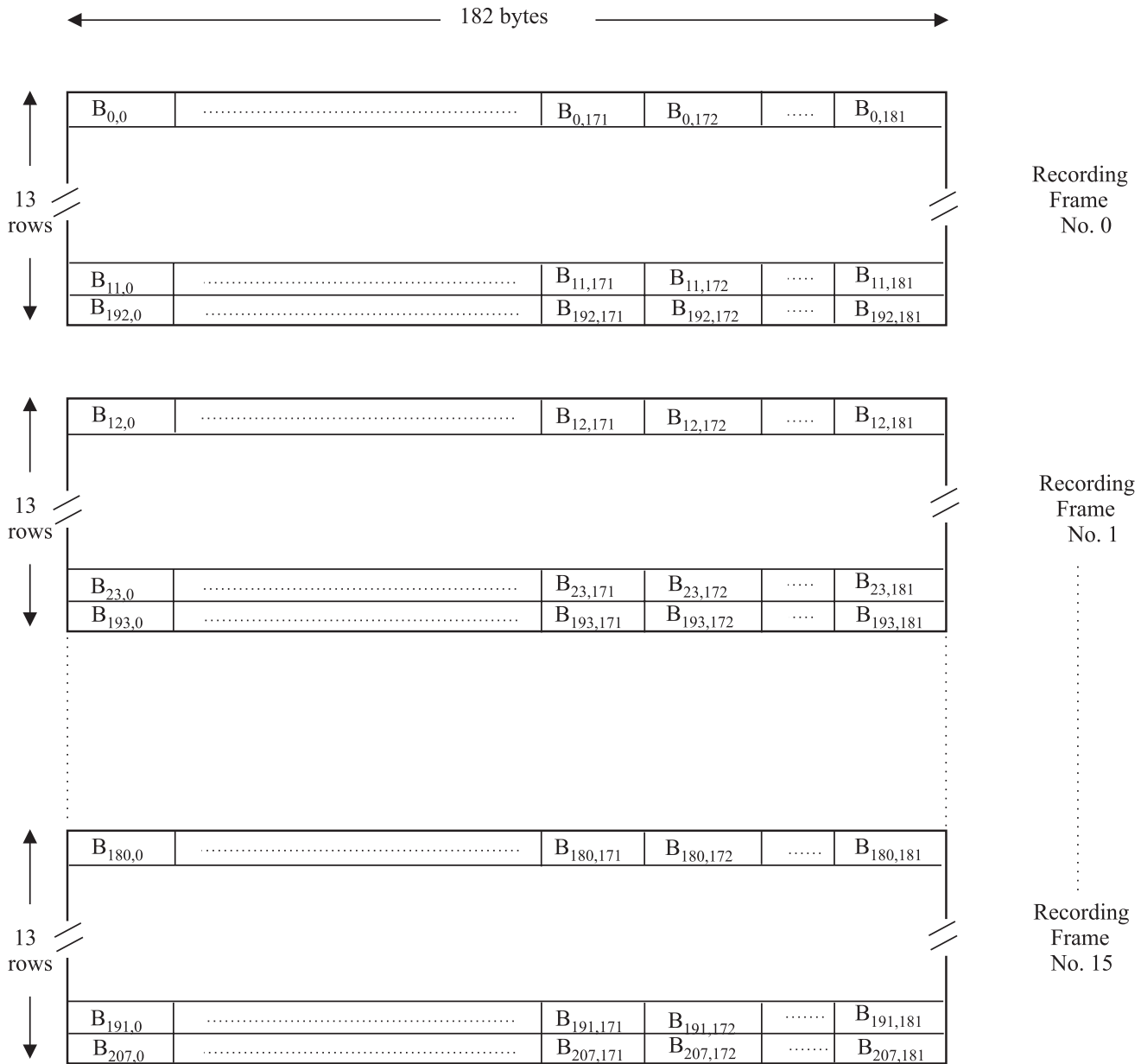

97-0023-A

**Figure 21 - Recording Frames obtained from an ECC Block**

## 20 Modulation

The 8-bit bytes of each Recording Frame shall be transformed into 16-bit Code Words with the run length limitation that between 2 ONEs there shall be at least 2 ZEROS and at most 10 ZEROS (RLL 2,10). Annex G specifies the conversion tables to be applied. The Main Conversion table and the Substitution table specify a 16-bit Code Word for each 8-bit bytes with one of 4 States. For each 8-bit byte, the tables indicate the corresponding Code Word, as well as the State for the next 8-bit byte to be encoded.

The 16-bit Code Words shall be NRZI-converted into Channel bits before recording on the disk. (figure 22).

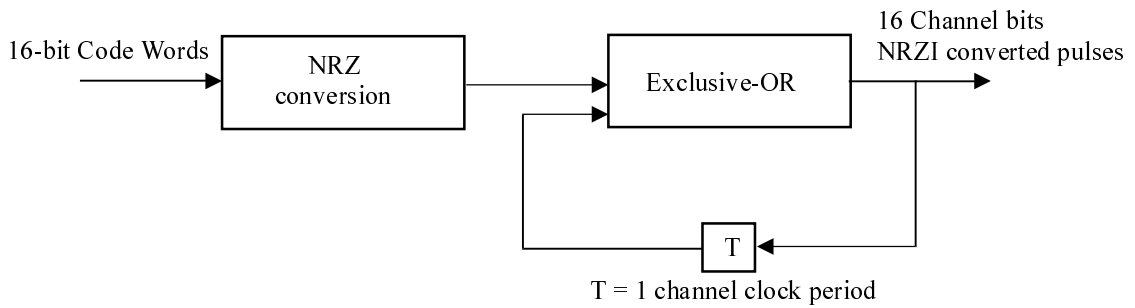

97-0024-A

**Figure 22 - NRZI conversion**

## 21 Physical Sectors

The structure of a Physical Sector is shown in figure 23. It shall consist of 13 rows, each comprising two Sync Frames. A Sync Frame shall consist of a SYNC Code from table 4 and 1 456 Channel bits representing the first, respectively the second 91 8-bit bytes of a row of a Recording Frame. The first row of the Recording Frame is represented by the first row of the Physical Sector, the second by the second, and so on.

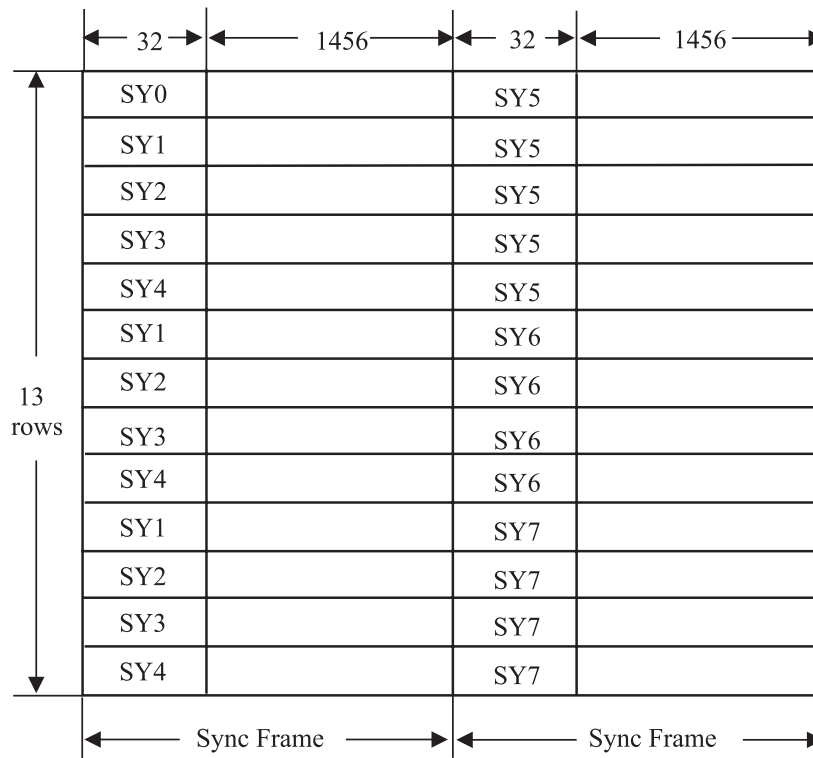

97-0025-A

**Figure 23 - Physical Sector**

Recording shall start with the first Sync Frame of the first row, followed by the second Sync Frame of that row, and so on row-by-row.

**Table 4- SYNC Codes**

State 1 and State 2			
Primary SYNC codes		Secondary SYNC codes	
(msb)	(lsb)	(msb)	(lsb)
SY0 = 0001001001000100	000000000010001	/	0001001000000100 000000000010001
SY1 = 0000010000000100	000000000010001	/	0000010001000100 000000000010001
SY2 = 0001000000000100	000000000010001	/	0001000001000100 000000000010001
SY3 = 0000100000000100	000000000010001	/	0000100001000100 000000000010001
SY4 = 0010000000000100	000000000010001	/	0010000001000100 000000000010001
SY5 = 0010001001000100	000000000010001	/	0010001000000100 000000000010001
SY6 = 0010010010000100	000000000010001	/	0010000010000100 000000000010001
SY7 = 0010010001000100	000000000010001	/	0010010000000100 000000000010001

State 3 and State 4			
Primary SYNC codes		Secondary SYNC codes	
(msb)	(lsb)	(msb)	(lsb)
SY0 = 1001001000000100	000000000010001	/	1001001001000100 000000000010001
SY1 = 1000010001000100	000000000010001	/	1000010000000100 000000000010001
SY2 = 1001000001000100	000000000010001	/	1001000000000100 000000000010001
SY3 = 1000001001000100	000000000010001	/	1000001000000100 000000000010001
SY4 = 1000100001000100	000000000010001	/	1000100000000100 000000000010001
SY5 = 1000100100000100	000000000010001	/	1000000100000100 000000000010001
SY6 = 1001000010000100	000000000010001	/	1000000001000100 000000000010001
SY7 = 1000100010000100	000000000010001	/	1000000001000100 000000000010001

**22 Suppress control of the d.c. component**

To ensure a reliable radial tracking and a reliable detection of the HF signals, the low frequency content of the stream of Channel bit patterns should be kept as low as possible. In order to achieve this, the Digital Sum Value (DSV, see 4.4) shall be kept as low as possible. At the beginning of the modulation, the DSV shall be set to 0.

The different ways of diminishing the current value of the DSV are as follows.

- a) Choice of SYNC Codes between Primary or Secondary SYNC Codes
- b) For the 8-bit bytes in the range 0 to 87, the Substitution table offers an alternative 16-bit Code Word for all States
- c) For the 8-bit bytes in the range 88 to 255, when the prescribed State is 1 or 4, then the 16-bit Code Word can be chosen either from State 1 or from State 4, so as to ensure that the RLL requirement is met.

In order to use these possibilities, two data streams, Stream 1 and Stream 2, are generated for each Sync Frame. Stream 1 shall start with the Primary SYNC Code and Stream 2 with the Secondary SYNC Code of the same category of SYNC Codes. As both streams are modulated individually, they generate a different DSV because of the difference between the bit patterns of the Primary and Secondary SYNC Codes.

In the cases b) and c), there are two possibilities to represent a 8-bit byte. The DSV of each stream is computed up to the 8-bit byte preceding the 8-bit byte for which there is this choice. The stream with the lowest |DSV| is selected and duplicated to the other stream. Then, one of the representations of the next 8-bit byte is entered into Stream 1 and the other into Stream 2. This operation is repeated each time case b) or c) occurs.

Whilst case b) always occurs at the same pattern position in both streams, case c) may occur in one of the streams and not in the other because, for instance, the next State prescribed by the previous 8-bit byte can be 2 or 3 instead of 1 or 4. In that case the following 3-step procedure shall be applied.

- 1) Compare the |DSV|s of both streams.



- 2) If the  $|DSV|$  of the stream in which case c) occurs is smaller than that of the other stream, then the stream in which case c) has occurred is chosen and duplicated to the other stream. One of the representations of the next 8-bit byte is entered into this stream and the other into the other stream.
- 3) If the  $|DSV|$  of the stream in which case c) has occurred is larger than that of the other stream, then case c) is ignored and the 8-bit byte is represented according to the prescribed State.

In both cases b) and c), if the  $|DSV|$ s are equal, the decision to choose Stream 1 or Stream 2 is implementation-defined.

The procedure for case a) shall be as follows. At the end of a Sync Frame, whether or not case b) and or case c) have occurred, the DSV of the whole Sync Frame is computed and the stream with the lower  $|DSV|$  is selected. If this DSV is greater than + 63 or smaller than -64, then the SYNC Code at the beginning of the Sync Frame is changed from Primary to Secondary or vice versa. If this yields a smaller  $|DSV|$ , the change is permanent, if the  $|DSV|$  is not smaller, the original SYNC Code is retained.

During the DSV computation, the actual values of the DSV may vary between -1000 and +1000, thus it is recommended that the count range for the DSV be at least from -1 024 to +1 023.

## Section 5 Format of the Information Zone(s)

### 23 General description of an Information Zone

The Information Zone shall be divided in three parts : the Lead-in Zone, the Data Zone and the Lead-out Zone. In SL disks and in DL disks in PTP mode there is one Information Zone per layer. In DL disks in OTP mode, there is only one Information Zone extending over two layers. In DL disks in OTP mode, the Information Zone has a Middle Zone in each layer to allow the read-out beam to move from Layer 0 to Layer 1 (see figure 5b). The Data Zone is intended for the recording of Main Data. The Lead-in Zone contains control information. The Lead-out Zone allows for a continuous smooth read-out.

### 24 Layout of the Information Zone

The Information Zone of SL disks and of DL disks in PTP mode shall be sub-divided as shown in table 5. The value of the radii indicated are the nominal values of the first track of the first Physical Sector and that of the last track of the last Physical Sector of a zone.

**Table 5 - Layout of the Information Zone**

	Nominal radius in mm			Sector Number of the first Physical Sector	Number of Physical Sectors
<b>Lead-in Zone</b> Initial Zone	22,6 max. to 24,0				
Reference Code Zone				(02F000)	32
Buffer Zone 1				(02F020)	480
Control Data Zone				(02F200)	3 072
Buffer Zone 2				(02FE00)	512
<b>Data Zone</b>	24,0 to $r_1$			(030000)	
<b>Lead-out Zone</b>	$r_1$ to 35,0 min. when $r_1 < 34,0$	$r_1$ to $(r_1+1,0)$ when $34,0 \leq r_1 \leq 57,5$	$r_1$ to 58,5 when $57,5 < r_1 < 58,0$		

## 25 Physical Sector numbering

The first Physical Sector of the Data Zone has the Sector Number (030000), it shall be recorded at the beginning of the Data Zone ( see  $d_8$  in 10.6).

On SL disks, the Sector Number of the Physical Sectors increases by 1 for each Physical Sector (figure 24).

On DL disks in PTP mode, the Sector Number of the Physical Sectors increases by 1 for each Physical Sector. The Physical Sectors are numbered in the same way on Layer 0 and on Layer 1 (figure 25).

On DL disks in OTP mode, the Sector Number of the Physical Sectors increases by 1 for each Physical Sector from (030000) to the highest Sector Number on Layer 0. The first Sector Number on Layer 1 shall be derived from this highest Sector Number by inverting its bits, viz. changing from ZERO to ONE and vice versa. Further Sector Numbers on Layer 1 increase by 1 for each Physical Sector (figure 26). The Physical Sector chosen to be that with the highest Sector Number in the Data Zone on Layer 0 shall be such that the inverted value of its Sector Number is a multiple of 16.

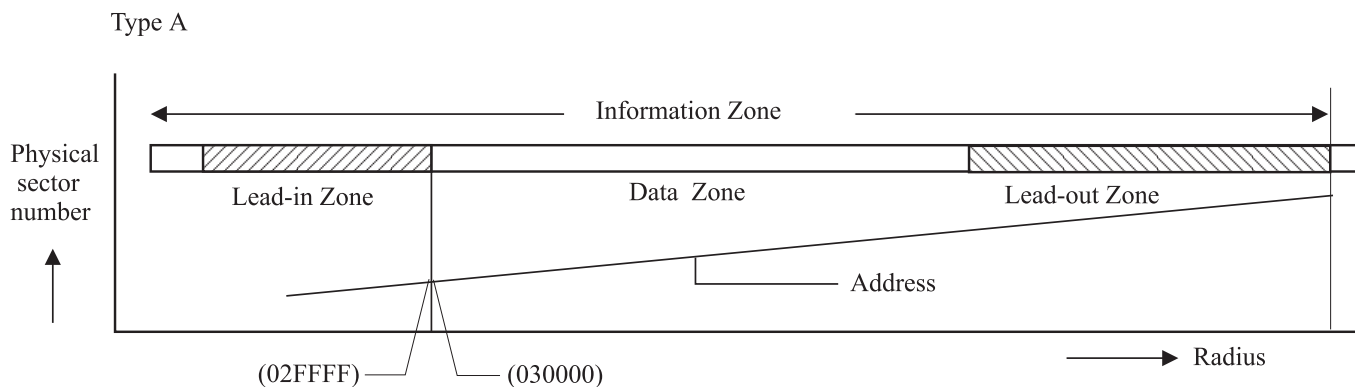

97-0026-A

**Figure 24 - Physical Sector numbering on Type A**

For Type B, the same structure applies on each side of the disk.

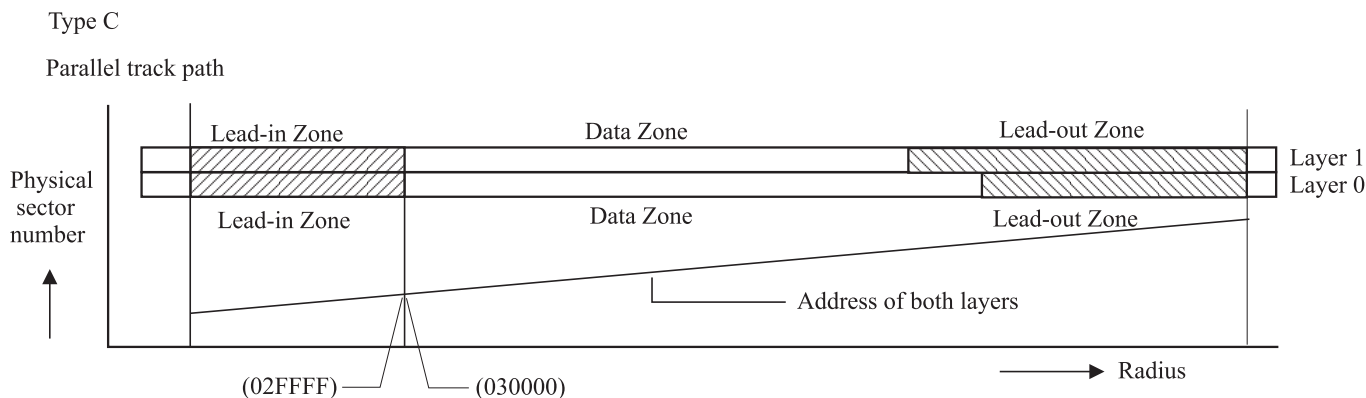

97-0027-A

**Figure 25 - Physical Sector numbering on Type C in PTP mode**

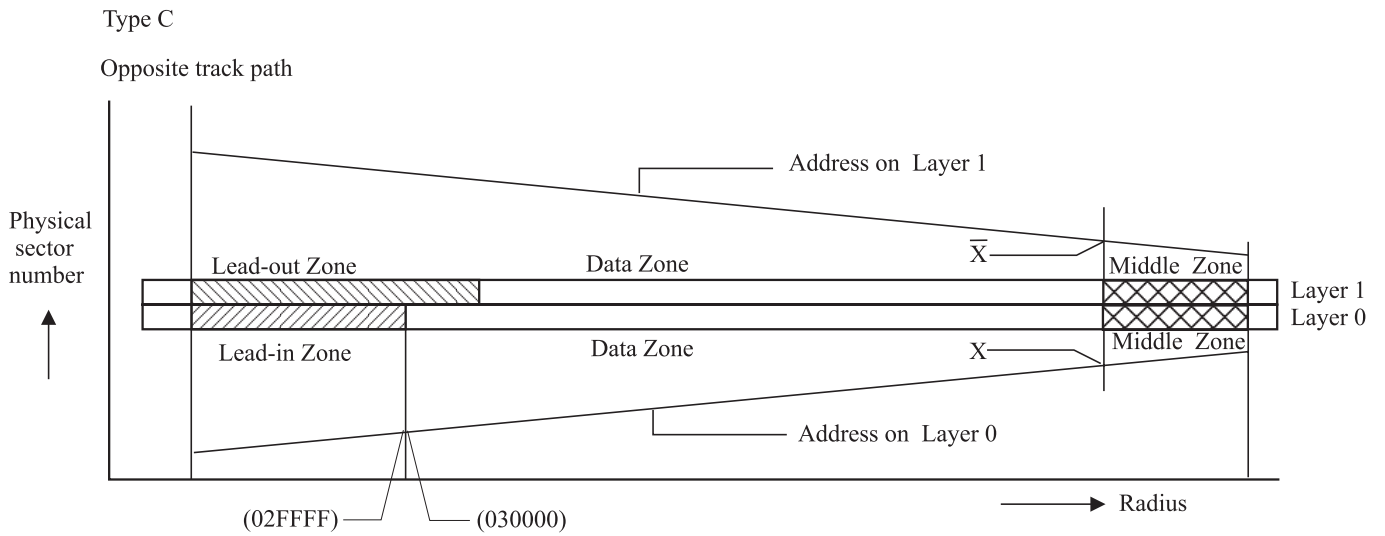

97-0028-A

**Figure 26- Physical Sector numbering on Type C in OTP mode**

For Type D, the same structures apply on each side of the disk.

## 26 Lead-in Zone

The Lead-in Zone is the innermost zone of the Information Zone. It shall consist of the following parts (figure 27). The Sector Number of the first Physical Sector of each part is indicated in figure 27 in hexadecimal and in decimal notation.

- Initial Zone,
- Reference Code Zone,
- Buffer Zone 1,
- Control Data Zone,
- Buffer Zone 2.

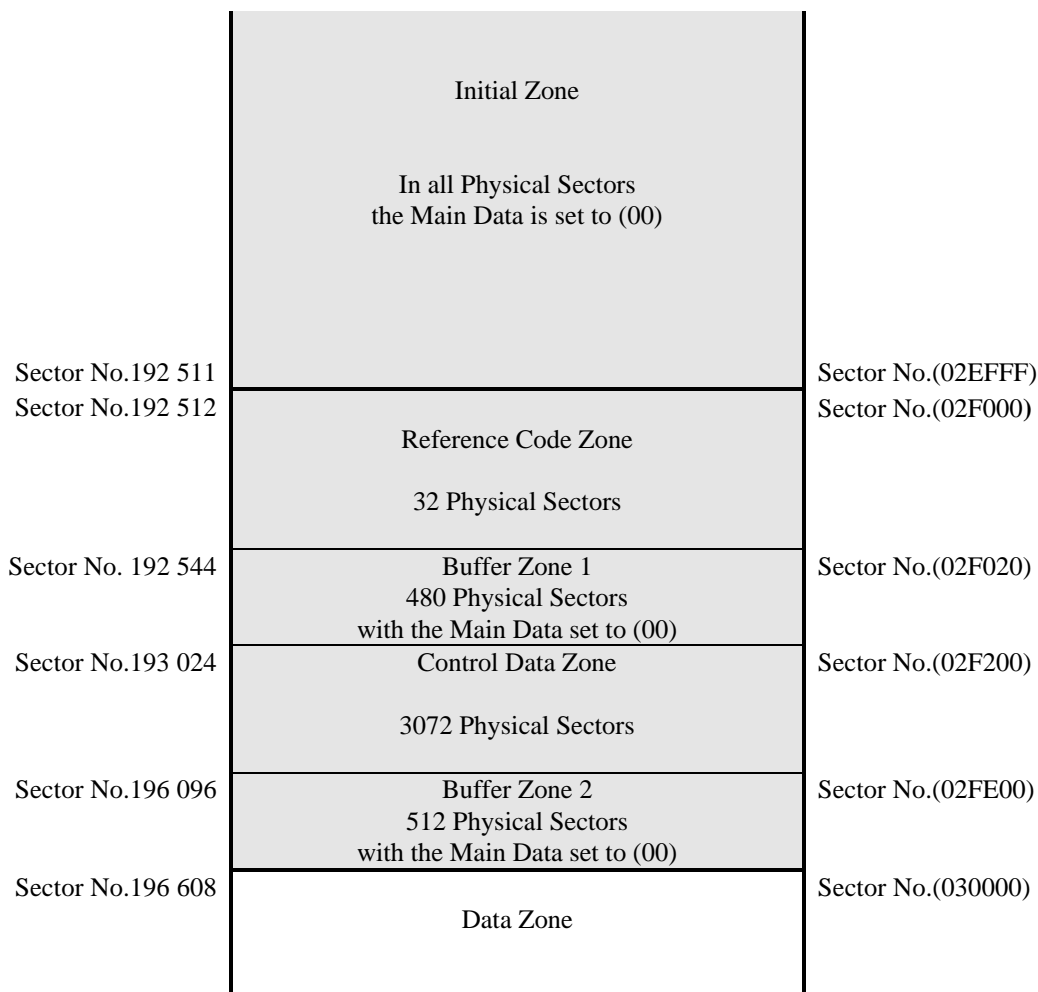

**Figure 27 - Lead-in Zone**

**26.1 Initial Zone**

The Main Data of the Data Frames eventually recorded as Physical Sectors in the Initial Zone shall have been set to (00). This ECMA Standard does not specify the number of Physical Sectors in the Initial Zone. However, the Sector Number of the first Physical Sector of the Data Zone is large enough so as to prevent a Sector Number 0 to occur in the Initial Zone.

**26.2 Reference Code Zone**

The Reference Code Zone shall consist of the 32 Physical Sectors from two ECC Blocks which generate a specific Channel bit pattern on the disk. This shall be achieved by setting to (AC) all 2 048 Main Data bytes of each corresponding Data Frame. Moreover, no scrambling shall be applied to these Data Frames, except to the first 160 Main Data bytes of the first Data Frame of each ECC Block (see also annex M).

**26.3 Buffer Zone 1**

This zone shall consist of 480 Physical Sectors from 30 ECC Blocks. The Main Data of the Data Frames eventually recorded as Physical Sectors in this zone shall have been set to (00).

**26.4 Buffer Zone 2**

This zone shall consist of 512 Physical Sectors from 32 ECC Blocks. The Main Data of the Data Frames eventually recorded as Physical Sectors in this zone shall have been set to (00).

**26.5 Control Data Zone**

This zone shall consist of 3 072 Physical Sectors from 192 ECC Blocks. The content of the 16 Physical Sectors of each ECC Block is repeated 192 times. The structure of a Control Data Block shall be as shown in figure 28.

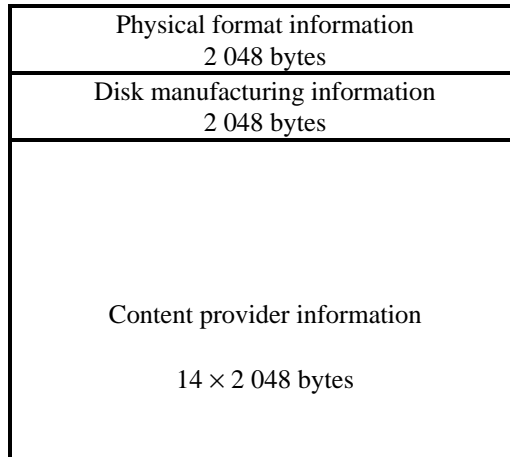

**Figure 28 - Structure of a Control Data Block**

**26.5.1 Physical format information**

This information shall comprise the 2 048 bytes shown in table 6 and described below.

**Table 6 - Physical format information**

Byte number	Content	Number of bytes
0	Disk Category and Version Number	1
1	Disk size and maximum transfer rate	1
2	Disk structure	1
3	Recording density	1
4 to 15	Data Zone allocation	12
16	BCA descriptor	1
17 to 31	Reserved	15
32 to 2 047	Reserved	2 016

**Byte 0 - Disk Category and Version Number**

Bits b<sub>0</sub> to b<sub>3</sub> shall specify the Version Number

They shall be set to 0001, indicating this ECMA Standard

Bits b<sub>4</sub> to b<sub>7</sub> shall specify the Disk Category

These bits shall be set to 0000, indicating a read-only disk.

Other settings are prohibited by this ECMA Standard ( see also annex L).

**Byte 1 - Disk size and maximum transfer rate**

Bits b<sub>0</sub> to b<sub>3</sub> shall specify the maximum transfer rate.

if set to 0000, they specify a maximum transfer rate of 2,52 Mbits/s

if set to 0001, they specify a maximum transfer rate of 5,04 Mbits/s

if set to 0010, they specify a maximum transfer rate of 10,08 Mbits/s

Bits  $b_4$  to  $b_7$  shall specify the disk size

They shall be set to 0000, indicating a 120 mm disk

Other settings are prohibited by this ECMA Standard (see also annex L).

#### **Byte 2 - Disk structure**

Bits  $b_0$  to  $b_3$  shall specify the type of the recorded layer(s)

They shall be set to 0001, indicating a read-only layer(s)

Bit  $b_4$  shall specify the track path

if set to ZERO, it specifies PTP on DL disks or a SL disk

if set to ONE, it specifies OTP on DL disks

Bits  $b_5$  and  $b_6$  shall specify the disk Type

if set to 00, they specify Type A or Type B

if set to 01, they specify Type C or Type D

Bit  $b_7$  shall be set to ZERO.

Other settings are prohibited by this ECMA Standard (see also annex L).

#### **Byte 3 - Recording density**

Bits  $b_0$  to  $b_3$  shall specify the average track pitch, they shall be set to 0000, indicating an average track pitch of 0,74  $\mu\text{m}$

Bits  $b_4$  to  $b_7$  shall specify the average Channel bit length

if set to 0000, they specify 0,133  $\mu\text{m}$

if set to 0001, they specify 0,147  $\mu\text{m}$

Other settings are prohibited by this ECMA Standard (see also annex L).

#### **Bytes 4 to 15 - Data Zone allocation**

Byte 4 shall be set to (00).

Bytes 5 to 7 shall be set to (030000) to specify the Sector Number 196 608 of the first Physical Sector of the Data Zone

Byte 8 shall be set to (00).

Bytes 9 to 11 shall specify the Sector Number of the last Physical Sector of the Data Zone

Byte 12 shall be set to (00)

Byte 13 to 15 shall be set to (00) on SL disks and DL disks in PTP mode, and to the Sector Number of the last Physical Sector of Layer 0 on DL disks in OTP mode.

#### **Byte 16 - BCA descriptor**

This byte shall specify whether or not there is a Burst Cutting Area on the disk.

bits  $b_0$  to  $b_6$  shall be set to ZERO

bit  $b_7$ , the BCA flag, shall specify whether or not a BCA exists

if set to ZERO, it shall indicate that a BCA does not exist

if set to ONE, it shall indicate that a BCA exists on a Type A or a Type C disk

On Type B and Type D disks, bit $_7$  shall be set to ZERO.

**Bytes 17 to 31**

These bytes shall be set to (00).

**Bytes 32 to 2 047**

These bytes shall be set to (00).

**26.5.2 Disk manufacturing information**

This ECMA Standard does not specify the format and the content of these 2 048 bytes. They shall be ignored in interchange.

**26.5.3 Content provider information**

The format and the content of these 28 672 bytes require agreement between the interchange parties, else these bytes shall be set to all ZEROs.

**27 Middle Zone**

The Main Data of the Data Frames eventually recorded as Physical Sectors in the Middle Zone shall have been set to (00). This ECMA Standard does not specify the number of Physical Sectors in the Middle Zone.

**28 Lead-out Zone**

The Main Data of the Data Frames eventually recorded as Physical Sectors in the Lead-out Zone shall have been set to (00). This ECMA Standard does not specify the number of Physical Sectors in the Lead-out Zone.





## Annex A

(normative)

### Measurement of the angular deviation $\alpha$

The angular deviation is the angle  $\alpha$  formed by an incident beam perpendicular to the Reference Plane P with the reflected beam (figure A.1.).

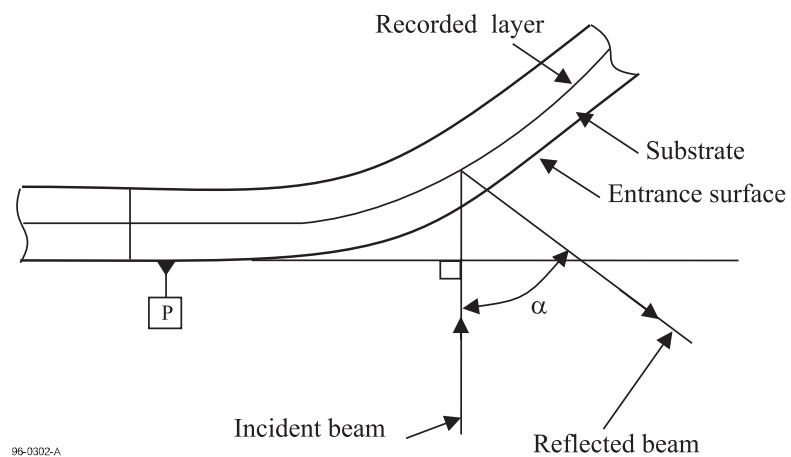

96-0302-A

Figure A.1 - Angular deviation  $\alpha$

For measuring the angular deviation  $\alpha$ , the disk shall be clamped between two concentric rings covering most of the Clamping Zone. The top clamping area shall have the same diameters as the bottom clamping area.

$$d_{\text{in}} = 22,3 \text{ mm} \begin{array}{l} + 0,5 \text{ mm} \\ - 0,0 \text{ mm} \end{array}$$

$$d_{\text{out}} = 32,7 \text{ mm} \begin{array}{l} + 0,0 \text{ mm} \\ - 0,5 \text{ mm} \end{array}$$

The total clamping force shall be  $F_1 = 2,0 \text{ N} \pm 0,5 \text{ N}$ . In order to prevent warping of the disk under the moment of force generated by the clamping force and the chucking force  $F_2$  exerted on the rim of the centre hole of the disk,  $F_2$  shall not exceed 0,5 N (figure A.2). This measurement shall be made under the conditions of 8.1.1.a).

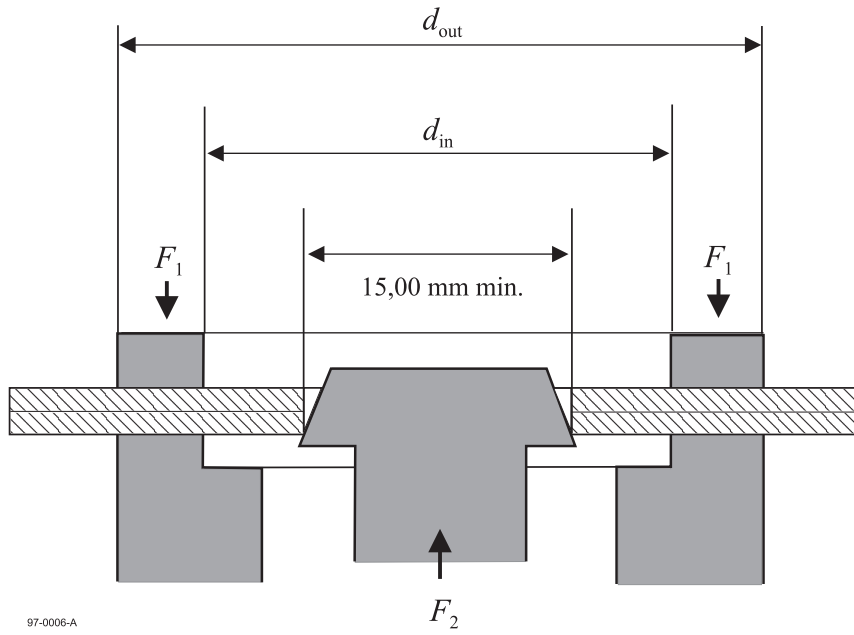

**Figure A.2 - Clamping and chucking conditions**

## Annex B

(normative)

### Measurement of birefringence

#### B.1 Principle of the measurement

In order to measure the birefringence, circularly polarized light in a parallel beam is used. The phase retardation is measured by observing the ellipticity of the reflected light.

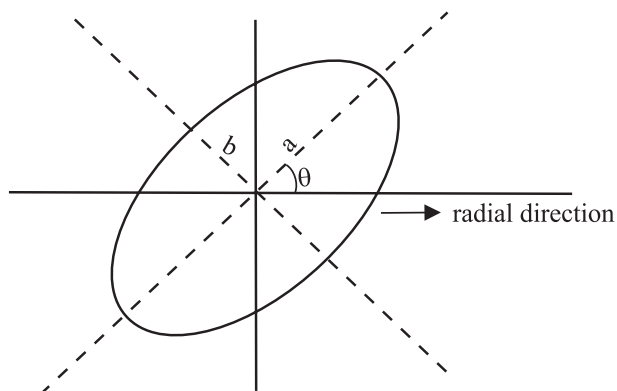

97-0008-A

**Figure B.1 - Ellipse with ellipticity  $e = b/a$  and orientation  $\theta$**

The orientation  $\theta$  of the ellipse is determined by the orientation of the optical axis

$$\theta = \gamma - \pi/4 \quad (\text{I})$$

where  $\gamma$  is the angle between the optical axis and the radial direction.

The ellipticity  $e = b/a$  is a function of the phase retardation  $\delta$

$$e = \tan \left[ \frac{1}{2} \left( \frac{\pi}{2} - \delta \right) \right] \quad (\text{II})$$

When the phase retardation  $\delta$  is known the birefringence  $BR$  can be expressed as a fraction of the wavelength

$$BR = \frac{\lambda}{2\pi} \delta \quad \text{nm} \quad (\text{III})$$

Thus, by observing the elliptically polarized light reflected from the disk, the birefringence can be measured and the orientation of the optical axis can be assessed as well.

#### B.2 Measurements conditions

The measurement of the birefringence specified above shall be made under the following conditions.

Mode of measurement in reflection, double pass through the substrate

Wavelength  $\lambda$  of the laser light 640 nm  $\pm$  15 nm

Beam diameter (FWHM) 1,0 mm  $\pm$  0,2 mm

Angle $\beta$ of incidence in radial direction relative to the radial plane perpendicular to Reference Plane P	$7,0^\circ \pm 0,2^\circ$
Clamping and chucking conditions	as specified by annex A
Disk mounting	horizontally
Rotation	less than 1 Hz
Temperature and relative humidity	as specified in 8.1.1)

### B.3 Example of a measuring set-up

Whilst this ECMA Standard does not prescribe a specific device for measuring birefringence, the device shown schematically in figure B.2 as an example, is well suited for this measurement.

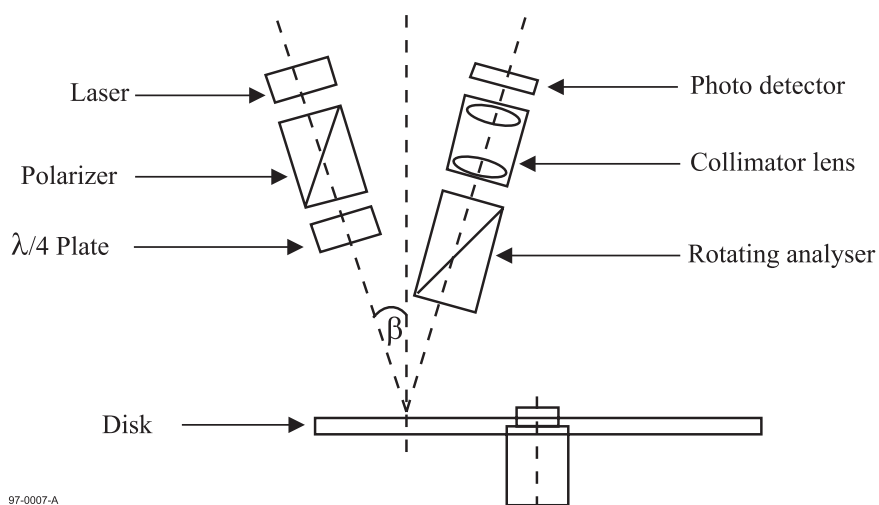

**Figure B.2 - Example of a device for the measurement of birefringence**

Light from a laser source, collimated into a polarizer (extinction ratio  $\approx 10^{-5}$ ), is made circular by a  $\lambda/4$  plate. The ellipticity of the reflected light is analyzed by a rotating analyzer and a photo detector. For every location on the disk, the minimum and the maximum values of the intensity are measured. The ellipticity can then be calculated as

$$e^2 = I_{\min} / I_{\max} \tag{IV}$$

Combining equations II, III and IV yields

$$BR = \lambda/4 - \lambda/\pi \times \arctan \sqrt{\frac{I_{\min}}{I_{\max}}}$$

This device can be easily calibrated as follows

- $I_{\min}$  is set to 0 by measuring a polarizer or a  $\lambda/4$  plate,
- $I_{\min} = I_{\max}$  when measuring a mirror

Apart of the d.c. contribution of the front surface reflection, a.c. components may occur, due to the interference of the reflection(s) of the front surface with the reflection(s) from the recorded layer. These a.c. reflectance effects are significant only if the disk substrate has an extremely accurate flatness and if the light source has a high coherence.

## Annex C

(normative)

### Measurement of the differential phase tracking error

#### C.1 Measuring method for the differential phase tracking error

The reference circuit for the measurement of the tracking error shall be that shown in figure C.1. Each output of the diagonal pairs of elements of the quadrant photo detector shall be digitized independently after equalization of the wave form defined by

$$H(s) = (1 + 1,6 \times 10^{-7} i\omega) / (1 + 4,7 \times 10^{-8} i\omega)$$

The gain of the comparators shall be sufficient to reach full saturation on the outputs, even with minimum signal amplitudes. Phases of the digitized pulse signal edges (signals B1 and B2) shall be compared to each other to produce a time-lead signal C1 and a time-lag signal C2. The phase comparator shall react to each individual edge with signal C1 or C2, depending on the sign of  $\Delta t_i$ . A tracking error signal shall be produced by smoothing the C1, C2 signals with low-pass filters and by subtracting by means of a unity gain differential amplifier. The low-pass filters shall be 1st order filters with a cut-off frequency of (-3 dB) 30 kHz.

Special attention shall be given to the implementation of the circuit because very small time differences have to be measured, indeed 1 % of T equals only 0,38 ns. Careful averaging is needed.

The average time difference between two signals from the diagonal pairs of elements of the quadrant detector shall be

$$\overline{\Delta t} = 1/N \sum \Delta t_i$$

where N is the number of edges both rising and falling.

#### C.2 Measurement of $\overline{\Delta t}/T$ without time interval analyzer

The relative time difference  $\overline{\Delta t}/T$  is represented by the amplitude of the tracking error signal provided that the amplitudes of the C1 and C2 signals and the frequency component of the read-out signals are normalized. The relation between the tracking error amplitude  $\overline{\Delta TVE}$  and the time difference is given by

$$\overline{\Delta TVE} = \frac{\sum \Delta t_i}{\sum T_i} V_{pc} = \frac{\sum \Delta t_i}{N n T} V_{pc} = \frac{\overline{\Delta t}}{T} \times \frac{V_{pc}}{n}$$

where

$V_{pc}$  is the amplitude of the C1 and C2 signals

$T_i$  is the actual length of the read-out signal in the range 3T to 14T

$nT$  is the weighted average value of the actual lengths

$N n T$  is the total averaging time

Assuming that  $V_{pc}$  equals  $\approx 5 V$  and that the measured value of  $n$  equals  $\approx 5$ , then the above relation between the tracking error amplitude  $\overline{\Delta TVE}$  and the time difference  $\overline{\Delta t}$  can be simplified to

$$\overline{\Delta TVE} = \overline{\Delta t} / T$$

The specification for the tracking gain can now be rewritten by using the tracking error amplitude as follows

$$0,5 (V_{pc}/n) \leq \overline{\Delta TVE} \leq 1,1 (V_{pc}/n)$$

at 0,1  $\mu\text{m}$  radial offset.

### C.3 Calibration of $\overline{\Delta t}/T$

As the gain of the phase comparator tends to vary, special attention shall be given to the calibration of the gain of the phase comparator. The following check and calibration method shall be applied for the measurement of the DPD tracking error signal.

a) Checking the measurement circuit

a.1) Measure the relation between the amplitude of the first comparator input ( $3T$ ) and the amplitude of the tracking error signal.

a.2) Check the current gain of the amplifier, using the saturation area (see figure C.2).

b) Determination of the calibration factor  $K$

b.1) Generate two sinusoidal signals  $A1$  and  $A2$  of frequency 2,616 MHz (corresponding to  $5T$ ) with phase difference, and feed them into two equalizer circuits.

b.2) Measure the relation between  $\overline{\Delta t}/T$  and  $\overline{\Delta TVE}/V_{pc}$ .

$$(\overline{\Delta TVE}/V_{pc}) K = (\overline{\Delta t}/T) / n$$

$$K = (0,2 \overline{\Delta t}/T) / (\overline{\Delta TVE}/V_{pc})$$

for  $n = 5$

The relation between  $\overline{\Delta t}/T$  and  $\overline{\Delta TVE}/V_{pc}$  is linear ( see figure C.3)

c) Compare the measured  $\overline{\Delta t}/T$  with the calculated one

c.1) Measure  $\overline{\Delta t}/T$  using the method of C.1.

c.2) Calculate  $\overline{\Delta t}/T(\text{real})$  as follows

$$\overline{\Delta t}/T(\text{real}) = K \times \overline{\Delta t}/T(\text{measured})$$

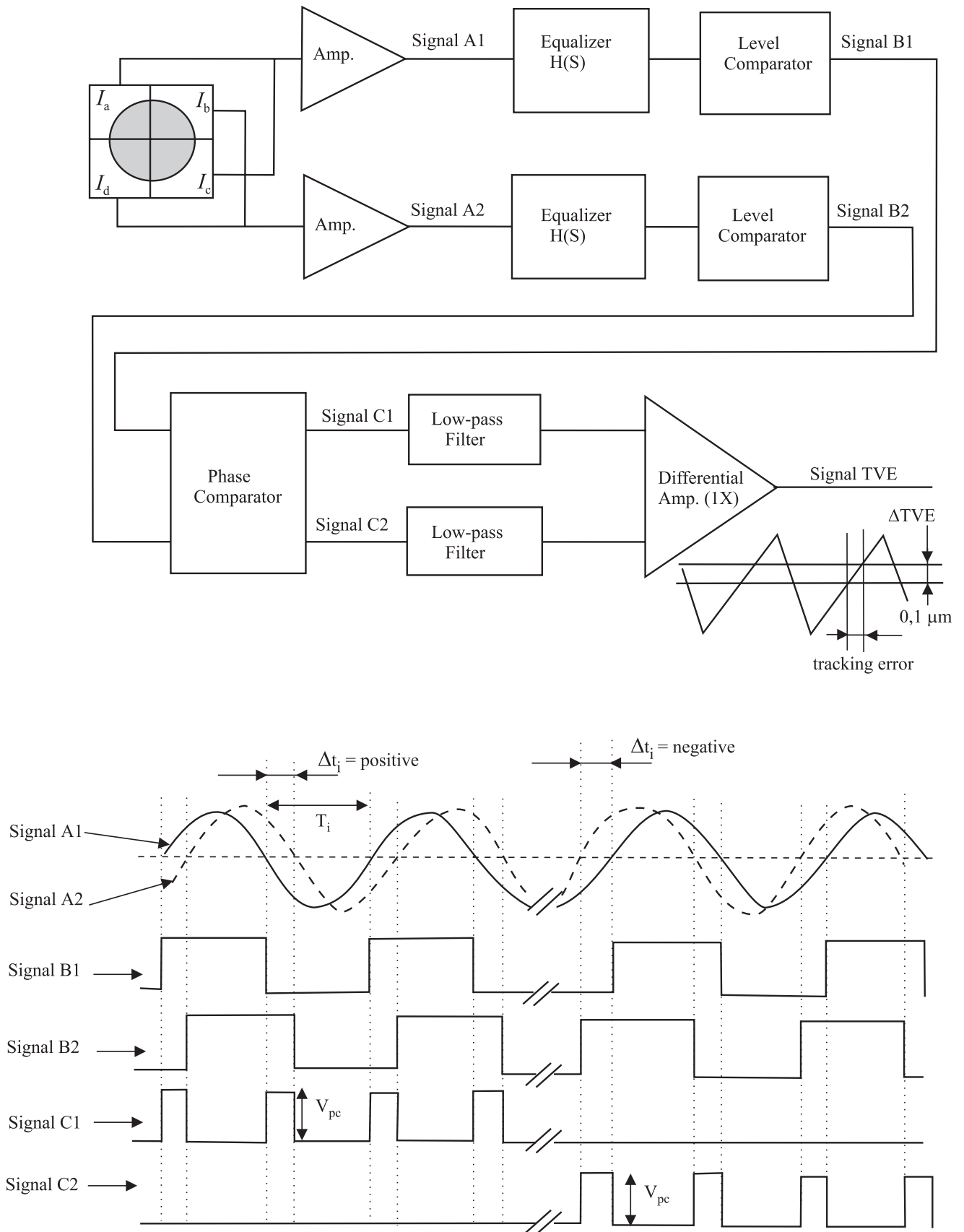

97-0010-A

Figure C.1 - Circuit for tracking error measurements

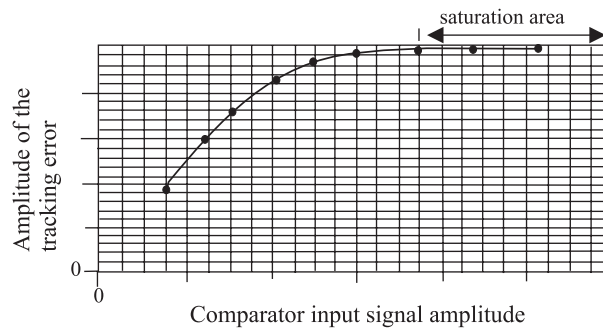

97-0011-A

Figure C.2 - Comparator input signal amplitude vs tracking error signal amplitude

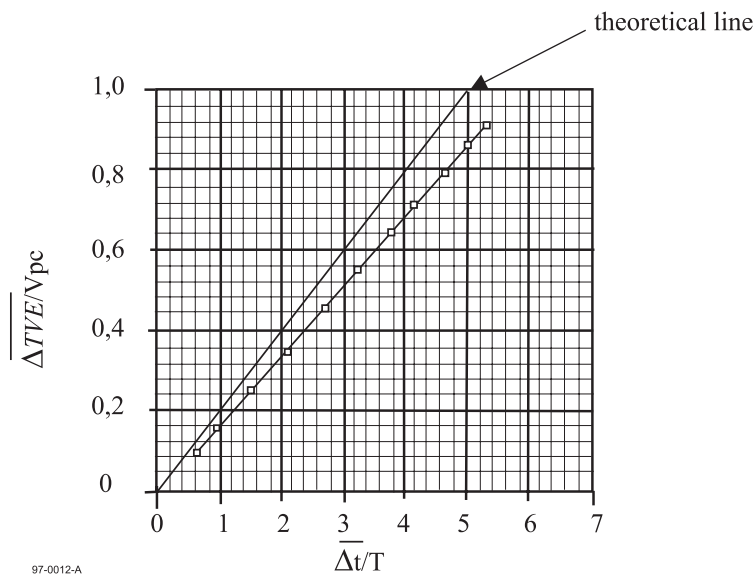

97-0012-A

Figure C.3 -  $\overline{\Delta t} / T$  vs  $\overline{\Delta TVE} / V_{pc}$



## Annex D

(normative)

### Measurement of light reflectance

#### D.1 Calibration method

A good reference disk shall be chosen, for instance 0,6 mm glass disk with a golden reflective mirror. This reference disk shall be measured by a parallel beam as shown in figure D.1

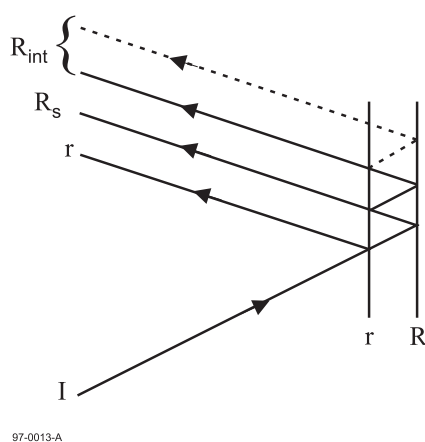

**Figure D.1 - Reflectance calibration**

In this figure the following applies.

I = incident beam

r = reflectance of the entrance surface

$R_s$  = main reflectance of the recorded layer

$R_{int}$  = other reflectances of the entrance surface and of the recorded layer

$R_{//}$  = measured value, using the arrangement of figure D.1

$$R_{//} = r + R_s + R_{int}$$

$$r = \left( \frac{n-1}{n+1} \right)^2 \text{ where } n \text{ is the refraction index of the substrate}$$

$$R_s = R_{//} - r - R_{int}$$

$$R_s = \left[ (1-r)^2 \times (R_{//} - r) \right] / \left[ 1-r \times (2 - R_{//}) \right]$$

The reference disk shall be measured on a reference drive and  $I_{mirror}$  measured by the focused beam is equated to  $R_s$  as determined above.

Now the arrangement is calibrated and the focused reflectivity is a linear function of the reflectivity of the recorded layer, independently from the reflectivity of the entrance surface.

## D.2 Measuring method

The measuring method comprises the following steps.

- a) Measure the reflective light power  $D_s$  from the reference disk with calibrated reflectivity  $R_s$
- b) Measure  $I_{14H}$  in the Information Zone of the disk (see 13.2).
- c) Calculate the reflectivity as follows

$$R_{14H} = R_s \times \frac{I_{14H}}{D_s}$$

## Annex E

(normative)

### Tapered cone for disk clamping

The device used for centring the disk for measurement shall be a cone with a taper angle  $\beta = 40,0^\circ \pm 0,5^\circ$  (see figure E.1).

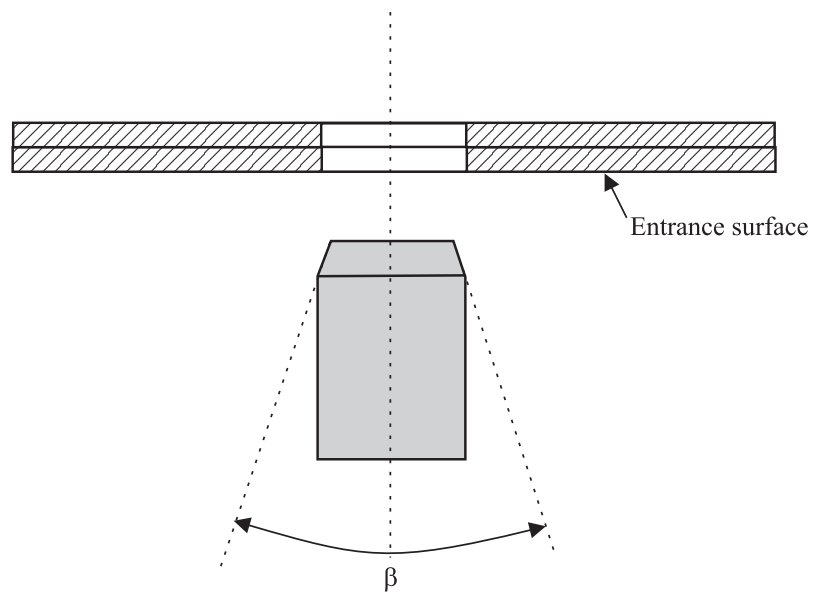

97-0014-A

**Figure E.1 - Tapered cone**



## Annex F

(normative)

### Measurement of jitter

Jitter shall be measured under the conditions of 9.1 with the additional conditions specified in this annex.

#### F.1 System diagram for jitter measurement

The general system diagram for jitter measurement shall be as shown in figure F.1.

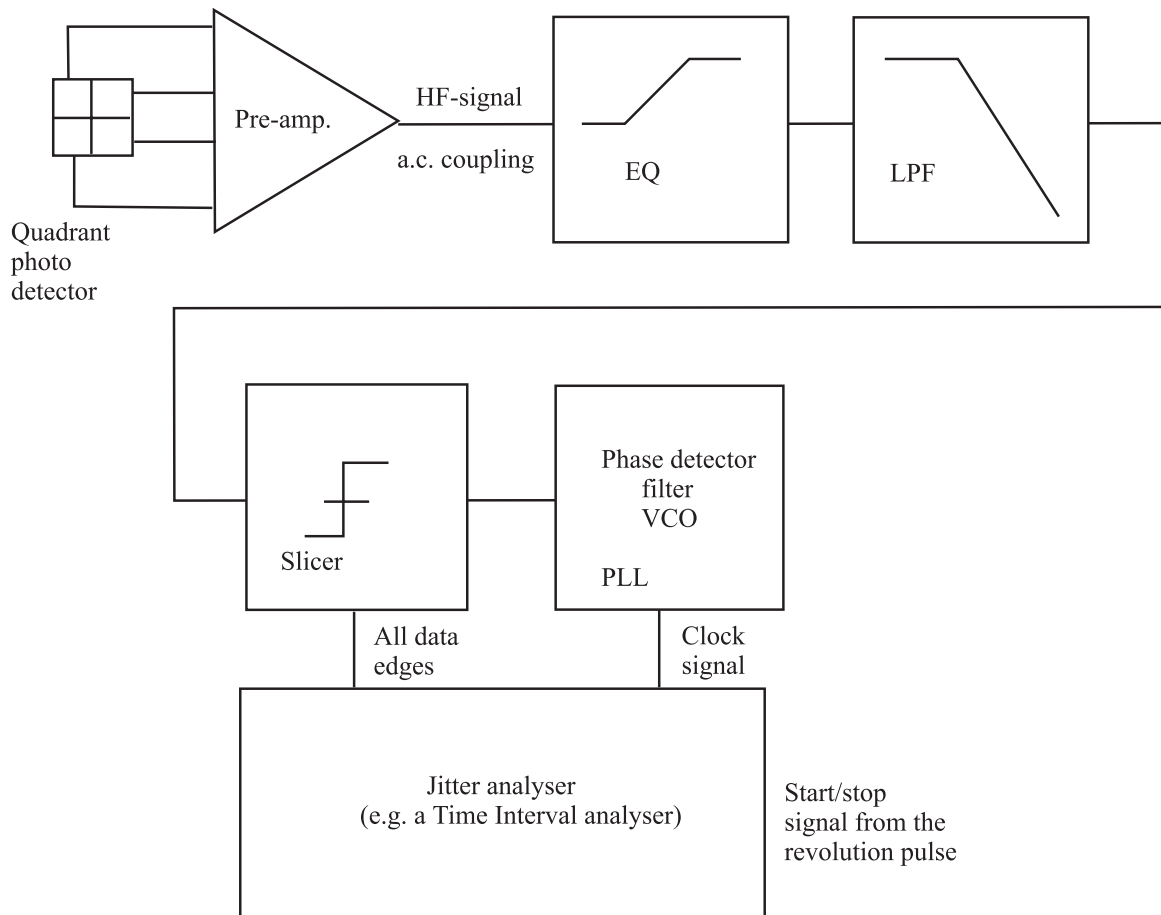

97-0015-A

Figure F.1 - General diagram for jitter measurement

## F.2 Open loop transfer function for PLL

The open-loop transfer function for the PLL shown in figure F.1 shall be as shown in figure F.2

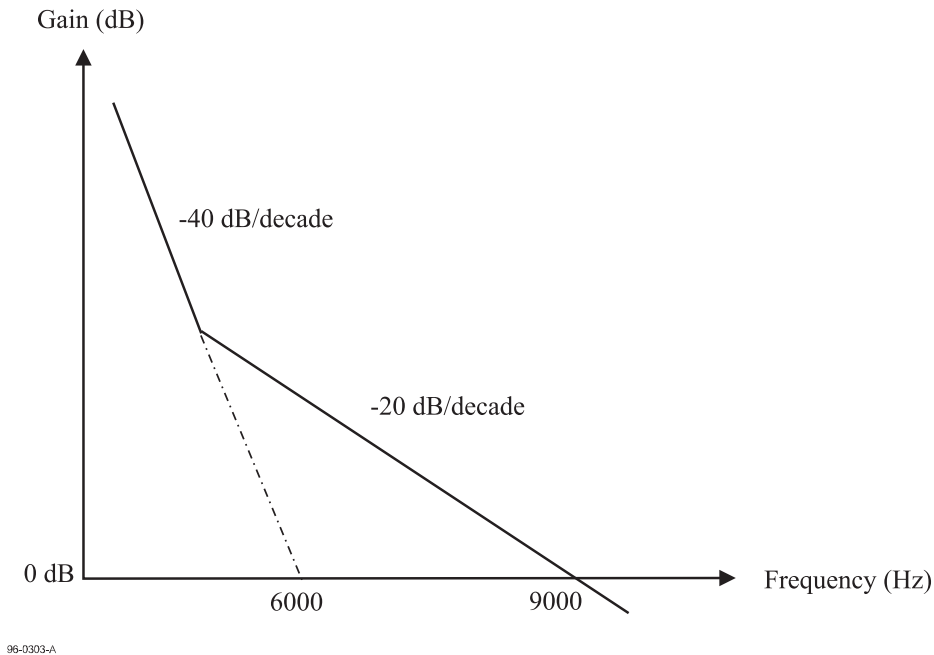

Figure F.2 - Schematic representation of the open-loop transfer function for PLL

## F.3 Slicer

The slicer shall be a feed-back auto-slicer with a -3 dB closed-loop bandwidth of 5 kHz, 1<sup>st</sup> order integrating

## F.4 Conditions for measurement

The bandwidth of the pre-amplifier of the photo detector shall be greater than 20 MHz in order to prevent group-delay distortion.

Low-pass filter : 6th order Bessel filter,  $f_c$  (-3 dB) = 8,2 MHz

Example of an analogue equalizer : 3-tap transversal filter with transfer function

$$H(z) = 1,35 z^{-2,093} - 0,175 (1 + z^{-4,186})$$

Filtering and equalization :

- Gain variation : 1 dB max. (below 7 MHz)
- Group delay variation : 3 ns max. (below 6,5 MHz)
- (Gain at 5,0 MHz - Gain at 0 Hz) = 3,2 dB  $\pm$  0,3 dB

a.c. coupling (high-pass filter) = 1st order,  $f_c$  (-3 dB) = 1 kHz

Correction of the angular deviation : only d.c. deviation.

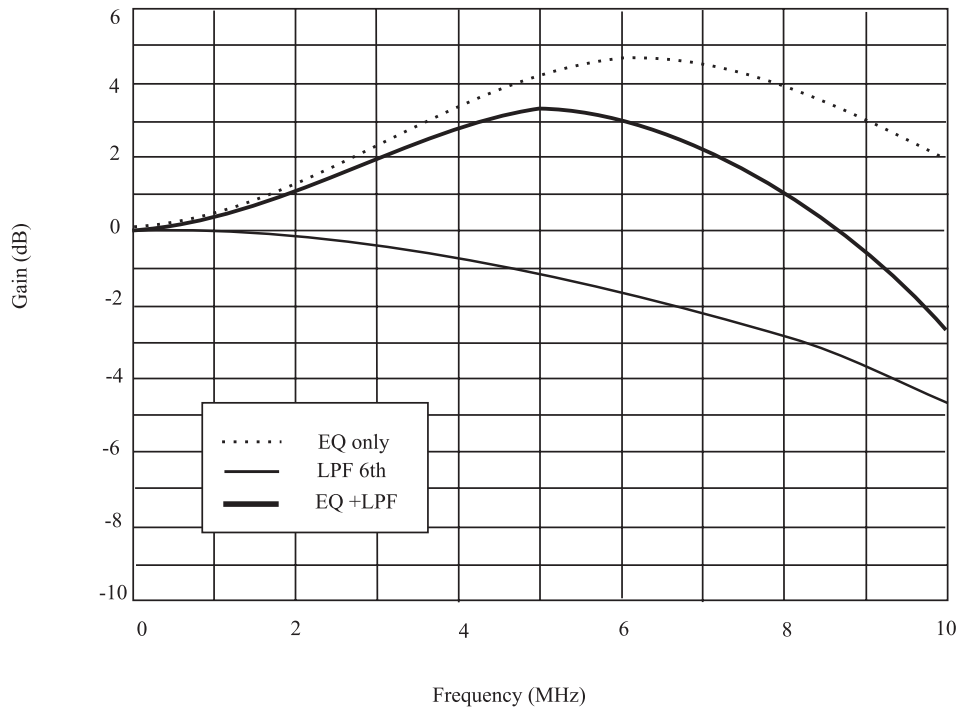

96-0304-A

**Figure F.3 - Frequency characteristics for the equalizer and the low-pass filter**

## F.5 Measurement

The jitter of all leading and trailing edges over one rotation shall be measured.

Under this measurement, the jitter shall be less than 8,0 % of the Channel bit clock period.





## Annex G

(normative)

### 8-to-16 Modulation with RLL (2,10) requirements

Tables G.1 and G.2 list the 16-bit Code Words into which the 8-bit coded Data bytes have to be transformed. Figure G.1 shows schematically how the Code Words and the associated State specification are generated.

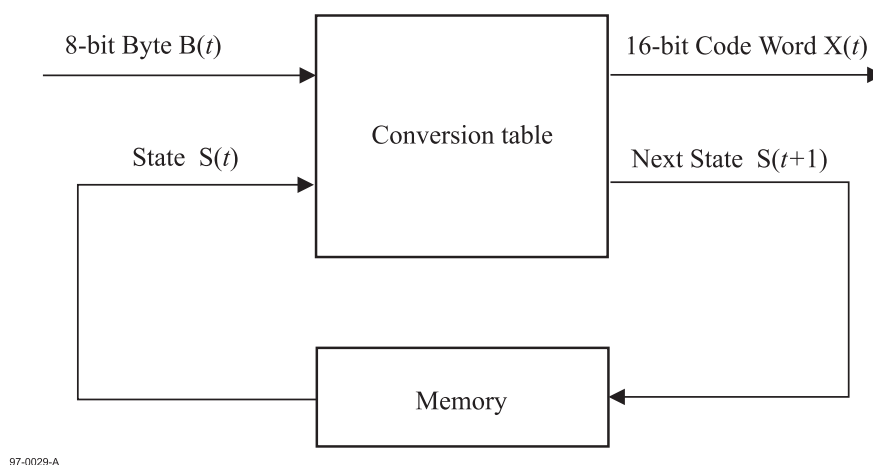

**Figure G.1 - Code Words generation**

In this figure :

$$X(t) = H \{B(t), S(t)\}$$

$$X_{15}(t) = \text{msb and } X_0(t) = \text{lsb}$$

$$S(t+1) = G\{B(t), S(t)\}$$

H is the output function

G is the next-state function

The Code Words leaving the States shall be chosen so that the concatenation of Code Words entering a State and those leaving that State satisfy the requirement that between two ONES there shall be at least 2 and at most 10 ZEROS.

As additional requirements:

- Code Words leaving State 2 shall have both bit  $x_{15}$  and bit  $x_3$  set to ZERO, and
- in Code Words leaving State 3 bit  $x_{15}$  or bit  $x_3$  or both shall be set to ONE.

This means that the Code Word sets of States 2 and 3 are disjoint.

Code Word $X(t)$	Next State $S(t+1)$	Code Word $X(t+1)$
Ends with 1 or no trailing ZERO	State 1	Starts with 2 or up to 9 leading ZEROS
Ends with 2 or up to 5 trailing ZEROS	State 2	Starts with 1 or up to 5 leading ZEROS, and $X_{15}(t+1), X_3(t+1) = 0,0$
Ends with 2 or up to 5 trailing ZEROS	State 3	Starts with none or up to 5 leading ZEROS, and $X_{15}(t+1), X_3(t+1) \neq 0,0$
Ends with 6 or up to 9 trailing ZEROS	State 4	Starts with 1 or no leading ZERO

**Figure G.2 - Determination of States**

Note that when decoding the recorded data, knowledge about the encoder is required to be able to reconstitute the original main Data.

$$B(t) = H^{-1} \{X(t), S(t)\}$$

Because of the involved error propagation, such state-dependent decoding is to be avoided. In the case of this 8-to-16 modulation, the conversion tables have been chosen in such a way that knowledge about the State is not required in most cases. As can be gathered from the tables, in some cases, two 8-bit bytes, for instance the 8-bit bytes 5 and 6 in States 1 and 2 in table G.1, generate the same 16-bit Code Words. The construction of the tables allows to solve this apparent ambiguity. Indeed, if two identical Code Words leave a State, one of them goes to State 2 and the other to State 3. Because the setting of bits  $X_{15}$  and  $X_3$  is always different in these two States, any Code Word can be uniquely decoded by analysing the Code Word itself together with bits  $X_{15}$  and  $X_3$  of the next Code Word :

$$B(t) = H^{-1} \{ X(t), X_{15}(t+1), X_3(t+1) \}$$

In the tables, the 8-bit bytes are identified by their decimal value.

**Table G.1 - Main Conversion Table**

8-bit byte	State 1			State 2			State 3			State 4		
	Code Word		Next	Code Word		Next	Code Word		Next	Code Word		Next
	msb	lsb	State	msb	lsb	State	msb	lsb	State	msb	lsb	State
0	001000000001001	1	0100000100100000	2	001000000001001	1	0100000100100000	2				
1	0010000000010010	1	0010000000010010	1	1000000100100000	3	1000000100100000	3				
2	0010000100100000	2	0010000100100000	2	1000000000010010	1	1000000000010010	1				
3	0010000001001000	2	0100010010000000	4	0010000001001000	2	0100010010000000	4				
4	0010000010010000	2	0010000010010000	2	1000000100100000	2	1000000100100000	2				
5	0010000000100100	2	0010000000100100	2	1001001000000000	4	1001001000000000	4				
6	0010000000100100	3	0010000000100100	3	1000100100000000	4	1000100100000000	4				
7	0010000001001000	3	0100000000010010	1	0010000001001000	3	0100000000010010	1				
8	0010000010010000	3	0010000010010000	3	1000010010000000	4	1000010010000000	4				
9	0010000100100000	3	0010000100100000	3	1001001000000001	1	1001001000000001	1				
10	0010010010000000	4	0010010010000000	4	1000100100000001	1	1000100100000001	1				
11	0010001001000000	4	0010001001000000	4	1000000010010000	3	1000000010010000	3				
12	0010010010000001	1	0010010010000001	1	1000000010010000	2	1000000010010000	2				
13	0010001001000001	1	0010001001000001	1	1000010010000001	1	1000010010000001	1				
14	0010000001001001	1	0100000000100100	3	0010000001001001	1	0100000000100100	3				
15	0010000100100001	1	0010000100100001	1	1000001001000001	1	1000001001000001	1				
16	0010000010010001	1	0010000010010001	1	1000000100100001	1	1000000100100001	1				
17	0010000000100010	1	0010000000100010	1	1000001001000000	4	1000001001000000	4				
18	0001000000001001	1	0100000010010000	2	0001000000001001	1	0100000010010000	2				
19	0010000000010001	1	0010000000010001	1	1001000100000000	4	1001000100000000	4				
20	0001000000010010	1	0001000000010010	1	1000100010000000	4	1000100010000000	4				
21	0000100000000010	1	0000100000000010	1	1000000010010001	1	1000000010010001	1				
22	0000010000000001	1	0000010000000001	1	1000000001001001	1	1000000001001001	1				
23	0010001000100000	2	0010001000100000	2	1000000001001000	2	1000000001001000	2				
24	0010000100010000	2	0010000100010000	2	1000000001001000	3	1000000001001000	3				
25	0010000010001000	2	0100000000100100	2	0010000010001000	2	0100000000100100	2				
26	0010000001000100	2	0010000001000100	2	1000000000100010	1	1000000000100010	1				
27	0001000010010000	2	0001000010010000	2	1000000000010001	1	1000000000010001	1				
28	0010000000010000	2	0100000010010000	3	0010000000010000	2	0100000010010000	3				
29	0001000010010000	2	0001000010010000	2	1001001000000010	1	1001001000000010	1				
30	0001000001001000	2	0100000100100000	3	0001000001001000	2	0100000100100000	3				
31	0001000000100100	2	0001000000100100	2	1001000100000001	1	1001000100000001	1				
32	0001000000000100	2	0001000000000100	2	1000100100000010	1	1000100100000010	1				
33	0001000000000100	3	0001000000000100	3	1000100010000001	1	1000100010000001	1				
34	0001000000100100	3	0001000000100100	3	1000000000100100	2	1000000000100100	2				
35	0001000001001000	3	0100001001000000	4	0001000001001000	3	0100001001000000	4				
36	0001000010010000	3	0001000010010000	3	1000000000100100	3	1000000000100100	3				
37	0001000100100000	3	0001000100100000	3	1000010001000000	4	1000010001000000	4				
38	0010000000001000	3	0100100100000001	1	0010000000001000	3	0100100100000001	1				
39	0010000001000100	3	0010000001000100	3	1001000010000000	4	1001000010000000	4				
40	0010000010001000	3	0100010010000001	1	0010000010001000	3	0100010010000001	1				
41	0010000100010000	3	0010000100010000	3	1000010010000010	1	1000010010000010	1				
42	0010001000100000	3	0010001000100000	3	1000001000100000	2	1000001000100000	2				
43	0010010001000000	4	0010010001000000	4	1000010001000001	1	1000010001000001	1				
44	0001001001000000	4	0001001001000000	4	1000001000100000	3	1000001000100000	3				
45	0000001000000001	1	0100010001000000	4	1000001001000010	1	0100010001000000	4				

continued

**Table G.1 - Main Conversion Table (continued)**

8-bit byte	State 1			State 2			State 3			State 4		
	Code Word		Next	Code Word		Next	Code Word		Next	Code Word		Next
	msb	lsb	State	msb	lsb	State	msb	lsb	State	msb	lsb	State
46	0010010010000010	1	0010010010000010	1	1000001000100001	1	1000001000100001	1	1000001000100001	1		
47	0010000010001001	1	0100001001000001	1	0010000010001001	1	0100001001000001	1	0100001001000001	1		
48	0010010001000001	1	0010010001000001	1	1000000100010000	2	1000000100010000	2	1000000100010000	2		
49	0010001001000010	1	0010001001000010	1	1000000010001000	2	1000000010001000	2	1000000010001000	2		
50	0010001000100001	1	0010001000100001	1	1000000100010000	3	1000000100010000	3	1000000100010000	3		
51	0001000001001001	1	0100000100100001	1	0001000001001001	1	0100000100100001	1	0100000100100001	1		
52	0010000100100010	1	0010000100100010	1	1000000100100010	1	1000000100100010	1	1000000100100010	1		
53	0010000100010001	1	0010000100010001	1	1000000100010001	1	1000000100010001	1	1000000100010001	1		
54	0010000010010010	1	0010000010010010	1	1000000010010010	1	1000000010010010	1	1000000010010010	1		
55	0010000001000010	1	0010000001000010	1	1000000001000010	1	1000000001000010	1	1000000001000010	1		
56	0010000000100001	1	0010000000100001	1	1000000000100001	1	1000000000100001	1	1000000000100001	1		
57	0000100000001001	1	0100000010010001	1	0000100000001001	1	0100000000100001	1	0100000000100001	1		
58	0001001001000001	1	0001001001000001	1	1000000000100001	1	1000000000100001	1	1000000000100001	1		
59	0001000100100001	1	0001000100100001	1	0100000001001001	1	0100000001001001	1	0100000001001001	1		
60	0001000010010001	1	0001000010010001	1	1001001000010010	1	1001001000010010	1	1001001000010010	1		
61	0001000000100010	1	0001000000100010	1	1001001000001001	1	1001001000001001	1	1001001000001001	1		
62	0001000000010001	1	0001000000010001	1	1001000100000010	1	1001000100000010	1	1001000100000010	1		
63	00001000000010010	1	00001000000010010	1	1000000001000100	2	1000000001000100	2	1000000001000100	2		
64	0000010000000010	1	0000010000000010	1	0100000001001000	2	0100000001001000	2	0100000001001000	2		
65	0010010000100000	2	0010010000100000	2	1000010000100000	2	1000010000100000	2	1000010000100000	2		
66	0010001000010000	2	0010001000010000	2	1000001000010000	2	1000001000010000	2	1000001000010000	2		
67	0010000100001000	2	0100000000100010	1	0010000100001000	2	0100000000100010	1	0100000000100010	1		
68	0010000010000100	2	0010000010000100	2	1000000100001000	2	1000000100001000	2	1000000100001000	2		
69	0010000000010000	2	0010000000010000	2	1000000010000100	2	1000000010000100	2	1000000010000100	2		
70	0001000010001000	2	0100001000100000	2	0001000010001000	2	0100001000100000	2	0100001000100000	2		
71	0001001000100000	2	0001001000100000	2	0100000010001000	2	0100000010001000	2	0100000010001000	2		
72	0001000000001000	2	0100000100010000	2	0001000000001000	2	0100000100010000	2	0100000100010000	2		
73	0001000100010000	2	0001000100010000	2	1000000001000100	3	1000000001000100	3	1000000001000100	3		
74	0001000001000100	2	0001000001000100	2	0100000001001000	3	0100000001001000	3	0100000001001000	3		
75	0000100100100000	2	0000100100100000	2	1000010000100000	3	1000010000100000	3	1000010000100000	3		
76	0000100010010000	2	0000100010010000	2	1000001000010000	3	1000001000010000	3	1000001000010000	3		
77	0000100001001000	2	0100000001000100	2	0000100001001000	2	0100000001000100	2	0100000001000100	2		
78	0000100000100100	2	0000100000100100	2	1000000100001000	3	1000000100001000	3	1000000100001000	3		
79	0000100000000100	2	0000100000000100	2	1000000010000100	3	1000000010000100	3	1000000010000100	3		
80	0000100000000100	3	0000100000000100	3	0100000010001000	3	0100000010001000	3	0100000010001000	3		
81	0000100000100100	3	0000100000100100	3	1000100001000000	4	1000100001000000	4	1000100001000000	4		
82	0000100001001000	3	0100000001000100	3	0000100001001000	3	0100000001000100	3	0100000001000100	3		
83	0000100010010000	3	0000100010010000	3	1000000010001000	3	1000000010001000	3	1000000010001000	3		
84	0000100100100000	3	0000100100100000	3	1001001001001000	2	1001001001001000	2	1001001001001000	2		
85	0001000000001000	3	0100000100010000	3	0001000000001000	3	0100000100010000	3	0100000100010000	3		
86	0001000001000100	3	0001000001000100	3	1001001000100100	2	1001001000100100	2	1001001000100100	2		
87	0001000010001000	3	0100001000100000	3	0001000010001000	3	0100001000100000	3	0100001000100000	3		
88	0001000100010000	3	0001000100010000	3	1001001001001000	3	1001001001001000	3	1001001001001000	3		
89	0001001000100000	3	0001001000100000	3	1001000010000001	1	1001000010000001	1	1001000010000001	1		
90	0010000000010000	3	0010000000010000	3	1000100100010010	1	1000100100010010	1	1000100100010010	1		
91	0010000010000100	3	0010000010000100	3	1000100100001001	1	1000100100001001	1	1000100100001001	1		
92	0010000100001000	3	0100000000010001	1	0010000100001000	3	0100000000010001	1	0100000000010001	1		
93	0010001000010000	3	0010001000010000	3	1000100010000010	1	1000100010000010	1	1000100010000010	1		
94	0010010000100000	3	0010010000100000	3	1000100001000001	1	1000100001000001	1	1000100001000001	1		

**Table G.1 - Main Conversion Table (continued)**

8-bit byte	State 1			State 2			State 3			State 4		
	Code Word		Next	Code Word		Next	Code Word		Next	Code Word		Next
	msb	lsb	State	msb	lsb	State	msb	lsb	State	msb	lsb	State
95	0000001000000010	1	0100100100000010	1	1000010010010010	1	0100100100000010	1				
96	0000000100000001	1	0100100010000001	1	1000010010001001	1	0100100010000001	1				
97	0010010010001001	1	0100010000100000	2	0010010010001001	1	0100010000100000	2				
98	0010010010010010	1	0010010010010010	1	1001001000000100	2	1001001000000100	2				
99	0010010001000010	1	0010010001000010	1	1001001000100100	3	1001001000100100	3				
100	0010010000100001	1	0010010000100001	1	1000010001000010	1	1000010001000010	1				
101	0010001001001001	1	0100010010000010	1	0010001001001001	1	0100010010000010	1				
102	0010001000100010	1	0010001000100010	1	1000010000100001	1	1000010000100001	1				
103	0010001000010001	1	0010001000010001	1	1000001001001001	1	1000001001001001	1				
104	0010000100010010	1	0010000100010010	1	1000001000100010	1	1000001000100010	1				
105	0010000010000010	1	0010000010000010	1	1000001000010001	1	1000001000010001	1				
106	0010000100001001	1	0100001000010000	2	0010000100001001	1	0100001000010000	2				
107	0010000001000001	1	0010000001000001	1	1000000100010010	1	1000000100010010	1				
108	0001001001000010	1	0001001001000010	1	1000000100001001	1	1000000100001001	1				
109	0001001000100001	1	0001001000100001	1	1000000010000010	1	1000000010000010	1				
110	0001000100100010	1	0001000100100010	1	1000000001000001	1	1000000001000001	1				
111	00010000100010001	1	00010000100010001	1	0100000010001001	1	0100000010001001	1				
112	0001000010010010	1	0001000010010010	1	1001001001001001	1	1001001001001001	1				
113	0001000001000010	1	0001000001000010	1	1001001000100010	1	1001001000100010	1				
114	0001000010001001	1	0100010000100000	3	0001000010001001	1	0100010000100000	3				
115	0001000000100001	1	0001000000100001	1	1001001000010001	1	1001001000010001	1				
116	0000100100100001	1	0000100100100001	1	1001000100010010	1	1001000100010010	1				
117	0000100010010001	1	0000100010010001	1	1001000100001001	1	1001000100001001	1				
118	0000100001001001	1	0100010001000001	1	0000100001001001	1	0100010001000001	1				
119	0000100000100010	1	0000100000100010	1	1000100100100100	2	1000100100100100	2				
120	0000100000010001	1	0000100000010001	1	1000100100000100	2	1000100100000100	2				
121	0000010000001001	1	0100001001000010	1	0000010000001001	1	0100001001000010	1				
122	0000010000010010	1	0000010000010010	1	1000100000100000	2	1000100000100000	2				
123	0010010010000100	2	0010010010000100	2	1000010010000100	2	1000010010000100	2				
124	0010010000010000	2	0010010000010000	2	1000010000010000	2	1000010000010000	2				
125	0010001000001000	2	0100001000100001	1	0010001000001000	2	0100001000100001	1				
126	0010001001000100	2	0010001001000100	2	1000001001000100	2	1000001001000100	2				
127	0001000100001000	2	0100000100100010	1	0001000100001000	2	0100000100100010	1				
128	0010000100100100	2	0010000100100100	2	1000001000001000	2	1000001000001000	2				
129	0000100010001000	2	0100000100010001	1	0000100010001000	2	0100000100010001	1				
130	0010000100000100	2	0010000100000100	2	1000000100100100	2	1000000100100100	2				
131	0010000000100000	2	0010000000100000	2	1001001000000100	3	1001001000000100	3				
132	0001001000010000	2	0001001000010000	2	1000100100100100	3	1000100100100100	3				
133	0000100000001000	2	0100000010010010	1	0000100000001000	2	0100000010010010	1				
134	0001000010000100	2	0001000010000100	2	1000100000100000	3	1000100000100000	3				
135	0001000000001000	2	0001000000001000	2	1000010010000100	3	1000010010000100	3				
136	0000100100010000	2	0000100100010000	2	1000010000010000	3	1000010000010000	3				
137	0000100001000100	2	0000100001000100	2	1000001001000100	3	1000001001000100	3				
138	0000010001001000	2	0100000001000010	1	0000010001001000	2	0100000001000010	1				
139	0000010010010000	2	0000010010010000	2	1000001000001000	3	1000001000001000	3				
140	0000010000100100	2	0000010000100100	2	1001000010000010	1	1001000010000010	1				
141	0000010000000100	2	0000010000000100	2	1000000100000100	2	1000000100000100	2				
142	0000010000000100	3	0000010000000100	3	1000000100100100	3	1000000100100100	3				
143	0000010000100100	3	0000010000100100	3	1000000100000100	3	1000000100000100	3				

**Table G.1 - Main Conversion Table (continued)**

8-bit byte	State 1			State 2			State 3			State 4		
	Code Word		Next	Code Word		Next	Code Word		Next	Code Word		Next
	msb	lsb	State	msb	lsb	State	msb	lsb	State	msb	lsb	State
144	0000010001001000	3	0100000010000100	2	0000010001001000	3	0100000010000100	2	0000010001001000	3	0100000010000100	2
145	0000010010010000	3	0000010010010000	3	1001000001000000	4	1001000001000000	4	1001000001000000	4	1001000001000000	4
146	0000100000001000	3	0100000000100000	2	0000100000001000	3	0100000000100000	3	0100000000100000	3	0100000000100000	2
147	0000100001000100	3	0000100001000100	3	1000000000100000	2	1000000000100000	2	1000000000100000	2	1000000000100000	2
148	0000100010001000	3	0100000010001000	3	0000100010001000	3	0000100010001000	3	0100000010001000	3	0100000010001000	3
149	0000100100010000	3	0000100100010000	3	1000000000100000	3	1000000000100000	3	1000000000100000	3	1000000000100000	3
150	0001000000010000	3	0001000000010000	3	0100000100001000	3	0100000100001000	3	0100000100001000	3	0100000100001000	3
151	0001000010000100	3	0001000010000100	3	1000000001000000	4	1000000001000000	4	1000000001000000	4	1000000001000000	4
152	0001000100001000	3	0100001000010000	3	0001000100001000	3	0001000100001000	3	0100001000010000	3	0100001000010000	3
153	0001001000010000	3	0001001000010000	3	1001000001000001	1	1001000001000001	1	1001000001000001	1	1001000001000001	1
154	0010000000100000	3	0010000000100000	3	0100000100001000	2	0100000100001000	2	0100000100001000	2	0100000100001000	2
155	0010000100000100	3	0010000100000100	3	1001000100100100	3	1001000100100100	3	1001000100100100	3	1001000100100100	3
156	0010000100100100	3	0010000100100100	3	1000100100100010	1	1000100100100010	1	1000100100100010	1	1000100100100010	1
157	0010001000001000	3	0100000000100001	1	0010001000001000	3	0100000000100001	3	0100000000100001	3	0100000000100001	1
158	0010001001000100	3	0010001001000100	3	1000100100000100	3	1000100100000100	3	0100100100000000	4	0100100100000000	4
159	0010010000010000	3	0010010000010000	3	1001001001000100	2	1001001001000100	2	1001001001000100	2	1001001001000100	2
160	0010010010000100	3	0010010010000100	3	1001001000001000	2	1001001000001000	2	1001001000001000	2	1001001000001000	2
161	0000001000010010	1	0100000000100000	3	1000100100010001	1	0100000000100000	3	0100000000100000	3	0100000000100000	3
162	0000001000001001	1	0100100100100100	2	1000100010010010	1	0100100100100100	2	0100100100100100	2	0100100100100100	2
163	0000000100000010	1	0100100100100100	3	1000100010001001	1	0100100100100100	3	0100100100100100	3	0100100100100100	3
164	0000000010000001	1	0100100100010010	1	1000100001000010	1	0100100100010010	1	0100100100010010	1	0100100100010010	1
165	0010010010010001	1	0010010010010001	1	1001000100100100	2	0010010010010001	2	0010010010010001	2	0010010010010001	2
166	0010010000100010	1	0010010000100010	1	1001000100000100	2	0010010000100010	2	0010010000100010	2	0010010000100010	2
167	0010010001001001	1	0100100100000100	2	0010010001001001	1	0100100100000100	2	0010010001001001	1	0100100100000100	2
168	0010010000010001	1	0010010000010001	1	1001001001000100	3	0010010000010001	3	0010010000010001	3	0010010000010001	3
169	0010001000010010	1	0010001000010010	1	1000100000100001	1	0010001000010010	1	1000100000100001	1	0010001000010010	1
170	0010000100000010	1	0010000100000010	1	1000010010010001	1	0010000100000010	1	1000010010010001	1	0010000100000010	1
171	0010001000001001	1	0100100000100000	3	0010001000001001	1	0100100000100000	3	0010001000001001	1	0100100000100000	3
172	0010000010000001	1	0010000010000001	1	1000010001001001	1	0010000010000001	1	1000010001001001	1	0010000010000001	1
173	0001001000100010	1	0001001000100010	1	1000010000100010	1	0001001000100010	1	1000010000100010	1	0001001000100010	1
174	0001001000010001	1	0001001000010001	1	1000010000010001	1	0001001000010001	1	1000010000010001	1	0001001000010001	1
175	0001000100010010	1	0001000100010010	1	1000001000010010	1	0001000100010010	1	1000001000010010	1	0001000100010010	1
176	0001000010000010	1	0001000010000010	1	1000001000001001	1	0001000010000010	1	1000001000001001	1	0001000010000010	1
177	0001001001001001	1	0100100010000010	1	0001001001001001	1	0100100010000010	1	0001001001001001	1	0100100010000010	1
178	0001000001000001	1	0001000001000001	1	1000000100000010	1	0001000001000001	1	1000000100000010	1	0001000001000001	1
179	0000100100100010	1	0000100100100010	1	1000000010000001	1	0000100100100010	1	1000000010000001	1	0000100100100010	1
180	0000100100010001	1	0000100100010001	1	0100100100001001	1	0000100100010001	1	0100100100001001	1	0000100100010001	1
181	0001000100001001	1	0100100000100000	2	0001000100001001	1	0100100000100000	2	0001000100001001	1	0100100000100000	2
182	0000100010010010	1	0000100010010010	1	0100010010001001	1	0000100010010010	1	0100010010001001	1	0000100010010010	1
183	0000100001000010	1	0000100001000010	1	0100001001001001	1	0000100001000010	1	0100001001001001	1	0000100001000010	1
184	0000100010001001	1	0100010010000100	3	0000100010001001	1	0100010010000100	3	0000100010001001	1	0100010010000100	3
185	0000100000100001	1	0000100000100001	1	1001000000100000	2	0000100000100001	2	1001000000100000	2	0000100000100001	2
186	0000010010010001	1	0000010010010001	1	1000100100001000	2	0000010010010001	2	1000100100001000	2	0000010010010001	2
187	0000010000100010	1	0000010000100010	1	1000100010000100	2	0000010000100010	2	1000100010000100	2	0000010000100010	2
188	0000010001001001	1	0100100001000001	1	0000010001001001	1	0100100001000001	1	0000010001001001	1	0100100001000001	1
189	0000010000010001	1	0000010000010001	1	1000100000010000	2	0000010000010001	2	1000100000010000	2	0000010000010001	2
190	0000001001001000	2	0100010010000100	2	1000010010001000	2	0000001001001000	2	0100010010000100	2	1000010010001000	2
191	0000001000100100	2	0100010000010000	2	1000010001000100	2	0000001000100100	2	0100010000010000	2	1000010001000100	2
192	0000001000000100	2	0100001001000100	2	1000010000001000	2	0000001000000100	2	0100001001000100	2	1000010000001000	2

**Table G.1 - Main Conversion Table (continued)**

8-bit byte	State 1			State 2			State 3			State 4		
	Code Word		Next	Code Word		Next	Code Word		Next	Code Word		Next
	msb	lsb	State	msb	lsb	State	msb	lsb	State	msb	lsb	State
193	0010010010001000	2	0100010000010000	3	0010010010001000	2	0100010000010000	3				
194	0010010001000100	2	0010010001000100	2	1000001001001000	2	1000001001001000	2				
195	0010010000001000	2	0100010010010010	1	0010010000001000	2	0100010010010010	1				
196	0010001000100100	2	0010001000100100	2	1000001000100100	2	1000001000100100	2				
197	0010001000000100	2	0010001000000100	2	1000001000000100	2	1000001000000100	2				
198	0010001001001000	2	0100010001000010	1	0010001001001000	2	0100010001000010	1				
199	0001001001000100	2	0001001001000100	2	0100001000001000	2	0100001000001000	2				
200	0001000100100100	2	0001000100100100	2	1001000000100000	3	1001000000100000	3				
201	0001000100000100	2	0001000100000100	2	1000100100001000	3	1000100100001000	3				
202	0001001000001000	2	0100010000100001	1	0001001000001000	2	0100010000100001	1				
203	0001000000100000	2	0001000000100000	2	1000100010000100	3	1000100010000100	3				
204	0000100010000100	2	0000100010000100	2	1000010010001000	3	1000010010001000	3				
205	0000100000010000	2	0000100000010000	2	1000010001000100	3	1000010001000100	3				
206	0000100100001000	2	0100001000100010	1	0000100100001000	2	0100001000100010	1				
207	0000010010001000	2	0100001000010001	1	0000010010001000	2	0100001000010001	1				
208	0000010001000100	2	0000010001000100	2	1000001000100100	3	1000001000100100	3				
209	0000010000001000	2	0100000100010010	1	0000010000001000	2	0100000100010010	1				
210	0000001000000100	3	0100000010000010	1	1000010000001000	3	0100000010000010	1				
211	0000001000100100	3	0100000100100100	2	1000001001001000	3	0100000100100100	2				
212	0000001001001000	3	0100000100000100	2	1000001000000100	3	0100000100000100	2				
213	0000010000001000	3	0100000001000001	1	0000010000001000	3	0100000001000001	1				
214	0000010001000100	3	0000010001000100	3	0100001000001000	3	0100001000001000	3				
215	0000010010001000	3	0100000000100000	2	0000010010001000	3	0100000000100000	2				
216	0000100000010000	3	0000100000010000	3	1001001000010000	3	1001001000010000	3				
217	0000100010000100	3	0000100010000100	3	1001000100000100	3	1001000100000100	3				
218	0000100100001000	3	0100000100000100	3	0000100100001000	3	0100000100000100	3				
219	0001000000100000	3	0001000000100000	3	0100000100001001	1	0100000100001001	1				
220	0001000100000100	3	0001000100000100	3	1001001000010000	2	1001001000010000	2				
221	0001000100100100	3	0001000100100100	3	1001000100001000	2	1001000100001000	2				
222	0001001000001000	3	0100000100100100	3	0001001000001000	3	0100000100100100	3				
223	0001001001000100	3	0001001001000100	3	1001001000001000	3	1001001000001000	3				
224	0010001000000100	3	0010001000000100	3	1000100000001000	3	1000100000001000	3				
225	0010001000100100	3	0010001000100100	3	1001001001000010	1	1001001001000010	1				
226	0010001001001000	3	0100001001000100	3	0010001001001000	3	0100001001000100	3				
227	0010010000001000	3	0100100100000100	3	0010010000001000	3	0100100100000100	3				
228	0010010001000100	3	0010010001000100	3	1001000100001000	3	1001000100001000	3				
229	0010010010001000	3	0100000000100000	3	0010010010001000	3	0100000000100000	3				
230	0010000001000000	4	0010000001000000	4	1001001000100001	1	1001001000100001	1				
231	0000001001001001	1	0100100100100010	1	1001000100100010	1	0100100100100010	1				
232	0000001000100010	1	0100100010000100	2	1001000100010001	1	0100100010000100	2				
233	0000001000010001	1	0100100000010000	2	1001000010010010	1	0100100000010000	2				
234	0000000100010010	1	0100000001000000	4	1001000010001001	1	0100000001000000	4				
235	0000000100001001	1	0100100100010001	1	1001000001000010	1	0100100100010001	1				
236	0000000010000010	1	0100100010010010	1	1001000000100001	1	0100100010010010	1				
237	0000000001000001	1	0100100001000010	1	1000100100100001	1	0100100001000010	1				
238	0010010000010010	1	0010010000010010	1	1000100010010001	1	1000100010010001	1				
239	0010001000000010	1	0010001000000010	1	1001000010000100	3	1001000010000100	3				
240	0010010000001001	1	0100100010000100	3	0010010000001001	1	0100100010000100	3				
241	0010000100000001	1	0010000100000001	1	1001000010000100	2	1001000010000100	2				

**Table G.1 - Main Conversion Table (concluded)**

8-bit byte	State 1			State 2			State 3			State 4		
	Code Word		Next	Code Word		Next	Code Word		Next	Code Word		Next
	msb	lsb	State	msb	lsb	State	msb	lsb	State	msb	lsb	State
242	0001001000010010		1	0001001000010010		1	1000000010000000		4	1000000010000000		4
243	0001000100000010		1	0001000100000010		1	1000100001001001		1	1000100001001001		1
244	0001001000001001		1	0100100000100001		1	0001001000001001		1	0100100000100001		1
245	0001000010000001		1	0001000010000001		1	1000100000100010		1	1000100000100010		1
246	0000100100010010		1	0000100100010010		1	1000100000010001		1	1000100000010001		1
247	0000100010000010		1	0000100010000010		1	1000010000010010		1	1000010000010010		1
248	0000100100001001		1	0100010010010001		1	0000100100001001		1	0100010010010001		1
249	0000100001000001		1	0000100001000001		1	1000010000001001		1	1000010000001001		1
250	0000010010010010		1	0000010010010010		1	1000001000000010		1	1000001000000010		1
251	0000010001000010		1	0000010001000010		1	1000000100000001		1	1000000100000001		1
252	0000010010001001		1	0100010000100010		1	0000010010001001		1	0100010000100010		1
253	0000010000100001		1	0000010000100001		1	0100100010001001		1	0100100010001001		1
254	0000001001000100		2	0100010000010001		1	1001000000010000		2	0100010000010001		1
255	0000001000001000		2	0100001000010010		1	1000100100010000		2	0100001000010010		1



**Table G.2 - Substitution table (continued)**

8-bit byte	State 1			State 2			State 3			State 4		
	Code Word		Next	Code Word		Next	Code Word		Next	Code Word		Next
	msb	lsb	State	msb	lsb	State	msb	lsb	State	msb	lsb	State
0	000010010000000	4	000010010000000	4	0100100001001000	2	0100100001001000	2				
1	000010010000000	4	000010010000000	4	0100100001001000	3	0100100001001000	3				
2	000100100000000	4	000100100000000	4	0100100000001001	1	0100100000001001	1				
3	000000100100000	4	0100010000000001	1	1000001000000000	4	0100010000000001	1				
4	000000010010000	3	0100100000000010	1	1001000000000100	3	0100100000000010	1				
5	000000001001000	3	0100001000000000	4	1001000000100100	3	0100001000000000	4				
6	000000000100100	3	0100100000000100	2	1001000001001000	3	0100100000000100	2				
7	000000000100100	2	0100000100000000	4	1001000000000100	2	0100000100000000	4				
8	000000001001000	2	0100100010010000	3	1001000000100100	2	0100100010010000	3				
9	000000010010000	2	0100100000100100	2	1001000001001000	2	0100100000100100	2				
10	000001000100000	4	0000010001000000	4	1001001001000000	4	1001001001000000	4				
11	000010001000000	4	0000100010000000	4	1000100001001000	3	1000100001001000	3				
12	000100010000000	4	0001000100000000	4	0100010001001000	3	0100010001001000	3				
13	001000100000000	4	0010001000000000	4	1000100000000100	3	1000100000000100	3				
14	000000100010000	3	0100100000000100	3	1001000010010000	3	0100100000000100	3				
15	000000010001000	3	0100100010010000	2	1001000100100000	3	0100100010010000	2				
16	000000001000100	3	0100001000000001	1	0100100000001000	3	0100001000000001	1				
17	000000000100010	3	01000010000000010	1	0100100010001000	3	01000010000000010	1				
18	000000000100010	2	0100100000100100	3	1001000010010000	2	0100100000100100	3				
19	000000001000100	2	0100100100100000	3	1001000100100000	2	0100100100100000	3				
20	000000010001000	2	0100100100100000	2	0100010001001000	2	0100100100100000	2				
21	000000100010000	2	0100100000010010	1	0100100000001000	2	0100100000010010	1				
22	0000010010000001	1	0000010010000001	1	1000100000100100	3	1000100000100100	3				
23	0000100100000001	1	0000100100000001	1	1000100010010000	3	1000100010010000	3				
24	0001001000000001	1	0001001000000001	1	0100100010001000	2	0100100010001000	2				
25	0010010000000001	1	0010010000000001	1	1000100000000100	2	1000100000000100	2				
26	0000000001001001	1	010000100000000100	3	1000010000000001	1	010000100000000100	3				
27	0000000010010001	1	01000001000000001	1	1000100000000010	1	01000001000000001	1				
28	0000000100100001	1	010000100000000100	2	10010000000001001	1	010000100000000100	2				
29	0000001001000001	1	01000010000000010	1	10010000000001010	1	01000010000000010	1				
30	000010000100000	4	0000100001000000	4	1000100000100100	2	1000100000100100	2				
31	000100001000000	4	0001000010000000	4	1000100001001000	2	1000100001001000	2				
32	001000010000000	4	0010000100000000	4	01000100000001001	1	01000100000001001	1				
33	000001000010000	3	0000010000100000	3	0100100001001001	1	0100100001001001	1				
34	000000100001000	3	010001000000010010	1	1000100100100000	3	010001000000010010	1				
35	000000010000100	3	0100100000000001	1	10010000000001000	3	0100100000000001	1				
36	000000001000010	3	0100000010000000	4	1001000001000100	3	0100000010000000	4				
37	000001000010000	2	0000010000100000	2	10000010000000001	1	10000010000000001	1				
38	000000001000010	2	0100010000100100	3	1000100010010000	2	0100010000100100	3				
39	000000010000100	2	0100010000100100	2	1000100100100000	2	0100010000100100	2				
40	000000100001000	2	0100100000100010	1	10010000000001000	2	0100100000100010	1				
41	0000010001000001	1	0000010001000001	1	10000100000000010	1	10000100000000010	1				
42	0000010010000010	1	0000010010000010	1	1000000100000000	4	1000000100000000	4				
43	0000100010000001	1	0000100010000001	1	1001000001000100	2	1001000001000100	2				
44	0000100100000010	1	0000100100000010	1	10001000000001001	1	10001000000001001	1				
45	0001000100000001	1	0001000100000001	1	1001000010001000	3	1001000010001000	3				
46	0001001000000010	1	0001001000000010	1	1001000100010000	3	1001000100010000	3				

**Table G.2 - Substitution table (concluded)**

8-bit byte	State 1			State 2			State 3			State 4		
	Code Word		Next	Code Word		Next	Code Word		Next	Code Word		Next
	msb	lsb	State	msb	lsb	State	msb	lsb	State	msb	lsb	State
47	0010001000000001	1	0010001000000001	1	1000100000010010	1	1000100000010010	1				
48	0010010000000010	1	0010010000000010	1	0100010000001000	3	0100010000001000	3				
49	0000000001000010	1	0100100010010001	1	1001000000010001	1	0100100010010001	1				
50	0000000010001001	1	0100100001000100	3	1001000000100010	1	0100100001000100	3				
51	0000000010010010	1	0100010010010000	3	1001000001001001	1	0100010010010000	3				
52	0000000100010001	1	0100010010010000	2	1001000010010001	1	0100010010010000	2				
53	0000000100100010	1	0100100001000100	2	1001000100100001	1	0100100001000100	2				
54	0000001000100001	1	0100100100100001	1	1001001001000001	1	0100100100100001	1				
55	0000001001000010	1	0100100100010000	3	0100001000001001	1	0100100100010000	3				
56	0001000001000000	4	0001000001000000	4	1001001000100000	3	1001001000100000	3				
57	0010000010000000	4	0010000010000000	4	1001000010001000	2	1001000010001000	2				
58	0010010010010000	3	0010010010010000	3	1001000100010000	2	1001000100010000	2				
59	0010010001001000	3	0100100100010000	2	0010010001001000	3	0100100100010000	2				
60	0010010000100100	3	0010010000100100	3	1001001000100000	2	1001001000100000	2				
61	0010010000000100	3	0010010000000100	3	0100001001001000	2	0100001001001000	2				
62	0001001001001000	3	0100000010000001	1	0001001001001000	3	0100000010000001	1				
63	0001001000100100	3	0001001000100100	3	0100001001001000	3	0100001001001000	3				
64	0001001000000100	3	0001001000000100	3	0100010010001000	3	0100010010001000	3				
65	0000100100100100	3	0000100100100100	3	0100100100001000	3	0100100100001000	3				
66	0000100100000100	3	0000100100000100	3	1000010000000100	3	1000010000000100	3				
67	0000100000100000	3	0000100000100000	3	1000010000100100	3	1000010000100100	3				
68	0000010010000100	3	0000010010000100	3	1000010001001000	3	1000010001001000	3				
69	0000010000010000	3	0000010000010000	3	1000010010010000	3	1000010010010000	3				
70	0000001001000100	3	0100001000000100	2	1000100000001000	3	0100001000000100	2				
71	0000001000001000	3	0100100000010000	3	1000100010001000	3	0100100000010000	3				
72	0000000010010010	3	0100010001000100	3	1000100100010000	3	0100010001000100	3				
73	0000000010000100	3	0100001000100100	3	1001000000010000	3	0100001000100100	3				
74	0000010000010000	2	0000010000010000	2	1000100001000100	3	1000100001000100	3				
75	0001001001001000	2	0100001000000100	3	0001001001001000	2	0100001000000100	3				
76	0000010010000100	2	0000010010000100	2	0100010000001000	2	0100010000001000	2				
77	0000100000100000	2	0000100000100000	2	0100010010001000	2	0100010010001000	2				
78	0010010001001000	2	0100000100000010	1	0010010001001000	2	0100000100000010	1				
79	0000100100000100	2	0000100100000100	2	0100100100001000	2	0100100100001000	2				
80	0000100100100100	2	0000100100100100	2	1000010000000100	2	1000010000000100	2				
81	0001001000000100	2	0001001000000100	2	1000010000100100	2	1000010000100100	2				
82	0001001000100100	2	0001001000100100	2	1000010001001000	2	1000010001001000	2				
83	0010010000000100	2	0010010000000100	2	1000010010010000	2	1000010010010000	2				
84	0010010000100100	2	0010010000100100	2	1000100000001000	2	1000100000001000	2				
85	0010010010010000	2	0010010010010000	2	0100010001001001	1	0100010001001001	1				
86	0000000100000100	2	0100001000100100	2	1000100001000100	2	0100001000100100	2				
87	0000000100100100	2	0100010001000100	2	1000100010001000	2	0100010001000100	2				

## Annex H

(normative)

### Burst Cutting Area (BCA)

The BCA is an option available only for Type A and Type C disks, where the application is not a typical video application. If implemented, it shall meet the requirements of this annex.

The purpose of the code recorded in the BCA is to provide a link between the content of a disk and the software to be used with that disk. Therefore, only the structure of this code is specified in this annex and not the content of the data bytes. The latter is to be supplied by the content provider of the disk. The BCA code can be the same for a series of disks or unique for each disk, for instance if it specifies a serial number. The BCA code is recorded after the end of the disk manufacturing process.

The BCA code shall be readable by means of the PUH specified in 9.1. It can be written on the recorded layer of a Type A disk and on Layer 1 of a Type C disk by means of a high-power system such as a YAG laser, a method called “burst cutting”. The BCA code can also be obtained by means of a replication process using embossed pits if the read-out signals satisfy the requirements specified below.

#### H.1 Location of the BCA

The BCA is an annular area which shall extend between diameters  $d_{11}$  and  $d_{12}$  shown in figure 7

$$\begin{aligned}d_{11} &= 44,6 \text{ mm} && +0,0 \text{ mm} \\ & && -0,8 \text{ mm} \\d_{12} &= 47,0 \text{ mm} && +0,1 \text{ mm} \\ & && -0,1 \text{ mm}\end{aligned}$$

According to 10.6 the Lead-in Zone can start within the area defined by  $d_6 = 44,0 \text{ mm max}$  and  $d_7 = 45,2 \text{ mm max}$ . If the BCA is implemented,  $d_7$  shall be restricted to  $44,5 \text{ mm max}$ .

The BCA code shall be written with a series of low reflectance stripes arranged in circumferential direction and extending radially between  $d_{11}$  and  $d_{12}$ , see figure H.1.

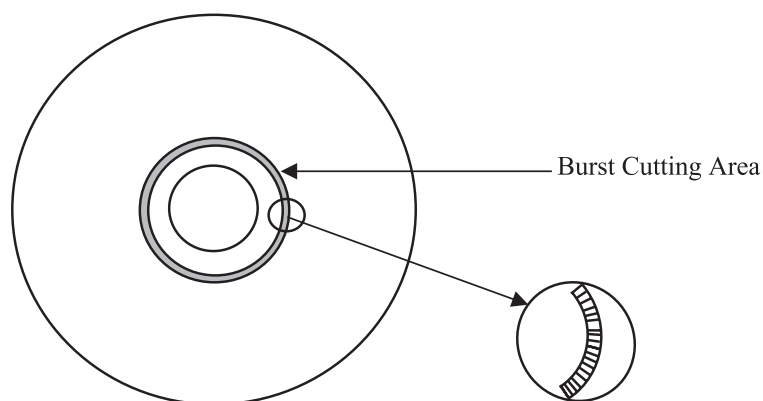

97-0030-A

Figure H.1 - Burst Cutting Area

## H.2 Modulation method

Data intended for the BCA code shall be encoded by phase encoding according to which a ZERO bit is represented by two Channel bits set to ONE ZERO and a ONE bit by two Channel bits set to ZERO ONE. The sequence of Channel bits shall be modulated according to the Return-to-Zero modulation method (see figure H.4). The low reflectance stripes shall be formed corresponding to pulses after the RZ modulation. They shall not exceed half the width of a Channel bit.

## H.3 BCA code structure

The BCA code shall consist of a Preamble, a Data field and a Postamble.

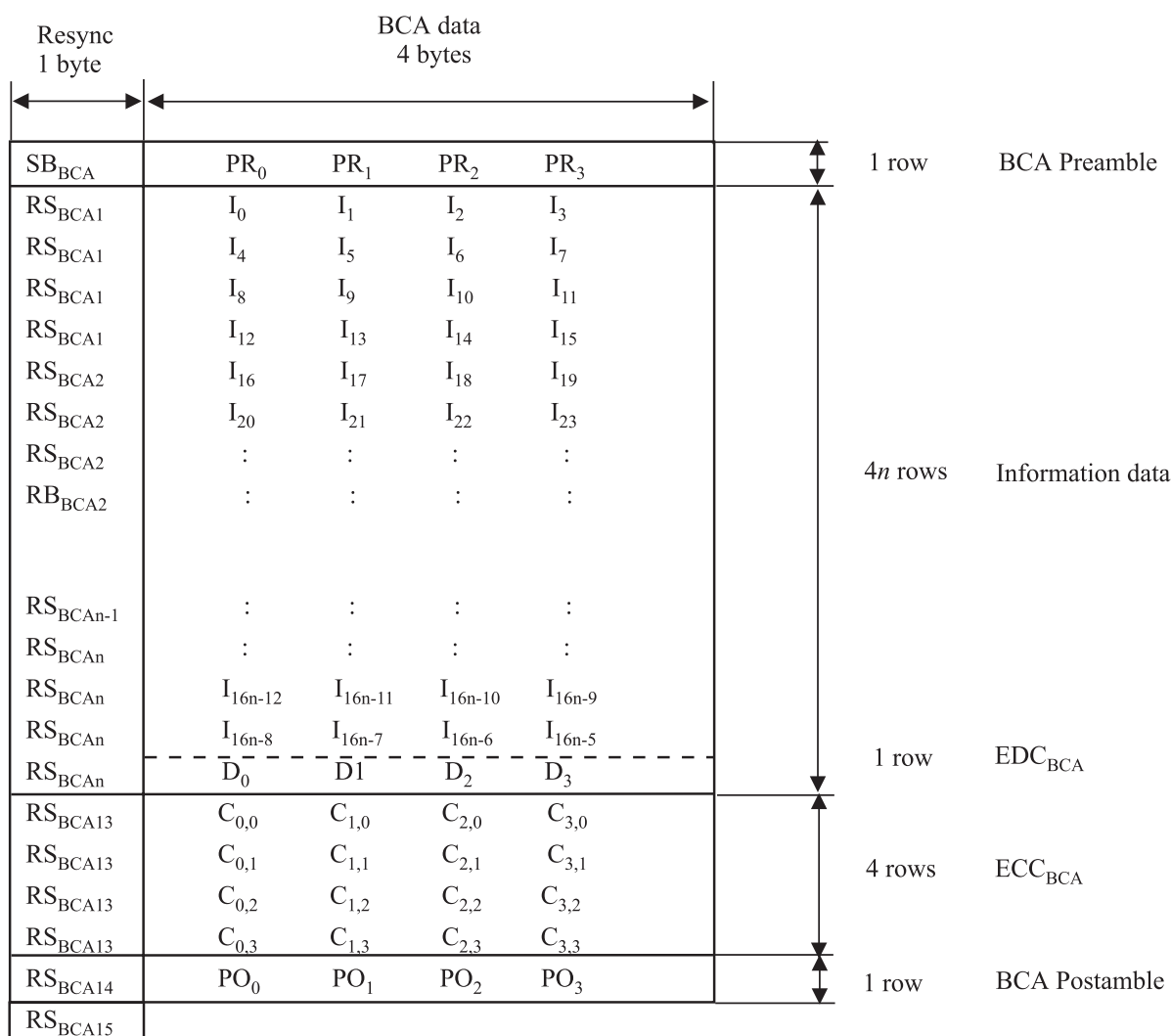

97-0031-A

**Figure H.2 - BCA code structure**

The BCA Preamble shall consist of 4 bytes  $PR_0$  to  $PR_3$  set to (00) preceded by a BCA Sync byte identified as  $SB_{BCA}$ .

The Data field of the BCA shall consists of

- $(16 \times n)-4$  information bytes  $I_0, I_1 \dots I_{16n-5}$
- 4 bytes  $D_0, D_1, D_2$  and  $D_3$  of an error detection code  $EDC_{BCA}$

- 16 bytes  $C_{i,j}$  of an error correction code  $ECC_{BCA}$  recorded in the order  $C_{0,0}$  to  $C_{3,0}$  ;  $C_{0,1}$  to  $C_{3,1}$  ;  $C_{0,2}$  to  $C_{3,2}$  and  $C_{0,3}$  to  $C_{3,3}$
- where  $n$  is an integer such that  $1 \leq n \leq 12$
- a Resync byte  $RS_{BCAi}$  shall be inserted before each 4-byte row of  $I_i$  bytes, changing every 4th row (see figure H.3)

The BCA Postamble shall consist of 4 bytes  $PO_0$  to  $PO_3$  set to (55) and preceded by Resync byte  $RS_{BCA14}$  and followed by Resync byte  $RS_{BCA15}$ .

#### H.4 Error Detection Code $EDC_{BCA}$

The 4 bytes  $D_0$  to  $D_3$  shall follow the information bytes  $I_i$ . Polynomials  $EDC_{BCA}(x)$  and  $I_{BCA}(x)$  shall be as follows.

$$EDC_{BCA}(x) = \sum_{i=0}^{31} b_i x^i$$

$$I_{BCA}(x) = \sum_{i=32}^{128n-1} b_i x^i$$

where  $i$  is the bit number starting with 0 and counted from the lsb of the last byte of  $EDC_{BCA}$  to the msb of the first byte of information data. The value of the  $i$ -th bit is represented by  $b_i$ . The polynomial  $EDC_{BCA}(x)$  shall be calculated as follows

$$EDC_{BCA}(x) = I_{BCA}(x) \bmod G(x)$$

where  $G(x) = x^{32} + x^{31} + x^4 + 1$

#### H.5 BCA Error Correction Code $ECC_{BCA}$

A Reed-Solomon ECC code with a 4-way interleave shall be applied to the information data and the  $EDC_{BCA}$  Polynomials  $R_{BCAj}(x)$  and  $I_{BCAj}(x)$  shall be as follows.

$$R_{BCAj}(x) = \sum_{i=0}^3 C_{j,i} x^{3-i}$$

$$I_{BCAj}(x) = \sum_{i=0}^{4n-2} I_{(j+4i)} x^{51-i} + D_j x^{52-4n}$$

Where  $I_m$  represents the  $m$ -th information data byte and  $D_k$  represents the  $k$ -th  $EDC_{BCA}$  byte.

The polynomial  $R_{BCAj}(x)$  shall be calculated as follows:

$$R_{BCAj}(x) = I_{BCAj}(x) \bmod G_{pBCA}(x)$$

$$G_{pBCA}(x) = \prod_{k=0}^3 (x + \alpha^k)$$

where  $\alpha$  is the primitive root of the polynomial  $G_p(x) = x^8 + x^4 + x^3 + x^2 + 1$

### H.6 Bit pattern of the SB<sub>BCA</sub> byte and of the RS<sub>BCA</sub> bytes

The BCA Sync byte SB<sub>BCA</sub> and the Resync bytes RS<sub>BCA*i*</sub> shall have the patterns shown in figure H.3

Sync byte and Resync bytes	1 byte											
	Bit patterns											
	Fixed pattern								Sync code			
	8 Channel bits								4 Data bits			
	Ch15	Ch14	Ch13	Ch12	Ch11	Ch10	Ch9	Ch8	b3	b2	b1	b0
SB <sub>BCA</sub>	0	1	0	0	0	1	1	0	0	0	0	0
RS <sub>BCA1</sub>	0	1	0	0	0	1	1	0	0	0	0	1
RS <sub>BCA2</sub>	0	1	0	0	0	1	1	0	0	0	1	0
RS <sub>BCA3</sub>	0	1	0	0	0	1	1	0	0	0	1	1
RS <sub>BCA4</sub>	0	1	0	0	0	1	1	0	0	1	0	0
RS <sub>BCA5</sub>	0	1	0	0	0	1	1	0	0	1	0	1
RS <sub>BCA6</sub>	0	1	0	0	0	1	1	0	0	1	1	0
RS <sub>BCA7</sub>	0	1	0	0	0	1	1	0	0	1	1	1
RS <sub>BCA8</sub>	0	1	0	0	0	1	1	0	1	0	0	0
RS <sub>BCA9</sub>	0	1	0	0	0	1	1	0	1	0	0	1
RS <sub>BCA10</sub>	0	1	0	0	0	1	1	0	1	0	1	0
RS <sub>BCA11</sub>	0	1	0	0	0	1	1	0	1	0	1	1
RS <sub>BCA12</sub>	0	1	0	0	0	1	1	0	1	1	0	0
RS <sub>BCA13</sub>	0	1	0	0	0	1	1	0	1	1	0	1
RS <sub>BCA14</sub>	0	1	0	0	0	1	1	0	1	1	1	0
RS <sub>BCA15</sub>	0	1	0	0	0	1	1	0	1	1	1	1
	Recorded in RZ modulation								Recorded in PE-.RZ modulation			

97-0032-A

Figure H.3 - Bit patterns of the SB<sub>BCA</sub> byte and the RS<sub>BCA</sub> bytes

### H.7 BCA Signal specification

The read-out signal from the BCA shall meet the following requirements (figure H.4) .

- The amplitude level  $I_s$  which is the signal corresponding to a low-reflectance stripe shall not exceed  $I_{14L}$  or  $I_{14H} / 5$ .
- The Channel bit length of a BCA Channel bit, expressed in microseconds, shall be 8,89  $\mu$ s at a rotational speed of 1 440 rpm ( 24 Hz).
- An edge position of the BCA signal shall be the position at which the BCA signal crosses the mean level between  $I_s$  and  $I_{14H}$

- The length of pulses corresponding to the low-reflectance stripe shall be  $3,00 \mu\text{s} \pm 1,50 \mu\text{s}$ .
- The deviation of the time interval between successive leading edges shall not exceed  $2,00 \mu\text{s}$ .
- The deviation of the time interval between the centres of successive pulses shall not exceed  $1,50 \mu\text{s}$ . The centre of a pulse shall be the middle point between the leading edge and the trailing edge.

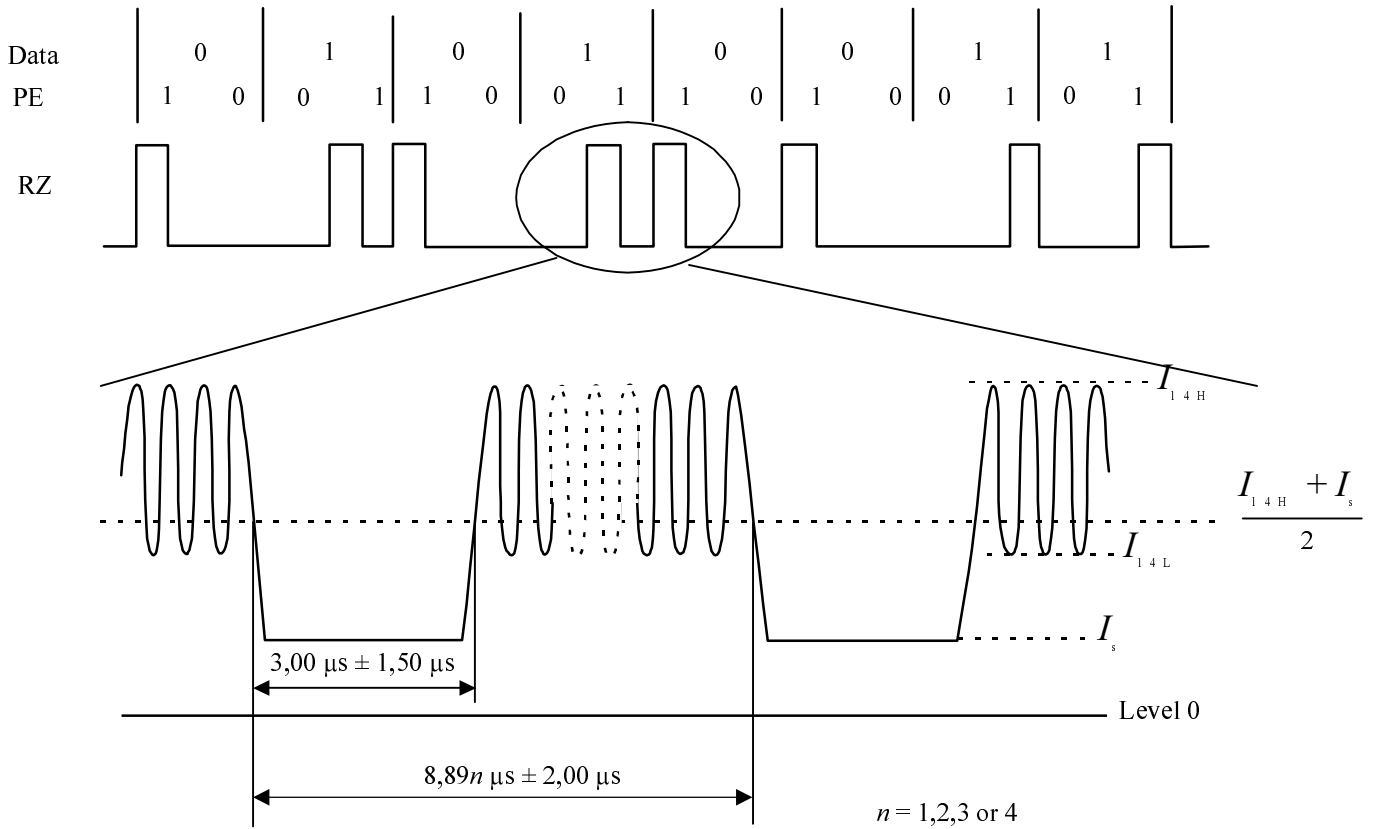

**Figure H.4 - Read-out signal from the BCA**





## **Annex J**

(informative)

### **Transportation**

#### **J.1 General**

As transportation occurs under a wide range of temperature and humidity variations, for differing periods, by many methods of transport and in all parts of the world, it is not possible to specify mandatory conditions for transportation or for packaging.

#### **J.2 Packaging**

The form of packaging should be agreed between sender and recipient or, in absence of such an agreement, is the responsibility of the sender. It should take into account the following hazards.

##### **J.2.1 Temperature and humidity**

Insulation and wrapping should be designed to maintain the conditions for storage over the estimated period of transportation.

##### **J.2.2 Impact loads and vibrations**

- a) Avoid mechanical loads that would distort the shape of the disk.
- b) Avoid dropping the disk.
- c) Disks should be packed in a rigid box containing adequate shock-absorbent material.
- d) The final box should have a clean interior and a construction that provides sealing to prevent the ingress of dirt and moisture.



## Annex K

(informative)

### Measurement of the thickness of the spacer of Dual Layer disks

This annex indicates two convenient methods for measuring the thickness of the spacer which is the layer of transparent material between Layer 0 and Layer 1 of Dual Layer disks.

#### K.1 Laser focusing method

Laser is focused sequentially on each recorded layer by means of an objective lens. The distance by which the lens must be moved equals the thickness of the spacer. As an example, figure K.1 shows schematically an implementation of a Type C disk.

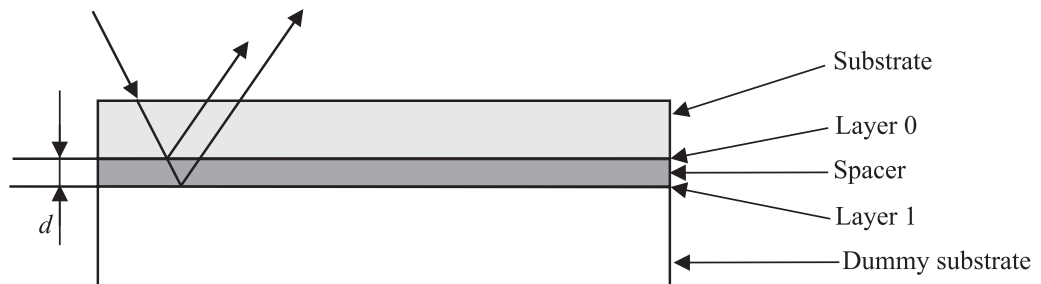

97-0016-A

Figure K.1 - Measurement of the thickness of the spacer

#### K.2 Interferometer method

Light with varying wavelength is used with a Dual Layer disk (figure K.2). The thickness  $d$  of the spacer of known index of refraction  $n$  is determined by measuring the phase difference between the reflected light from Layer 0 and from Layer 1.

The thickness is obtained from the relation

$$d = \frac{\lambda_1 \times \lambda_2}{2n(\lambda_2 - \lambda_1)}$$

where  $n$  is the index of refraction of the spacer.

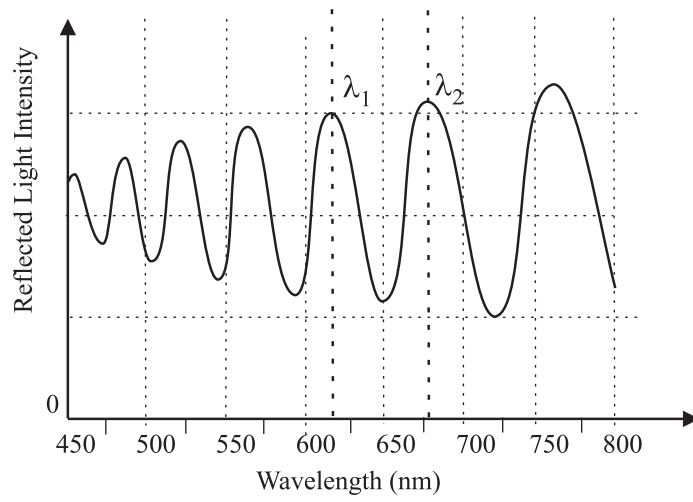

97-0017-A

**Figure K.2 - Reflected light intensity**

## Annex L

(informative)

### Values to be implemented in existing and future specifications

The values for bytes which this ECMA Standard specifies are related to DVD disks which are in conformance with this ECMA Standard, viz. DVD - Read-Only disks. It is expected that other categories of DVD disks will be standardized in future. It is therefore recommended that the following values be used for these other DVD disks. Where further possible bit patterns are not specified, they are intended for future standardization and should not be used.

#### Identification Data

Bits b <sub>0</sub> to b <sub>23</sub>	shall specify the Sector Number
Bit b <sub>24</sub>	shall be set to ZERO on Layer 0 of DL disks ONE on Layer 1 of DL disks ZERO on SL disks
Bit b <sub>25</sub>	shall be set to ZERO, indicating read-only data ONE, indicating other than read-only data
Bits b <sub>26</sub> and b <sub>27</sub>	shall be set to ZERO ZERO in the Data Zone ZERO ONE in the Lead-in Zone ONE ZERO in the Lead-out Zone ONE ONE in the Middle Zone
Bit b <sub>28</sub>	shall be set to ZERO
Bit b <sub>29</sub>	shall be set to ZERO if the reflectivity is greater than 40 % with PBS PUH ONE if the reflectivity is 40 % max. with PBS PUH
Bit b <sub>30</sub>	shall be set to ZERO, indicating pit tracking ONE, indicating groove tracking
Bit b <sub>31</sub>	shall be set to ZERO, indicating CLV format on Read-Only and Recordable disks ONE, indicating Zoned format for Rewritable disks

#### Physical format information in the Lead-in Zone

##### Byte 0 - Disk Category and Version Number

Bits b<sub>0</sub> to b<sub>3</sub> shall specify the Version Number

if set to 0000, they specify Version 0.9 for test use only of the *DVD specifications for Read-Only Disc*

if set to 0001, they specify this ECMA Standard

Bits b<sub>4</sub> to b<sub>7</sub> shall specify the Disk Category

if set to 0000, they indicate a read-only disk

if set to 0001, they indicate a rewritable disk

if set to 0010, they specify a recordable disk

### Byte 1 - Disk size and maximum transfer rate

Bits b<sub>0</sub> to b<sub>3</sub> shall specify the maximum transfer rate

if set to 0000, they specify a maximum transfer rate of 2,52 Mbits/s

if set to 0001, they specify a maximum transfer rate of 5,04 Mbits/s

if set to 0010, they specify a maximum transfer rate of 10,08 Mbits/s

Bits b<sub>4</sub> to b<sub>7</sub> shall specify the disk size

if set to 0000, they specify a 120 mm disk

if set to 0001, they specify an 80 mm disk

### Byte 2 - Disk structure

Bits b<sub>0</sub> to b<sub>3</sub> specify the layer type

if set to 0001, they specify a read-only layer

if set to another bit pattern, the following rules shall be applied

bit b<sub>0</sub>            if set to  
                    ZERO, shall specify that the disk does not contain embossed Data Zones  
                    ONE, shall specify that the disk contains embossed Data Zones

Bit b<sub>1</sub>            if set to  
                    ZERO, shall specify that the disk does not contain recordable Data Zones  
                    ONE, shall specify that the disk contains recordable Data Zones

Bit b<sub>2</sub>            if set to  
                    ZERO, shall specify that the disk does not contain re-writable Data Zones  
                    ONE, shall specify that the disk contains re-writable Data Zones

Bit b<sub>3</sub>            shall be set to ZERO

Bit b<sub>4</sub> shall specify the track path

if set to ZERO, it specifies PTP on DL disks or an SL disk

if set to ONE, it specifies OTP on DL disks

Bits b<sub>5</sub> and b<sub>6</sub> shall specify the disk Type

if set to 00, they specify Type A or Type B

if set to 01, they specify Type C or Type D

Bit b<sub>7</sub> shall be set to ZERO.

### Byte 3 - Recording density

Bits b<sub>0</sub> to b<sub>3</sub> shall specify the average track pitch

if set to 0000, they indicate a track pitch of 0,74 μm

if set to 0001, they indicate a track pitch of 0,80 μm

Bits b<sub>4</sub> to b<sub>7</sub> shall specify the average Channel bit length

if set to 0000, they specify 0,133 μm

if set to 0001, they specify 0,147 μm

if set to 0010, they indicate that this average length is in the range 0,205 μm to 0,218 μm

#### NOTE

*A recordable disk is a disk on which the information, once recorded by means of inherently irreversible writing effects can not be altered or erased, and in which attempted modifications of the recorded information are detectable. Further information can be appended to already recorded information.*

*A re-writable disk is a disk on which information can be recorded, updated, erased and recorded again.*

## **Annex M**

(informative)

### **Note on the Reference Code**

The purpose of the Reference Code is to provide Channel bit patterns that generates (3T-6T-7T) separating signals. A drive may use these signals to adjust the equalizer for reading HF signals. This annex describes a practical method for generating the required Channel bit patterns.

As described in Section 4, Main Data is scrambled before generating ECC bytes. In order to get, after scrambling and ECC bytes generation but just before modulation, a specific data pattern that will generate 3T, 6T and 7T modulated channel signals, pre-scrambling is applied to the Main Data. If the pre-scrambling data is the same as the normal scrambling data used by the encoding process described in this ECMA Standard, then the same scrambling data is added twice to the user data and non-scrambled data appears just before generating the ECC bytes. This means that the Recording Frames contain fixed data patterns which are duplicates of the Main Data, except for the ECC bytes. The pre-scrambling data is added to all 32 Data Frames used in the Reference Code Zone, except to the first 160 Main Data bytes of the first Data Frame in each ECC Block, so as to avoid large DSV values.

The following steps show how to process the Main Data intended for the Reference Code before it is fed into the encoding system.

#### **Step 1**

Set all Main Data bytes of the 32 Data Frames to (AC).

#### **Step2**

This step is applied to the Data Frames intended for Physical Sectors with Sector Numbers 192 512, (02F000) to 192 543, (02F01F).

To Physical Sectors with Sector Numbers from 192 512 (02F000) to 192 527 (02F00F) add the pre-scrambling data, generated using the scrambling procedure of clause 17 with the initial pre-set number (0) to all Main Data bytes, except the first 160 of the Physical Sector with Sector Number 192 512, (02F000).

To Physical Sectors with Sector Numbers from 192 528, (02F010) to 192 543, (02F01F) add the pre-scrambling data, generated using the scrambling procedure of clause 17 with the initial pre-set number (1), to all Main Data bytes, except the first 160 such bytes of the Physical Sector with Sector Number 192 528, (02F010).





Printed copies can be ordered from:

**ECMA**

114 Rue du Rhône  
CH-1204 Geneva  
Switzerland

Fax: +41 22 849.60.01

Internet: [helpdesk@ecma.ch](mailto:helpdesk@ecma.ch)

Files can be downloaded from our FTP site, [ftp.ecma.ch](ftp://ftp.ecma.ch), logging in as **anonymous** and giving your E-mail address as **password**. This Standard is available from library **ECMA-ST** as a compacted, self-expanding file in MSWord 6.0 format (file E267-DOC.EXE) and as an Acrobat PDF file (file E267-PDF.PDF). File E267-EXP.TXT gives a short presentation of the Standard.

Our web site, <http://www.ecma.ch>, gives full information on ECMA, ECMA activities, ECMA Standards and Technical Reports.

**ECMA**

**114 Rue du Rhône  
CH-1204 Geneva  
Switzerland**

**This Standard ECMA-267 is available free of charge in printed form and as a file.**

**See inside cover page for instructions.**