

Standard ECMA-337

3rd Edition / December 2005

**Data Interchange on
120 mm and 80 mm
Optical Disk using
+RW Format - Capacity:
4,7 and 1,46 Gbytes per
Side**

(Recording speed up to 4X)

Standard

Standard
ECMA-337

3rd Edition / December 2005

**Data Interchange on
120 mm and 80 mm
Optical Disk using
+RW Format - Capacity:
4,7 and 1,46 Gbytes per
Side**

(Recording speed up to 4X)

Brief history

Ecma Technical Committee TC31 was established in 1984 for the standardization of Optical Disks and Optical Disk Cartridges (ODC). Since its establishment, the Committee has made major contributions to ISO/IEC toward the development of International Standards for 80 mm, 90 mm, 120 mm, 300 mm, and 356 mm media. Numerous standards have been developed by TC31 and published by Ecma, almost all of which have also been adopted by ISO/IEC under the fast-track procedure as International Standards.

In February 2002 a group of Companies proposed to TC31 to develop a standard for 120 mm rewritable optical disks using Phase Change recording technology and based on the DVD - Read-Only standard (ECMA-267) and the +RW format (ECMA-274). TC31 adopted this project and started the work that has resulted in the first edition of ECMA-337.

This Ecma Standard specifies two Types of rewritable optical disks, one (Type S) making use of recording on only a single side of the disk and yielding a nominal capacity of 4,7 or 1,46 Gbytes per disk and the other (Type D) making use of recording on both sides of the disk and yielding a nominal capacity of 9,4 or 2,92 Gbytes per disk.

In April 2003 a proposal was made to TC31 to update this Ecma Standard for recording speeds up to 4 times the Reference velocity. TC31 adopted this project which has resulted in the second edition of ECMA-337.

In February 2005 a proposal was made to TC31 to update this Ecma Standard to facilitate the application of the Video Content Protection System.

This Ecma Standard, taken together with a standard for volume and file structure, such as for instance developed in Ecma Technical Committee TC15, provides the requirements for information interchange between systems.

This Ecma Standard has been adopted by the General Assembly of December 2005.

Table of contents

Section 1 - General	1
1 Scope	1
2 Conformance	1
2.1 Optical Disk	1
2.2 Generating system	1
2.3 Receiving system	1
2.4 Compatibility statement	1
3 References	2
4 Definitions	2
4.1 Channel bit	2
4.2 Clamping Zone	2
4.3 Digital Sum Value (DSV)	2
4.4 Disk Reference Plane	2
4.5 dummy substrate	2
4.6 entrance surface	2
4.7 field	2
4.8 groove	3
4.9 interleaving	3
4.10 mark	3
4.11 phase change	3
4.12 Physical Sector	3
4.13 recording layer	3
4.14 Reed-Solomon code (RS)	3
4.15 space	3
4.16 substrate	3
4.17 track	3
4.18 track pitch	3
4.19 VCPS	3
4.20 wobble	3
4.21 zone	4
5 Conventions and notations	4
5.1 Representation of numbers	4

5.2	Names	4
6	List of acronyms	4
7	General description of the optical disk	5
8	General Requirements	6
8.1	Environments	6
8.1.1	Test environment	6
8.1.2	Operating environment	6
8.1.3	Storage environment	7
8.1.4	Transportation	7
8.2	Safety requirements	7
8.3	Flammability	7
9	Reference Drive	7
9.1	Optical system	7
9.2	Optical beam	8
9.3	Read channel 1	9
9.4	Disk clamping	9
9.5	Rotation of the disk	9
9.6	Wobble channel (Read channel 2)	10
9.7	Tracking channel (Read channel 2)	10
9.8	Reference servo systems	10
9.8.1	Normalized servo transfer function	10
9.8.2	Reference Servo for Axial Tracking	11
9.8.3	Reference Servo for Radial Tracking	12
Section 2 - Dimensional, mechanical and physical characteristics of the disk		13
10	Dimensional characteristics	13
10.1	Reference Planes	14
10.2	Overall dimensions	14
10.3	First transition area	14
10.4	Second transition area	15
10.5	Clamping Zone	15
10.6	Third transition area	15
10.7	Information Zone	15
10.8	Rim area	15
10.9	Remark on tolerances	16
11	Mechanical characteristics	16

11.1	Mass	16
11.2	Moment of inertia	16
11.3	Dynamic imbalance	16
11.4	Axial runout	16
11.5	Radial runout	16
12	Optical characteristics in the Information Zone	17
12.1	Index of refraction	17
12.2	Thickness of the substrate	17
12.3	Reflectivity	17
12.4	Birefringence	17
12.5	Angular deviation	18
	Section 3 - Format of information	19
13	Data format	19
13.1	Data Frames	19
13.1.1	Identification Data (ID)	20
13.1.2	ID Error Detection Code (IED)	20
13.1.3	RSV	20
13.1.4	Error Detection Code (EDC)	21
13.2	Scrambled Frames	21
13.3	ECC Blocks	22
13.4	Recording Frames	23
13.5	Modulation and NRZI conversion	23
13.6	Physical Sectors	24
13.7	Layout of a Recording UNit (RUN)	25
13.7.1	Recording Unit position	26
13.8	d.c. component suppression control	26
14	Track format	28
14.1	Track shape	28
14.2	Track path	28
14.3	Track pitch	28
14.4	Track layout	28
14.4.1	ADIP information	28
14.4.2	Physical format information in ADIP	32
	Section 4 - Format of the Information Zone	48
15	General description of the Information Zone	48

16	Layout of the Information Zone	48
16.1	Physical Sector Numbers (PSNs)	49
17	Lead-in Zone	49
17.1	Initial Zone	49
17.2	Inner Disk Test Zone	49
17.3	Inner Drive Test Zone	49
17.4	Guard Zone 1	49
17.5	Reserved Zone 1	49
17.6	Reserved Zone 2	50
17.7	Inner Disk Identification Zone	50
17.8	Reserved Zone 3	50
17.9	Reference Code Zone	51
17.10	Buffer Zone 1	51
17.11	Control Data Zone	51
17.11.1	Physical format information	51
17.11.2	Disk manufacturing information	53
17.11.3	Content provider information	53
17.12	Buffer Zone 2	53
18	Data Zone	53
19	Lead-out Zone	53
19.1	Buffer Zone 3	53
19.2	Outer Disk Identification Zone	53
19.3	Guard Zone 2	53
19.4	Reserved Zone 4	54
19.5	Outer Drive Test Zone	54
19.6	Outer Disk Test Zone	54
19.7	Guard Zone 3	54
20	Assignment of Logical Sector Numbers (LSNs)	54
21	Formatting	54
21.1	Pre-formatting	55
21.1.1	Verification	55
21.2	Background formatting	55
21.2.1	Initialization	56
21.2.2	De-icing	56
21.2.3	Finalization	56
21.2.4	Verification (optional)	56

21.3	Sequential recording without formatting	56
22	Disk Control Blocks	57
22.1	General format of Disk Control Blocks	57
22.2	Format of the Formatting DCB (FDCB)	59
22.3	Format of the Write inhibit DCB (WDCB)	63
Section 5 - Characteristics of the groove		65
23	General	65
24	Method of testing	65
24.1	Environment	65
24.2	Reference Drive	65
24.2.1	Optics and mechanics	65
24.2.2	Read power	65
24.2.3	Read channels	65
24.2.4	Tracking	65
24.3	Definition of signals	66
25	Characteristics of the groove signals	67
25.1	Phase depth	67
25.2	Push-pull signal	67
25.3	Track Cross signal	67
25.4	Normalized wobble signal	67
25.5	Characteristics of the wobble	67
Section 6 - Characteristics of the recording layer		68
26	Method of testing	68
26.1	Environment	68
26.2	Reference Drive	68
26.2.1	Optics and mechanics	68
26.2.2	Read power	68
26.2.3	Read channels	68
26.2.4	Tracking	68
26.2.5	Scanning velocity	68
26.3	Write conditions	69
26.3.1	Write pulse waveform	69
26.3.2	Write power	69
26.4	Measurement conditions	69
27	Characteristics of the recorded signals	70

27.1	Channel bit length	70
27.2	Definition of signals	70
27.2.1	High frequency signals (HF)	70
27.2.2	Modulated amplitude	70
27.2.3	Signal asymmetry	71
27.2.4	Normalized Slicing Level jump	71
27.2.5	Jitter	71
27.2.6	Track Cross signal	71
27.3	Read stability	71
28	Additional testing conditions	72
28.1	Test environment	72
28.1.1	Optics	72
28.2	Definition of signals	72
28.2.1	Modulated amplitude	72
28.2.2	Signal asymmetry	72
28.2.3	Jitter	72
28.2.4	Track Cross signal	73
28.2.5	Differential phase tracking error signal	73
28.2.6	Tangential push-pull signal	74
29	Quality of the recording layer	74
29.1	Defects	74
29.2	Data errors	74
	Section 7 - Characteristics of user data	75
30	Method of testing	75
30.1	Environment	75
30.2	Reference Drive	75
30.2.1	Optics and mechanics	75
30.2.2	Read power	75
30.2.3	Read channels	75
30.2.4	Error correction	75
30.2.5	Tracking	75
31	Minimum quality of a Recording Unit	76
31.1	Tracking	76
31.2	User-written data	76
	Annex A (normative) 80 mm disk	77
	Annex B (normative) Structure for Extended format information in the Data Zone	81

Annex C (normative) Measurement of light reflectivity	85
Annex D (normative) Measurement of birefringence	87
Annex E (normative) Measuring conditions for operation signals	89
Annex F (normative) Measurement of the differential phase tracking error	93
Annex G (normative) The write pulse wave form for testing	97
Annex H (normative) 8-to-16 Modulation	101
Annex I (normative) Optimum Power Control	109
Annex J (normative) Logical to Physical address translation	113
Annex K (informative) Measurement of the groove wobble amplitude	115
Annex L (informative) Transportation	117
Annex M (informative) Defect Management and Physical Formatting	119
Annex N (informative) Video Content Protection System	121
Annex O (informative) How to use the Physical format information in ADIP	123
Annex P (informative) Values to be Implemented in Existing and Future Specifications	125



Section 1 - General

1 Scope

This Ecma Standard specifies the mechanical, physical and optical characteristics of 120 mm rewritable optical disks with capacities of 4,7 Gbytes and 9,4 Gbytes. It specifies the quality of the recorded and unrecorded signals, the format of the data and the recording method, thereby allowing for information interchange by means of such disks. The data can be written, read and overwritten many times using the phase change method. These disks are identified as +RW.

This Ecma Standard also specifies 80 mm disks with capacities of 1,46 Gbytes and 2,92 Gbytes. These disks shall have the same characteristics as the 120 mm disks, except for some parameters related to the smaller dimensions. All parameters unique for the 80 mm disks are specified in Annex A.

This Ecma Standard specifies

- two related but different Types of this disk (see Clause 7),
- the conditions for conformance,
- the environments in which the disk is to be tested, operated and stored,
- the mechanical, physical and dimensional characteristics of the disk, so as to provide mechanical interchange between data processing systems,
- the format of the information on the disk, including the physical disposition of the tracks and sectors, the error correcting codes and the coding method,
- the characteristics of the signals recorded on the disk, thus enabling data processing systems to read the data from the disk.

This Ecma Standard provides for the interchange of disks between optical disk drives. Together with a standard for volume and file structure, it provides for full data interchange between data processing systems.

2 Conformance

2.1 Optical Disk

A claim of conformance with this Ecma Standard shall specify the Type implemented. An optical disk shall be in conformance with this Ecma Standard if it meets all mandatory requirements specified for its Type.

2.2 Generating system

A generating system shall be in conformance with this Ecma Standard if the optical disk it generates is in accordance with 2.1.

2.3 Receiving system

A receiving system shall be in conformance with this Ecma Standard if it is able to handle both Types of optical disk according to 2.1.

2.4 Compatibility statement

A claim of conformance by a Generating or Receiving system with this Ecma Standard shall include a statement listing any other standards supported. This statement shall specify the numbers of the standards, the optical disk types supported (where appropriate) and whether support includes reading only or both reading and writing.

3 References

ECMA-43	8-bit Coded Character Set Structure and Rules (ISO/IEC 4873: 1991)
ECMA-267	120 mm DVD – Read-Only Disk (ISO/IEC 16448: 2002)
ECMA-268	80 mm DVD – Read-Only Disk (ISO/IEC 16449: 2002)
ECMA-287	Safety of Electronic Equipment
ECMA-349	Data Interchange on 120 mm and 80 mm Optical Disk using +R Format - Capacity: 4,7 and 1,46 Gbytes per Side (Recording speed up to 16x) (ISO/IEC 17344: 2005)
ECMA-364	Data Interchange on 120 mm and 80 mm Optical Disk using +R DL Format - Capacity: 8,55 and 2,66 Gbytes per Side (Recording speed 2,4x) (ISO/IEC 25434 currently under ballot process)
ECMA-371	Data Interchange on 120 mm and 80 mm Optical Disk using +RW HS Format - Capacity: 4,7 and 1,46 Gbytes per Side (Recording speed up to 8x) (not yet adopted by the Ecma General Assembly)

The efficiency and data reliability of +RW disks can be improved by the use of Background Formatting and Defect Management. An example of such a system is referred to in Annex M.

Unauthorized copying and/or redistribution of video data that is recorded in the DVD+R/+RW Video Format can be prevented by applying the Video Content Protection System as referred to in Annex N.

4 Definitions

For the purpose of this Ecma Standard the following definitions apply:

4.1 Channel bit

The elements by which the binary values ZERO and ONE are represented by marks and spaces on the disk.

4.2 Clamping Zone

The annular part of the disk within which the clamping force is applied by the clamping device.

4.3 Digital Sum Value (DSV)

The arithmetic sum obtained from a bit stream by allocating the decimal value +1 to bits set to ONE and the decimal value -1 to bits set to ZERO.

4.4 Disk Reference Plane

A plane defined by the perfectly flat annular surface of an ideal spindle onto which the clamping Zone of the disk is clamped, and which is normal to the axis of rotation.

4.5 dummy substrate

A layer which may be transparent or not, provided for the mechanical support of the disk and, in some cases, of the recording layer as well.

4.6 entrance surface

The surface of the disk onto which the optical beam first impinges.

4.7 field

A subdivision of a sector.

4.8 groove

A trench-like feature of the disk, applied before the recording of any information, and used to define the track location. The groove is located nearer to the entrance surface than the so-called land in between the grooves. The recording is made on the groove.

4.9 interleaving

The process of reallocating the physical sequence of units of data so as to render the data more immune to burst errors.

4.10 mark

A feature of the recording layer which may take the form of an amorphous domain, a pit, or any other type or form that can be sensed by the optical system. The pattern of marks and spaces represents the data on the disk.

4.11 phase change

A physical effect by which the area of a recording layer irradiated by a laser beam is heated so as to change from an amorphous state to a crystalline state and vice versa.

4.12 Physical Sector

The smallest addressable part of a track in the Information Zone of a disk that can be accessed independently of other addressable parts of the Zone.

4.13 recording layer

A layer of the disk on which data is written during manufacture and / or use.

4.14 Reed-Solomon code (RS)

An error detection and / or correction code.

4.15 Reference velocity

The Reference velocity is the linear velocity that results in the nominal Channel bit rate of 26,156 25 Mbit/s.

4.16 space

A feature of the recording layer which may take the form of a crystalline, a non-pit, or any other type or form that can be sensed by the optical system. The pattern of marks and spaces represents the data on the disk.

4.17 substrate

A transparent layer of the disk, provided for mechanical support of the recording layer, through which the optical beam accesses the recording layer.

4.18 track

A 360° turn of a continuous spiral.

4.19 track pitch

The distance between adjacent track centrelines, measured in a radial direction.

4.20 VCPS

VCPS (Video Content Protection System) defines a method to prevent unauthorized copying and/or redistribution of video data that is recorded in the DVD+R/+RW Video Format.

4.21 wobble

A continuous sinusoidal deviation of the track from the average centreline. Location information is included as phase modulated data in the wobble.

4.22 zone

An annular area of the disk.

5 Conventions and notations

5.1 Representation of numbers

A measured value is rounded off to the least significant digit of the corresponding specified value. For instance, it implies that a specified value of 1,26 with a positive tolerance of + 0,01 and a negative tolerance of - 0,02 allows a range of measured values from 1,235 to 1,274.

Numbers in decimal notations are represented by the digits 0 to 9.

Numbers in hexadecimal notation are represented by the hexadecimal digits 0 to 9 and A to F in parentheses.

The setting of bits is denoted by ZERO and ONE.

Numbers in binary notations and bit patterns are represented by strings of digits 0 and 1, with the most significant bit shown to the left. In a pattern of n bits, bit $b_{(n-1)}$ shall be the most significant bit (msb) and bit b_0 shall be the least significant bit (lsb). Bit $b_{(n-1)}$ shall be recorded first.

Negative values of numbers in binary notation are given as Two's complement.

In each data field, the data is recorded so that the most significant byte (MSB), identified as Byte 0, shall be recorded first and the least significant byte (LSB) last.

In a field of $8n$ bits, bit $b_{(8n-1)}$ shall be the most significant bit (msb) and bit b_0 the least significant bit (lsb). Bit $b_{(8n-1)}$ shall be recorded first.

5.2 Names

The names of entities, e.g. specific tracks, fields, etc., are given with an initial capital.

6 List of acronyms

a.c.	alternating current
ADIP	Address in Pre-groove
ASM	Asymmetry
BP	Byte Position
BPF	Band Pass Filter
CAV	Constant Angular Velocity
CLD	Constant Linear Density
CLV	Constant Linear Velocity
d.c.	direct current
DCB	Disk Control Block
DCC	d.c. Component suppression Control
DOW	Direct OverWrite
DSV	Digital Sum Value
ECC	Error Correction Code
EDC	Error Detection Code
EI	Extended Information
FDCB	Formatting DCB
HF	High Frequency
ID	Identification Data
IED	ID Error Detection code
LPF	Low Pass filter

LSB	Least Significant Byte
lsb	Least Significant Bit
LSN	Logical Sector Number
MSB	Most Significant Byte
msb	Most Significant Bit
NA	Numerical Aperture
NRZ	Non Return to Zero
NRZI	Non Return to Zero Inverted
NSL	Normalized Slicing Level
OPC	Optimum Power Control
OTP	Opposite Track Path
PAA	Physical Address in ADIP
PBS	Polarizing Beam Splitter
PI	Parity of Inner-code
PLL	Phase Locked Loop
PO	Parity of Outer-code
PP	Push-Pull
pp	peak-to-peak
PSN	Physical Sector Number
PTP	Parallel Track Path
RIN	Relative Intensity Noise
RPM	Revolutions per Minute
RS	Reed-Solomon code
RSV	Reserved (in use by specific applications)
RUN	Recording UNit
SNR	Signal to Noise Ration
SPS	Start Position Shift
SYNC	Synchronization code

7 General description of the optical disk

The optical disk that is the subject of this Ecma Standard consists of two substrates bonded together by an adhesive layer, so that the recording layer(s) is (are) on the inside. The centring of the disk is performed on the edge of the centre hole of the assembled disk on the side currently accessed. Clamping is performed in the Clamping Zone. This Ecma Standard provides for two Types of such disks.

Type S5 consists of a substrate, a single recording layer and a dummy substrate. The recording layer can be accessed from one side only. The capacity is 4,7 Gbytes for the 120 mm sized disk and 1,46 Gbytes for the 80 mm sized disk.

Type D10 consists of two substrates and two recording layers. From each side of the disk only one of the recording layers can be accessed. The capacity is 9,4 Gbytes for the 120 mm sized disk and 2,92 Gbytes for the 80 mm sized disk.

Data can be written onto the disk as marks in the form of amorphous spots in the crystalline recording layer and can be overwritten with a focused optical beam, using the phase change effect between amorphous and crystalline states. The data can be read with a focused optical beam, using the phase change effect as the difference in the reflectivity between amorphous and crystalline states. The beam accesses the recording layer through a transparent substrate of the disk.

Figure 1 shows schematically the two Types.

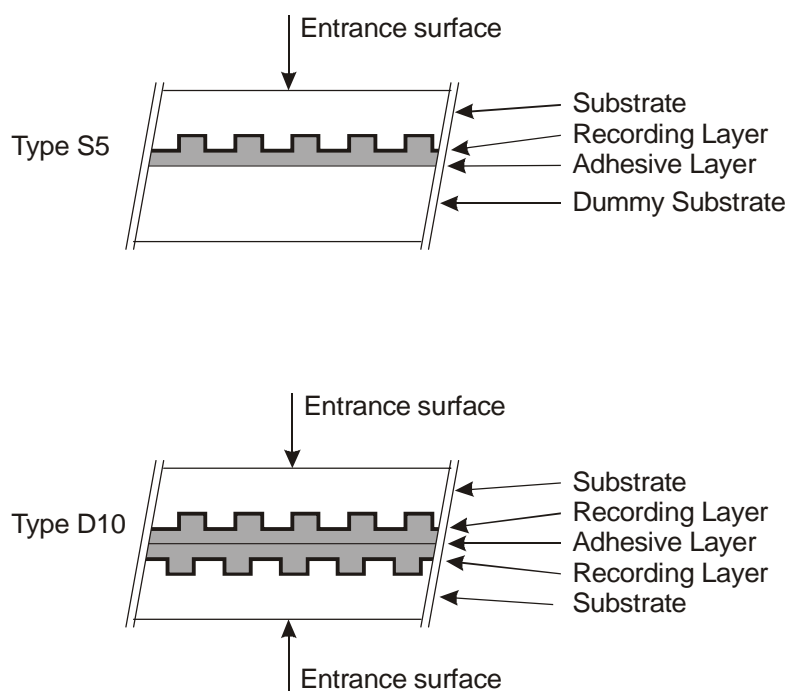

Figure 1 - Types of +RW disk

8 General Requirements

8.1 Environments

8.1.1 Test environment

In the test environment, the air immediately surrounding the disk shall have the following properties:

temperature	: 23 °C ± 2 °C
relative humidity	: 45 % to 55 %
atmospheric pressure	: 60 kPa to 106 kPa

No condensation on the disk shall occur. Before testing, the disk shall be conditioned in this environment for 48 h minimum. It is recommended that, before testing, the entrance surface of the disk shall be cleaned according to the instructions of the manufacturer of the disk.

Unless otherwise stated, all tests and measurements shall be made in this test environment.

8.1.2 Operating environment

This Ecma Standard requires that a disk which meets all requirements of this Ecma Standard in the specified test environment shall provide data interchange over the specified ranges of environmental parameters in the operating environment.

The operating environment is the environment where the air immediately surrounding the disk shall have the following properties:

temperature	: 5 °C to 55 °C
relative humidity	: 3 % to 85 %
absolute humidity	: 1 g/m ³ to 30 g/m ³
atmospheric pressure	: 60 kPa to 106 kPa
temperature gradient	: 10 °C/h max.
relative humidity gradient	: 10 %/h max.

No condensation on the disk shall occur. If the disk has been exposed to conditions outside those specified in this Clause, it shall be acclimatized in an allowed operating environment for at least 2 h before use.

8.1.3 Storage environment

The storage environment is defined as the environment where the air immediately surrounding the disk shall have the following properties:

temperature	: -10 °C to 55 °C
relative humidity	: 3 % to 90 %
absolute humidity	: 1 g/m ³ to 30 g/m ³
atmospheric pressure	: 60 kPa to 106 kPa
temperature gradient	: 15 °C/h max.
relative humidity gradient	: 10 %/h max.

No condensation on the disk shall occur.

8.1.4 Transportation

This Ecma Standard does not specify requirements for transportation; guidance is given in Annex L.

8.2 Safety requirements

The disk shall satisfy the safety requirements of Standard ECMA-287, when used in the intended manner or in any foreseeable use in an information processing system.

8.3 Flammability

The disk and its components shall be made from materials that comply with the flammability class for HB materials, or better, as specified in Standard ECMA-287.

9 Reference Drive

The Reference Drive shall be used for the measurement of optical parameters for conformance with the requirements of this Ecma Standard. The critical components of this device have the characteristics specified in this Clause.

9.1 Optical system

The basic set-up of the optical system of the Reference Drive used for measuring the (over)write and read parameters is shown in Figure 2. Different components and locations of components are permitted, provided that the performance remains the same as that of the set-up in Figure 2. The optical system shall be such that the detected light reflected from the entrance surface of the disk is minimized so as not to influence the accuracy of the measurements.

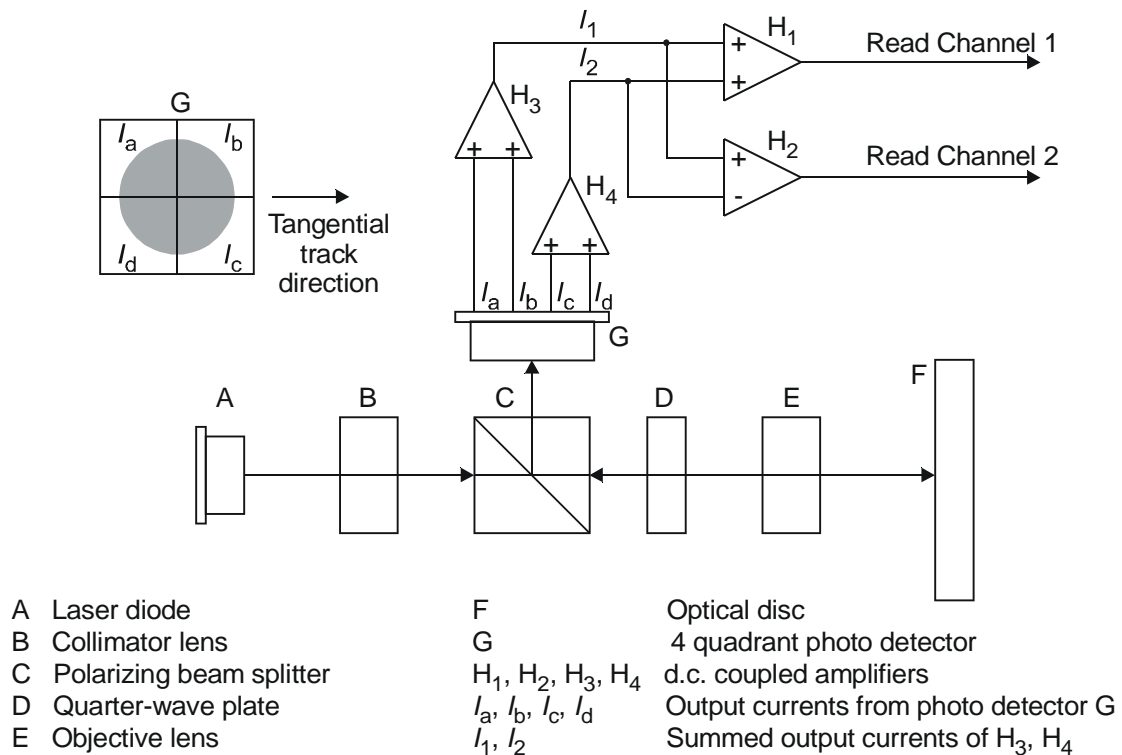

Figure 2 - Optical system of the Reference Drive

The combination of a polarizing beam splitter C and a quarter-wave plate D shall separate the entrance optical beam from the laser diode A and the reflected optical beam from the disk F. The beam splitter C shall have a p-s intensity reflectance ratio of at least 100.

9.2 Optical beam

The focused optical beam used for writing and reading data shall have the following properties:

- | | |
|--|---|
| a) Wavelength (λ) | 655nm ^{+10nm}
-5nm |
| b) Numerical aperture of the objective lens (NA) | 0,65 ± 0,01 |
| c) The objective lens shall be compensated for spherical aberrations caused by a parallel substrate with nominal thickness (0,6 mm) and nominal refractive index (1,55). | |
| d) Wave front aberration | 0,033 × λ rms max. |
| e) Light intensity at the rim of the pupil of the objective lens | 35 % to 50 % of the maximum intensity in the radial direction and 45 % to 60 % in the tangential direction. |
| f) Polarization of the light | Circular |
| g) Read power (average) | 0,7 mW ± 0,1 mW
(d.c. or HF modulated with a frequency >400 MHz) |
| h) Write power and pulse width | see Annex G |
| i) Relative Intensity Noise (RIN)* of the laser diode | -134 dB/Hz max. |

*RIN (dB/Hz) = 10 log [(a.c. light power density / Hz) / d.c. light power]

9.3 Read channel 1

Read channel 1 shall be provided to generate signals from the marks and spaces in the recording layer. This Read channel shall be used for reading the user-written information, using the change in reflectivity of the marks and spaces due to the phase change effect. The read amplifiers after the photo detectors in the Read channel shall have a flat response within 1 dB from d.c. to 20 MHz.

For measurement of jitter, the characteristics of the PLL and the slicer, etc. are specified in Annex E.

9.4 Disk clamping

For measuring, the disk shall be clamped between two concentric rings covering most of the Clamping Zone (see 10.5). The top clamping area shall have the same diameters as the bottom clamping area (Figure 3).

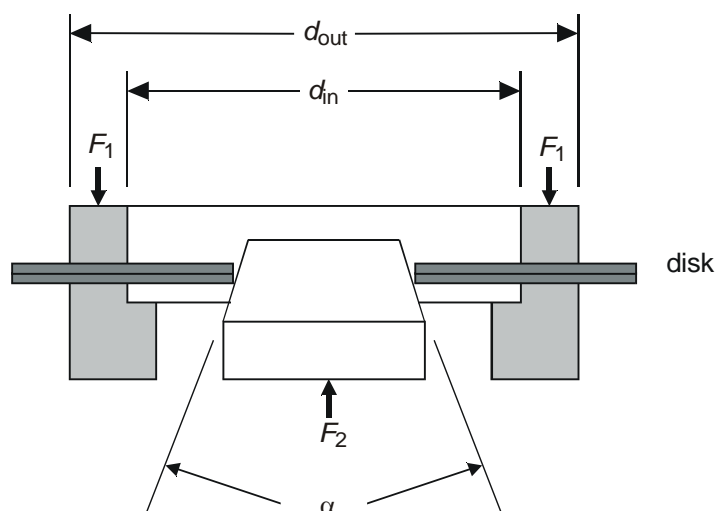

Figure 3 - Clamping and chucking conditions

Clamping shall occur between

$$d_{in} = 22,3 \text{ mm} \begin{matrix} +0,5\text{mm} \\ -0,0\text{mm} \end{matrix} \quad \text{and} \quad d_{out} = 32,7 \text{ mm} \begin{matrix} +0,0\text{mm} \\ -0,5\text{mm} \end{matrix}$$

The total clamping force shall be $F_1 = 2,0 \text{ N} \pm 0,5 \text{ N}$. In order to prevent warping of the disk under the moment of force generated by the clamping force and the chucking force F_2 exerted on the rim of the centre hole of the disk, F_2 shall not exceed 0,5 N (see Figure 3).

The tapered cone angle, α , shall be $40,0^\circ \pm 0,5^\circ$.

9.5 Rotation of the disk

The actual rotation speed for reading the disk shall be such that it results in the Reference velocity of $3,49 \text{ m/s} \pm 0,03 \text{ m/s}$ at the nominal Channel bit rate of 26,156 25 Mbit/s. The direction of rotation shall be counter-clockwise when viewed from the objective lens.

The actual rotation speed (v_{actual}) for writing the disk shall be such that it includes all velocities for which parameters are specified in the Physical format information in the ADIP Aux Frames in the Lead-in Zone of the disk (see 14.4.1.1 and 14.4.2).

NOTE

The rotational speed of the disk is depending on the radial position: $\text{angular velocity} = 60 \times \frac{v_{\text{actual}}}{2\pi \times r} \text{ RPM}$

When testing the disk the actual speed is limited such that the angular velocity does not exceed 10 000 RPM.

9.6 Wobble channel (Read channel 2)

Read channel 2 of the drive provides the wobble signals to control the access to addressed locations on the disk during writing. The wobble signal is generated in Read Channel 2 as a signal ($I_1 - I_2$) related to the difference in the amount of light in the two halves of the exit pupil of the objective lens. The read amplifiers after the photo detectors in the Read channel shall have a flat response within 1 dB from d.c. to 20 MHz.

9.7 Tracking channel (Read channel 2)

Read channel 2 of the drive provides the tracking error signals to control the servos for radial tracking of the optical beam. The radial tracking error is generated in Read Channel 2 as a signal ($I_1 - I_2$) related to the difference in the amount of light in the two halves of the exit pupil of the objective lens.

The method of generating the axial tracking error is not specified for the Reference Drive.

9.8 Reference servo systems

9.8.1 Normalized servo transfer function

The open-loop transfer function, $H_s(i\omega)$ for the axial and radial tracking servos is given by equation (1),

$$H_s(i\omega) = \frac{1}{3} \times \left(\frac{\omega_0}{i\omega} \right)^2 \times \frac{1 + \frac{3i\omega}{\omega_0}}{1 + \frac{i\omega}{3\omega_0}} \quad (1)$$

where: $i = \sqrt{-1}$, $\omega = 2\pi f$ and $\omega_0 = 2\pi f_0$

and f_0 is the 0 dB crossover frequency of the open-loop transfer function.

The crossover frequencies of the lead-lag network of the servo are

lead break frequency: $f_1 = f_0 / 3$

lag break frequency: $f_2 = f_0 \times 3$

Another frequency of importance is the frequency f_x at which a sinusoidal displacement with an amplitude equal to the maximum allowed residual tracking error e_{\max} , corresponds to the maximum expected acceleration α_{\max} . This frequency can be calculated as follows:

$$f_x = \frac{1}{2\pi} \sqrt{\frac{\alpha_{\max}}{e_{\max}}}$$

Because the tracking error signals from the disk can have rather large variations, the tracking error signal fed into each reference servo loop shall be adjusted to a fixed level (effectively calibrating the total loop gain), such to guarantee the specified bandwidth.

9.8.2 Reference Servo for Axial Tracking

The crossover frequency of the normalized servo transfer function (H_s) for axial tracking, $f_0 = \omega_0 / (2\pi)$ shall be given by equation (2), where α_{\max} is the maximum expected axial acceleration of $8,0 \text{ m/s}^2$, which is multiplied by a factor $m = 1,5$ for servo margin. The tracking error e_{\max} , caused by this $m \times \alpha_{\max}$, shall be $0,20 \text{ } \mu\text{m}$.

Thus the crossover frequency f_0 shall be given by

$$f_0 = \frac{1}{2\pi} \sqrt{\frac{3 \times m \times \alpha_{\max}}{e_{\max}}} = \frac{1}{2\pi} \sqrt{\frac{3 \times 1,5 \times 8}{0,20 \times 10^{-6}}} = 2,1 \text{ kHz} \quad (2)$$

For an open loop transfer function H of the Reference Servo for axial tracking, $|1+H|$ is limited as schematically shown by the shaded region of Figure 4.

Bandwidth from 100 Hz to 10 kHz

$|1+H|$ shall be within 20 % of $|1+H_s|$.

Bandwidth from 26 Hz to 100 Hz

$|1+H|$ shall be within the limits enclosed by the following four points.

- 1) 41,7 dB at 100 Hz ($|1+H_s|$ at 100 Hz - 20 %)
- 2) 45,2 dB at 100 Hz ($|1+H_s|$ at 100 Hz + 20 %)
- 3) 65,1 dB at 26 Hz ($|1+H_s|$ at 26 Hz - 20 %)
- 4) 85,1 dB at 26 Hz ($|1+H_s|$ at 26 Hz - 20 % + 20 dB)

Bandwidth from 9,5 Hz to 26 Hz

$|1+H|$ shall be between 65,1 dB and 85,1 dB.

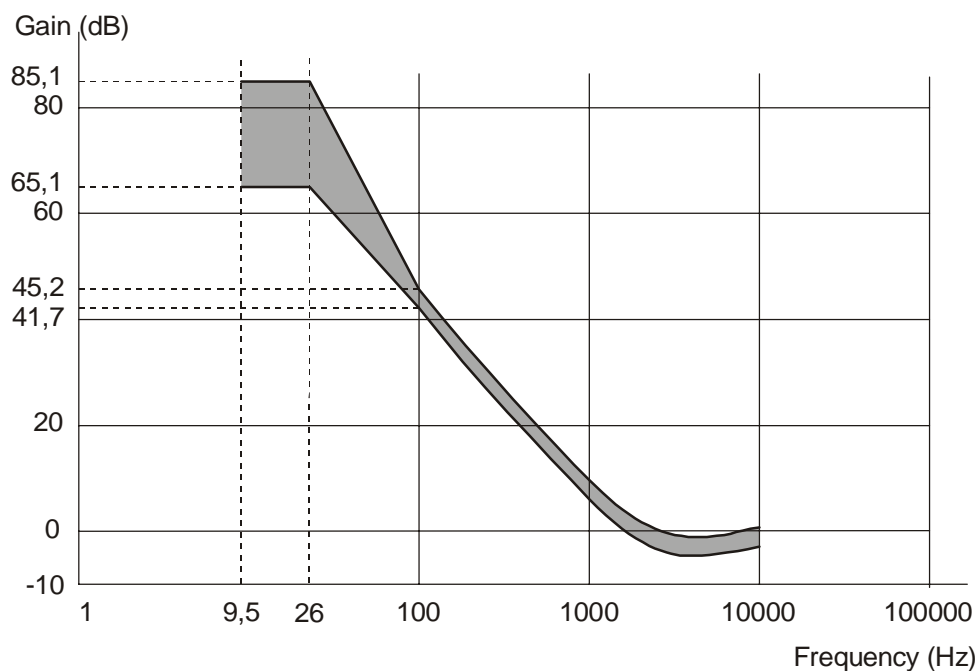

Figure 4 - Reference servo for axial tracking

9.8.3 Reference Servo for Radial Tracking

The crossover frequency of the normalized servo transfer function (H_s) for radial tracking, $f_0 = \omega_0 / (2\pi)$ shall be given by equation (3), where α_{\max} is the maximum expected radial acceleration of $1,1 \text{ m/s}^2$, which is multiplied by a factor $m = 1,5$ for servo margin. The tracking error e_{\max} , caused by this $m \times \alpha_{\max}$, shall be $0,022 \text{ } \mu\text{m}$.

Thus the crossover frequency f_0 shall be given by

$$f_0 = \frac{1}{2\pi} \sqrt{\frac{3 \times m \times \alpha_{\max}}{e_{\max}}} = \frac{1}{2\pi} \sqrt{\frac{3 \times 1,5 \times 1,1}{0,022 \times 10^{-6}}} = 2,4 \text{ kHz} \quad (3)$$

For an open loop transfer function H of the Reference Servo for radial tracking, $|1+H|$ is limited as schematically shown by the shaded region of Figure 5.

Bandwidth from 100 Hz to 10 kHz

$|1+H|$ shall be within 20 % of $|1+H_s|$.

Bandwidth from 28,2 Hz to 100 Hz

$|1+H|$ shall be within the limits enclosed by the following four points.

- 1) 43,7 dB at 100 Hz ($|1+H_s|$ at 100 Hz – 20 %)
- 2) 47,2 dB at 100 Hz ($|1+H_s|$ at 100 Hz + 20 %)
- 3) 65,6 dB at 28,2 Hz ($|1+H_s|$ at 28,2 Hz – 20 %)
- 4) 85,6 dB at 28,2 Hz ($|1+H_s|$ at 28,2 Hz – 20 % + 20 dB)

Bandwidth from 9,5 Hz to 28,2 Hz

$|1+H|$ shall be between 65,6 dB and 85,6 dB.

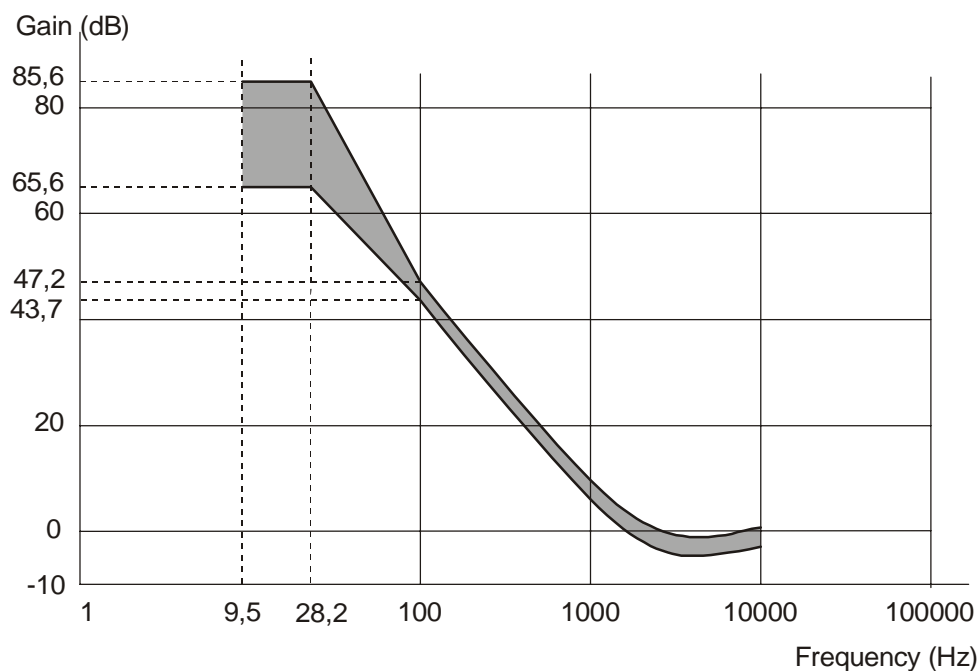

Figure 5 - Reference servo for radial tracking

Section 2 - Dimensional, mechanical and physical characteristics of the disk

10 Dimensional characteristics

Dimensional characteristics are specified for those parameters deemed mandatory for interchange and compatible use of the disk. Where there is freedom of design, only the functional characteristics of the elements described are indicated. The enclosed drawing, Figure 6 shows the dimensional requirements in summarized form. The different parts of the disk are described from the centre hole to the outside rim.

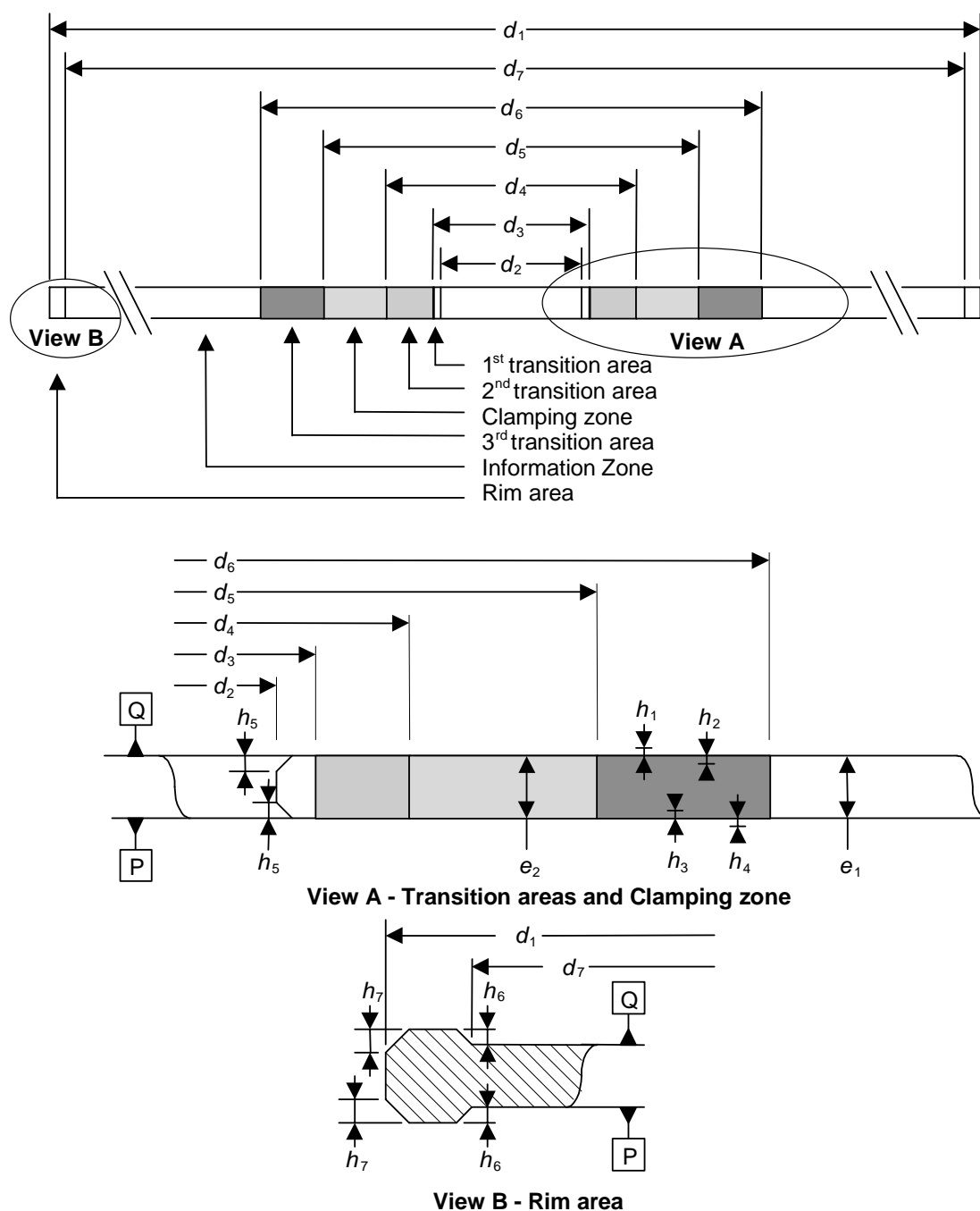

Figure 6 - Physical disk dimensions

10.1 Reference Planes

The dimensions are referred to two Reference Planes P and Q.

Reference Plane P is the primary Reference Plane. It is the plane on which the bottom surface of the Clamping Zone rests (see 10.5).

Reference Plane Q is the plane parallel to Reference Plane P at the height of the top surface of the Clamping Zone (see Figure 6).

10.2 Overall dimensions

The disk shall have an overall diameter (see also Annex A)

$$d_1 = 120,00 \text{ mm} \pm 0,30 \text{ mm}$$

The centre hole of a substrate or a dummy substrate shall have a diameter (see Figure 7)

$$d_{\text{substrate}} = 15,00 \text{ mm} \begin{matrix} +0,15\text{mm} \\ -0,00\text{mm} \end{matrix}$$

The hole of an assembled disk, i.e. with both parts bonded together, shall have a diameter

$$d_2 = 15,00 \text{ mm min.}$$

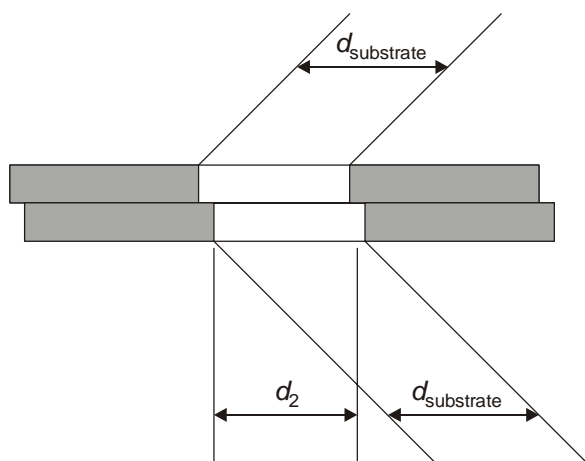

Figure 7 - Hole diameters for an assembled disk

The corners of the centre hole shall be free of any burrs or sharp features and shall be rounded off or chamfered by

$$h_5 = 0,1 \text{ mm max.}$$

The thickness of the disk shall be

$$e_1 = 1,20 \text{ mm} \begin{matrix} +0,30\text{mm} \\ -0,06\text{mm} \end{matrix}$$

10.3 First transition area

In the area defined by d_2 and

$$d_3 = 16,0 \text{ mm min.}$$

the surface of the disk is permitted to be above Reference Plane P and/or below Reference Plane Q by 0,10 mm max.

10.4 Second transition area

This area shall extend between diameter d_3 and diameter

$$d_4 = 22,0 \text{ mm max.}$$

In this area the disk may have an uneven surface or burrs up to 0,05 mm max. beyond Reference Planes P and/or Q.

10.5 Clamping Zone

This Zone shall extend between diameter d_4 and diameter

$$d_5 = 33,0 \text{ mm min.}$$

Each side of the Clamping Zone shall be flat within 0,1 mm. The top side of the Clamping Zone, i.e. that of Reference Plane Q shall be parallel to the bottom side, i.e. that of Reference Plane P within 0,1 mm.

In the Clamping Zone the thickness e_2 of the disk shall be

$$e_2 = 1,20 \text{ mm } \begin{matrix} +0,20\text{mm} \\ -0,10\text{mm} \end{matrix}$$

10.6 Third transition area

This area shall extend between diameter d_5 and diameter

$$d_6 = 44,0 \text{ mm max.}$$

In this area the top surface is permitted to be above Reference Plane Q by

$$h_1 = 0,25 \text{ mm max.}$$

or below Reference Plane Q by

$$h_2 = 0,10 \text{ mm max.}$$

The bottom surface is permitted to be above Reference Plane P by

$$h_3 = 0,10 \text{ mm max.}$$

or below Reference Plane P by

$$h_4 = 0,25 \text{ mm max.}$$

10.7 Information Zone

The Information Zone shall extend from diameter d_6 to diameter

$$d_7 = 117,5 \text{ mm min. (see also Annex A)}$$

This Zone consists of the Lead-in Zone, the Data Zone, and the Lead-out Zone.

10.8 Rim area

The rim area is that area extending from diameter d_7 to diameter d_1 . In this area the surfaces are permitted to both extend beyond Reference Plane Q or Reference Plane P

$$h_6 = 0,1 \text{ mm max.}$$

The outer corners of the disk shall be free of any burrs or sharp features and shall be rounded off or chamfered by

$$h_7 = 0,2 \text{ mm max.}$$

10.9 Remark on tolerances

All heights specified in the preceding clauses and indicated by h_i are independent from each other. This means that, for example, if the top surface of the third transition area is below Reference Plane Q by up to h_2 , there is no implication that the bottom surface of this area has to be above Reference Plane P by up to h_3 . Where dimensions have the same - generally maximum - numerical value, this does not imply that the actual values have to be identical.

11 Mechanical characteristics

11.1 Mass

The mass of the disk shall be in the range of 13,0 g to 20,0 g (see also Annex A).

11.2 Moment of inertia

The moment of inertia of the disk, relative to its rotation axis, shall not exceed 0,040 g·m² (see also Annex A).

11.3 Dynamic imbalance

The dynamic imbalance of the disk, relative to its rotation axis, shall not exceed 2,5 g·mm (see also Annex A).

11.4 Axial runout

When measured by the optical system with the Reference Servo for axial tracking, the disk rotating at the Reference velocity of 3,49 m/s (see 9.5), the deviation of the recording layer from its nominal position in the direction normal to the Reference Planes shall not exceed 0,30 mm.

The residual tracking error below 10 kHz, measured using the Reference Servo for axial tracking, shall not exceed 0,13 μm (displacement of the objective lens needed to move the focal point of the optical beam onto the recording layer).

The measuring filter shall be a Butterworth LPF,

f_c (-3 dB): 10 kHz, with slope: -80 dB/decade.

11.5 Radial runout

The runout of the outer edge of the disk shall not exceed 0,30 mm peak-to-peak.

The radial runout of tracks shall not exceed 70 μm peak-to-peak.

The residual tracking error below 1,1 kHz ($= f_\chi$ as defined in 9.8.1), measured using the Reference Servo for radial tracking and the disk rotating at the Reference velocity of 3,49 m/s (see 9.5), shall not exceed 0,015 μm.

The measuring filter shall be a Butterworth LPF,

f_c (-3 dB): 1,1 kHz, with slope: -80 dB/decade.

The rms noise value of the residual error signal in the frequency band from 1,1 kHz to 10 kHz, measured with an integration time of 20 ms, using the Reference Servo for radial tracking, shall not exceed 0,016 μm.

The measuring filter shall be a Butterworth BPF,

frequency range (-3 dB) : 1,1 kHz, with slope: +80 dB/decade
to : 10 kHz, with slope: -80 dB/decade.

12 Optical characteristics in the Information Zone

12.1 Index of refraction

The index of refraction of the substrate in the Information Zone shall be $1,55 \pm 0,10$.

12.2 Thickness of the substrate

The thickness of the substrate, from the entrance surface to the recording layer, varies with the index of refraction of the substrate and shall be defined as the enclosed region in Figure 8.

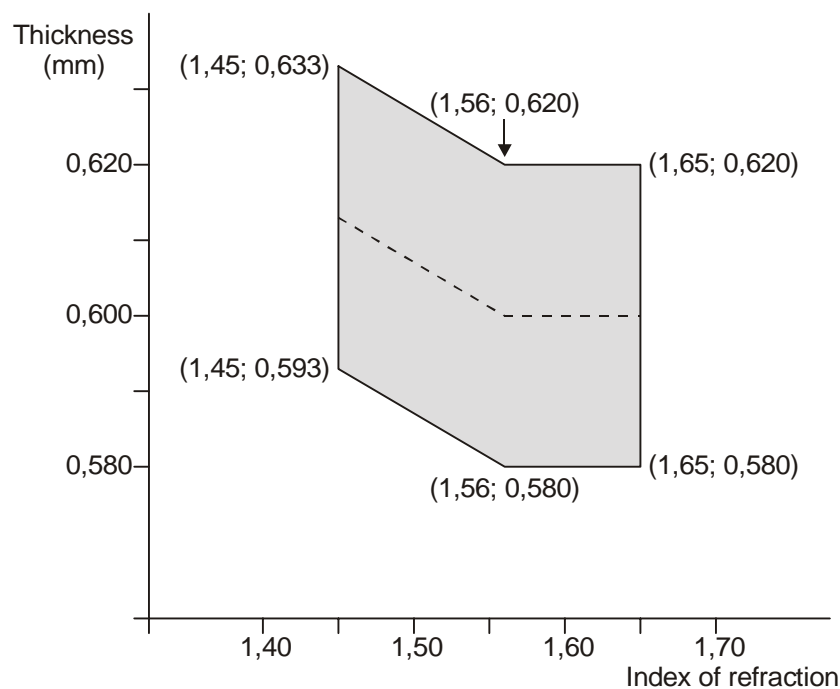

Figure 8 - Thickness of the substrate

12.3 Reflectivity

The double-pass optical transmission of the substrate and the reflectivity of the recording layer are measured together as the reflectance R of the disk. When measured according to Annex C the value of R shall be

in the Information Zone $0,18 \leq R_d \leq 0,30$ in the unrecorded groove
 $0,18 \leq R_{14H} \leq 0,30$ in the recorded groove

12.4 Birefringence

The birefringence of the substrate shall not exceed 60 nm when measured according to Annex D.

12.5 Angular deviation

The angular deviation is the angle α between a parallel incident beam perpendicular to the Reference Plane P and the reflected beam (see Figure 9). The incident beam shall have a diameter in the range 0,30 mm to 3,0 mm. This angle α includes deflection due to the entrance surface and to the unparallelism of the recording layer with the entrance surface.

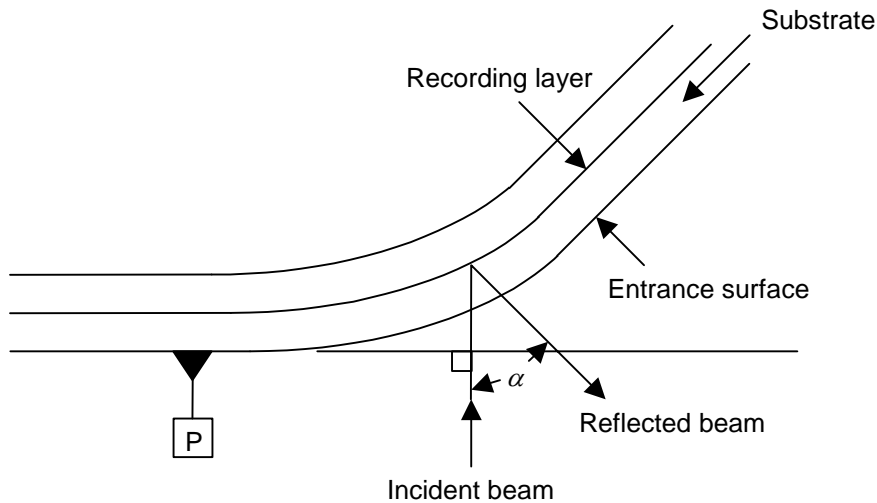

Figure 9 - Angular deviation

The angular deviation shall be

In radial direction: $|\alpha| = 0,70^\circ \text{ max.}$

The variation of α in radial direction over one revolution shall be $0,80^\circ \text{ peak-to-peak max.}$

In tangential direction: $|\alpha| = 0,30^\circ \text{ max.}$

Section 3 - Format of information

13 Data format

The data received from the host, called Main Data, is formatted in a number of steps before being recorded on the disk.

It is transformed successively into

- a Data Frame,
- a Scrambled Frame,
- an ECC Block,
- 16 Recording Frames,
- 16 Physical Sectors,
- a Recording Unit.

These steps are specified in the following clauses.

13.1 Data Frames

A Data Frame shall consist of 2 064 bytes arranged in an array of 12 rows each containing 172 bytes (Figure 10). The first row shall start with three fields, called Identification Data (ID), ID Error Detection Code (IED), and RSV bytes, followed by 160 Main Data bytes. The next 10 rows shall each contain 172 Main Data bytes, and the last row shall contain 168 Main Data bytes followed by four bytes for recording an Error Detection Code (EDC). The 2 048 Main Data bytes are identified as D_0 to $D_{2\ 047}$.

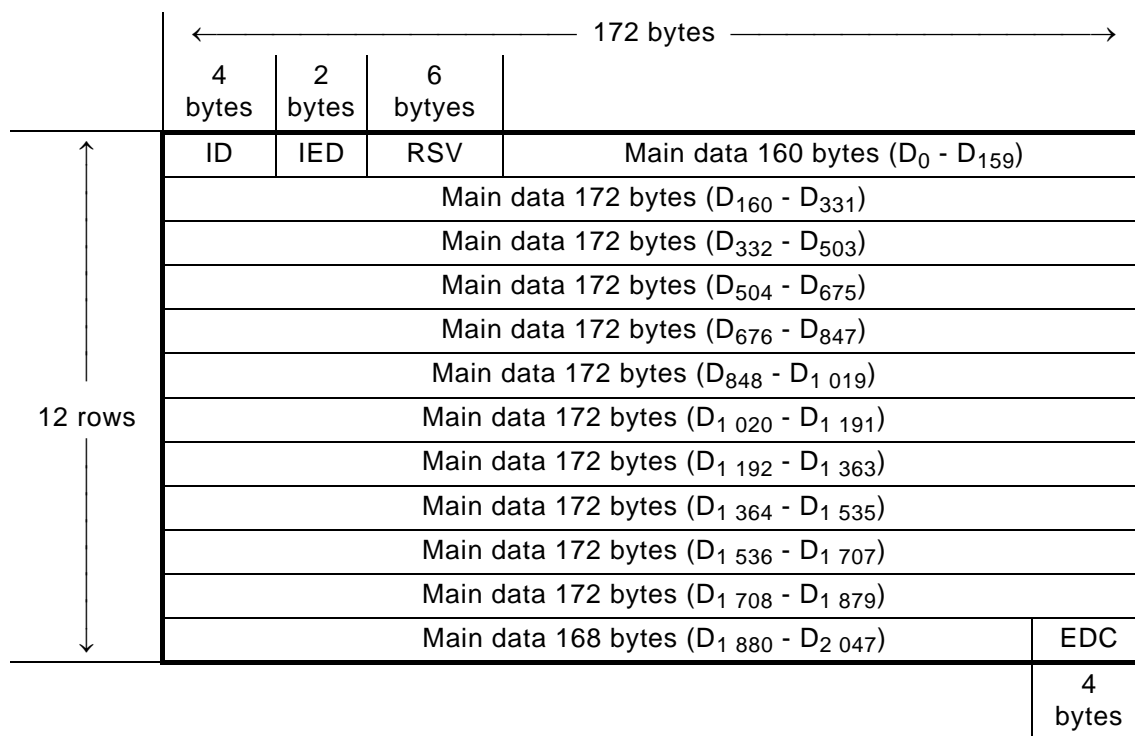

Figure 10 - Data Frame

13.1.1 Identification Data (ID)

This field shall consist of four bytes, the bits of which are numbered consecutively from b_0 (lsb) to b_{31} (msb), see Figure 11.

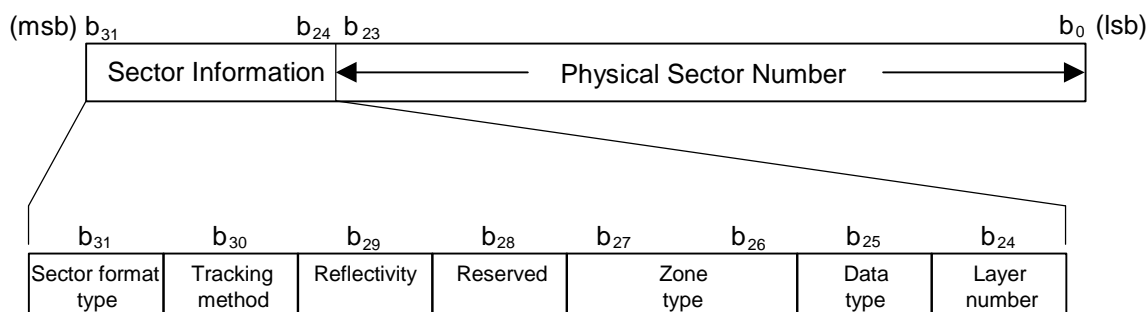

Figure 11 - Identification Data (ID)

The bits of the most significant byte, the Sector Information, shall be set as follows:

- Bit b_{31} shall be set to ZERO, indicating a CLD format
- Bit b_{30} shall be set to ONE, indicating groove tracking (see Clause 14)
- Bit b_{29} shall be set to ONE indicating that the reflectance does not exceed 40 %
- Bit b_{28} shall be set to ZERO
- Bits b_{27} to b_{26} shall be set to
 ZERO ZERO in the Data Zone
 ZERO ONE in the Lead-in Zone
 ONE ZERO in the Lead-out Zone
- Bit b_{25} shall be set to ONE, indicating Rewritable data
- Bit b_{24} shall be set to ZERO, indicating that through an entrance surface only one recording layer can be accessed.

The least significant three bytes, bits b_{23} to b_0 , shall specify the Physical Sector Number in binary notation. The Physical Sector Number of the first Physical Sector of an ECC Block shall be an integer multiple of 16.

13.1.2 ID Error Detection Code (IED)

When identifying all bytes of the array shown in Figure 10 as $C_{i,j}$ for $i = 0$ to 11 and $j = 0$ to 171, the bytes of IED are represented by $C_{0,j}$ for $j = 4$ to 5. Their setting is obtained as follows.

$$\text{IED}(x) = \sum_{j=4}^5 C_{0,j} x^{5-j} = l(x) x^2 \text{ mod } G_E(x)$$

where

$$l(x) = \sum_{j=0}^3 C_{0,j} x^{3-j} \quad \text{and} \quad G_E(x) = (x + 1)(x + \alpha)$$

α is the primitive root of the primitive polynomial $P(x) = x^8 + x^4 + x^3 + x^2 + 1$

13.1.3 RSV

This field shall consist of 6 bytes. The first byte may be set by the application. If not specified by the application, it is reserved and shall be set to (00). The remaining 5 bytes are reserved and shall all be set to (00).

Under no circumstance may other data received from the host be recorded in this field.

Circumvention: *Recorders and recording drives shall be considered as circumvention devices when these are produced to record, or can easily be modified to record, in any manner, a user-defined number in this field.*

13.1.4 Error Detection Code (EDC)

This 4-byte field shall contain the parities of an Error Detection Code computed over the preceding 2 060 bytes of the Data Frame. Considering the Data Frame as a single bit field starting with the most significant bit of the first byte of the ID field and ending with the least significant bit of the EDC field, then this msb will be $b_{16\ 511}$ and the lsb will be b_0 . Each bit b_i of the EDC is shown as follows for $i = 0$ to 31:

$$\text{EDC}(x) = \sum_{i=0}^{31} b_i x^i = l(x) \bmod G(x)$$

where

$$l(x) = \sum_{i=32}^{16\ 511} b_i x^i \quad \text{and} \quad G(x) = x^{32} + x^{31} + x^4 + 1$$

13.2 Scrambled Frames

The 2 048 Main Data bytes shall be scrambled by means of the circuit shown in Figure 12 which shall consist of a feedback bit shift register in which bits r_7 (msb) to r_0 (lsb) represent a scrambling byte at each 8-bit shift.

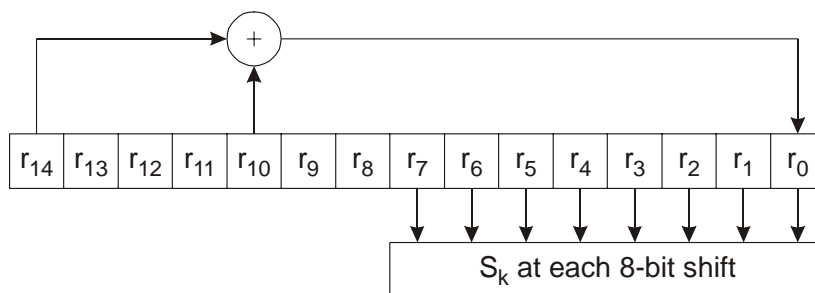

Figure 12 - Feedback shift register

At the beginning of the scrambling procedure of a Data Frame, positions r_{14} to r_0 shall be pre-set to the value(s) specified in Table 1 (the msb of the pre-set value shall be discarded). The same pre-set value shall be used for 16 consecutive Data Frames. After 16 groups of 16 Data Frames, the sequence is repeated. The initial pre-set number is equal to the value represented by bits b_7 (msb) to b_4 (lsb) of the ID field of the Data Frame. Table 1 specifies the initial pre-set value of the shift register corresponding to the 16 initial pre-set numbers.

Table 1 - Initial values of the shift register

Initial pre-set number	Initial pre-set value	Initial pre-set number	Initial pre-set value
(0)	(0001)	(8)	(0010)
(1)	(5500)	(9)	(5000)
(2)	(0002)	(A)	(0020)
(3)	(2A00)	(B)	(2001)
(4)	(0004)	(C)	(0040)
(5)	(5400)	(D)	(4002)
(6)	(0008)	(E)	(0080)
(7)	(2800)	(F)	(0005)

The part of the initial value of r_7 to r_0 is taken out as scrambling byte S_0 . After that, an 8-bit shift is repeated 2 047 times and the following 2 047 bytes shall be taken from r_7 to r_0 as scrambling bytes S_1 to $S_{2\ 047}$. The Main Data bytes D_k of the Data Frame become scrambled bytes D'_k where $D'_k = D_k \oplus S_k$ for $k = 0$ to 2 047 (\oplus stands for Exclusive OR)

13.3 ECC Blocks

An ECC Block is formed by arranging 16 consecutive Scrambled Frames in an array of 192 rows of 172 bytes each (Figure 13). To each of the 172 columns 16 bytes of Parity of Outer Code are added, then, to each of the resulting 208 rows, 10 bytes of Parity of Inner Code are added. Thus a complete ECC Block comprises 208 rows of 182 bytes each. The bytes of this array are identified as $B_{i,j}$ as follows, where i is the row number and j is the column number.

$B_{i,j}$ for $i = 0$ to 191 and $j = 0$ to 171 are bytes from the Scrambled Frames

$B_{i,j}$ for $i = 192$ to 207 and $j = 0$ to 171 are bytes of the Parity of Outer Code

$B_{i,j}$ for $i = 0$ to 207 and $j = 172$ to 181 are bytes of the Parity of Inner Code

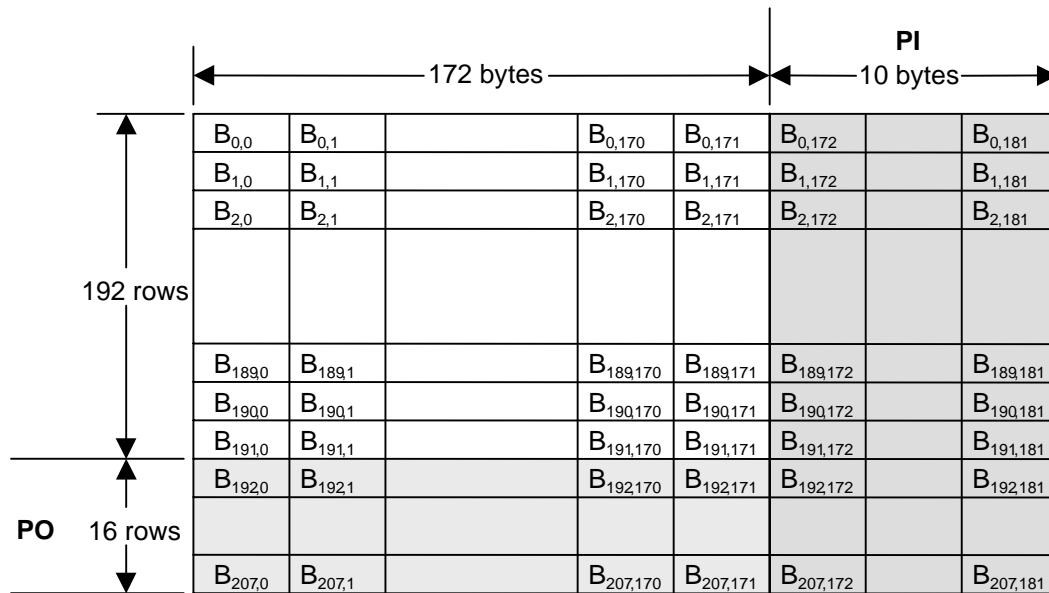

Figure 13 - ECC Block

The PO and PI bytes shall be obtained as follows.

In each of columns $j = 0$ to 171, the 16 PO bytes are defined by the remainder polynomial $R_j(x)$ to form the outer code RS (208,192,17).

$$R_j(x) = \sum_{i=192}^{207} B_{i,j} x^{207-i} = I_j(x) x^{16} \text{ mod } G_{PO}(x)$$

where

$$I_j(x) = \sum_{i=0}^{191} B_{i,j} x^{191-i} \quad \text{and} \quad G_{PO}(x) = \prod_{k=0}^{15} (x + \alpha^k)$$

In each of rows $i = 0$ to 207, the 10 PI bytes are defined by the remainder polynomial $R_i(x)$ to form the inner code RS(182,172,11).

$$R_i(x) = \sum_{j=172}^{181} B_{i,j} x^{181-j} = I_i(x) x^{10} \text{ mod } G_{PI}(x)$$

where

$$I_i(x) = \sum_{j=0}^{171} B_{i,j} x^{171-j} \quad \text{and} \quad G_{PI}(x) = \prod_{k=0}^9 (x + \alpha^k)$$

α is the primitive root of the primitive polynomial $P(x) = x^8 + x^4 + x^3 + x^2 + 1$

13.4 Recording Frames

Sixteen Recording Frames shall be obtained by interleaving one of the 16 PO rows at a time after every 12 rows of an ECC Block (Figure 14). This is achieved by re-locating the bytes $B_{i,j}$ of the ECC Block as $B_{m,n}$ for

$$m = i + \text{int} [i / 12] \quad \text{and} \quad n = j \quad \text{for} \quad i \leq 191$$

$$m = 13 \times (i - 191) - 1 \quad \text{and} \quad n = j \quad \text{for} \quad i \geq 192$$

where $\text{int} [x]$ represents the largest integer not greater than x .

Thus the 37 856 bytes of an ECC Block are re-arranged into 16 Recording Frames of 2 366 bytes. Each Recording Frame consists of an array of 13 rows of 182 bytes.

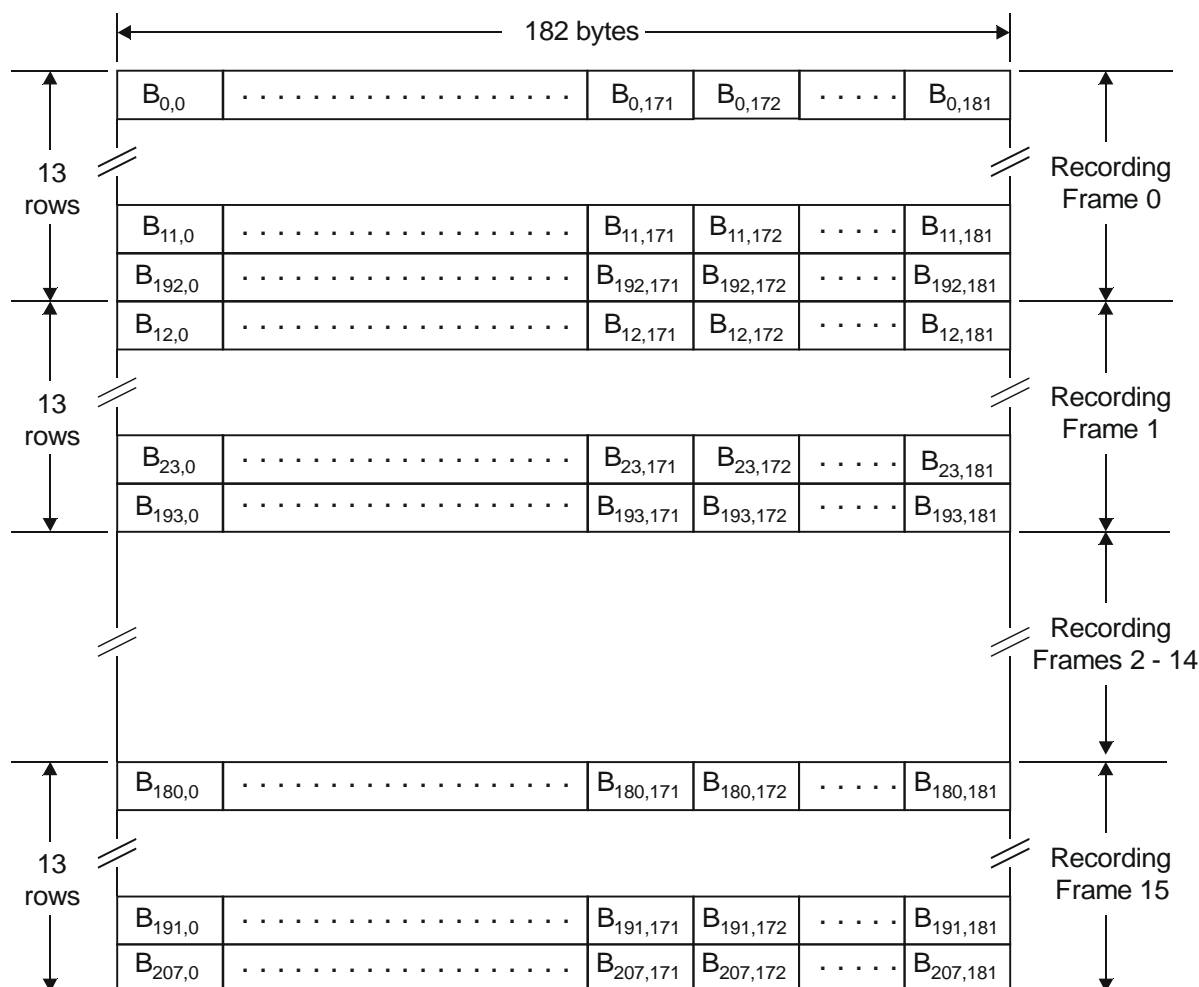

Figure 14 - Recording Frames obtained from an ECC Block

13.5 Modulation and NRZI conversion

The 8-bit bytes of each Recording Frame shall be transformed into 16-bit Code Words with the run length limitation that between 2 ONES there shall be at least 2 ZEROS and at most 10 ZEROS (RLL(2,10)). Annex H specifies the conversion tables to be applied. The Main Conversion table and the Substitution table specify a 16-bit Code Word for each 256 8-bit bytes with one of 4 States. For each 8-bit byte, the tables indicate the corresponding Code Word, as well as the State for the next 8-bit byte to be encoded.

The 16-bit Code Words shall be NRZI-converted into Channel bits before recording on the disk (see Figure 15). The Channel clock period is the time between 2 consecutive Channel bits.

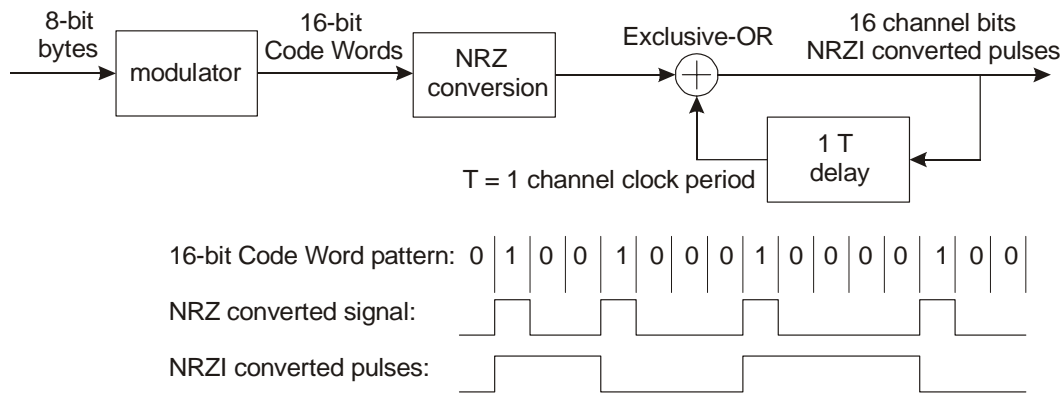

Figure 15 - NRZI conversion

13.6 Physical Sectors

The structure of a Physical Sector is shown in Figure 16. It shall consist of 13 rows, each comprising two Sync Frames. A Sync Frame shall consist of a SYNC Code from Table 2 and 1 456 Channel bits representing 91 8-bit bytes. Each row of the Physical Sector shall consist of two Sync Frames with the first 1 456 Channel bits representing the first 91 bytes of each row of a Recording Frame and the second 1 456 Channel bits representing the second 91 bytes of each row of a Recording Frame.

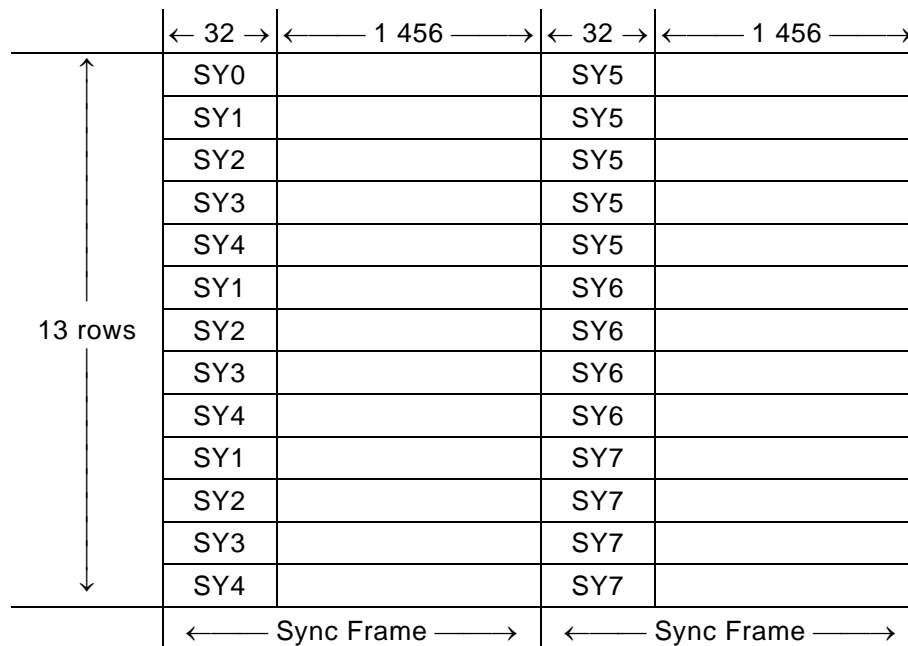

Figure 16 - Physical Sector

Recording of the Physical Sector shall start with the first Sync Frame of the first row, followed by the second Sync Frame of that row, and so on, row-by-row. The state of each SYNC Code and each subsequent set of 16 Channel bits shall follow the rules defined in 13.8.

Table 2 - SYNC Codes

State 1 and State 2 (next state is state 1)			
Primary SYNC codes		Secondary SYNC codes	
(msb)	(lsb)	(msb)	(lsb)
SY0 = 0001001001000100	0000000000010001	/ 0001001000000100	0000000000010001
SY1 = 0000010000000100	0000000000010001	/ 0000010001000100	0000000000010001
SY2 = 0001000000000100	0000000000010001	/ 0001000001000100	0000000000010001
SY3 = 0000100000000100	0000000000010001	/ 0000100001000100	0000000000010001
SY4 = 0010000000000100	0000000000010001	/ 0010000001000100	0000000000010001
SY5 = 0010001001000100	0000000000010001	/ 0010001000000100	0000000000010001
SY6 = 0010010010000100	0000000000010001	/ 0010000010000100	0000000000010001
SY7 = 0010010001000100	0000000000010001	/ 0010010000000100	0000000000010001
State 3 and State 4 (next state is state 1)			
Primary SYNC codes		Secondary SYNC codes	
(msb)	(lsb)	(msb)	(lsb)
SY0 = 1001001000000100	0000000000010001	/ 1001001001000100	0000000000010001
SY1 = 1000010001000100	0000000000010001	/ 1000010000000100	0000000000010001
SY2 = 1001000001000100	0000000000010001	/ 1001000000000100	0000000000010001
SY3 = 1000001001000100	0000000000010001	/ 1000001000000100	0000000000010001
SY4 = 1000100001000100	0000000000010001	/ 1000100000000100	0000000000010001
SY5 = 1000100100000100	0000000000010001	/ 1000000100000100	0000000000010001
SY6 = 1001000010000100	0000000000010001	/ 1000000010000100	0000000000010001
SY7 = 1000100010000100	0000000000010001	/ 1000000010000100	0000000000010001

13.7 Layout of a Recording Unit (RUN)

A RUN shall consist of an integer number ($M \geq 1$) of sets of 16 Physical Sectors, each from a single ECC Block. The M ECC Blocks shall be preceded by 8 Channel bits, which are meant to reduce possible influences of inaccuracies of the linking point, while the last 8 Channel bits of the last Physical Sector shall be discarded at recording. The 8 linking Channel bits and the next SYNC Code SY0 (chosen from State 1/2 or State 3/4) shall be chosen randomly, such that the runlength constraints specified in 13.5 are fulfilled.

Each RUN of M ECC Blocks ($M \geq 1$) starting with ECC Block N shall be recorded in the following way:

- 8 Channel bits for linking in ECC Block $N-1$,
- full ECC Blocks N to $N + M - 2$ (if $M \geq 2$),
- ECC Block $N + M - 1$, except for the last 8 Channel bits, which bits shall not be recorded.

The positioning of a Recording Unit is shown in Figure 17.

When the RUN starting with ECC Block N is to be recorded, and ECC Block $N-1$ has not yet been recorded, then the RUN shall be extended with a dummy ECC Block $N-1$ of which all Main Data bytes shall be set to (00).

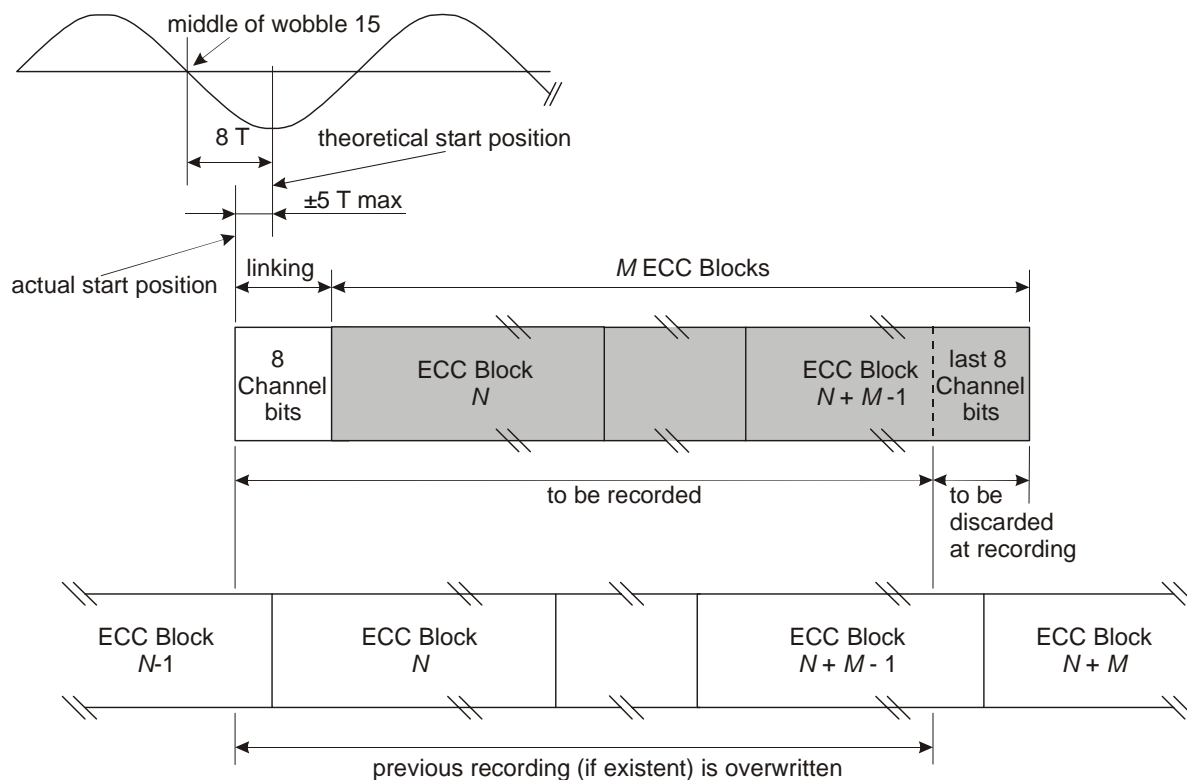

Figure 17 - Recording Unit

13.7.1 Recording Unit position

Each ECC Block, consisting of 16 Physical Sectors, shall correspond to 4 ADIP words (see 14.4.1.1). RUNs shall be mapped onto the structure of tracks (see 14.4), such that the Physical Sector Numbers (PSN), of which the 2 least significant bits have been discarded, correspond to the local Physical Address in ADIP (PAA). In mathematical form: $PSN = 4 \times PAA + i$, where $i = 0, 1, 2, \text{ or } 3$ (for example: Physical Sector Numbers (030000) to (030003) correspond to Physical ADIP Address (00C000)).

The reference for the theoretical start positions is wobble 15 following the ADIP word sync unit of the ADIP words of which the 2 least significant address bits are 00 (see 14.4.1.1 and Figure 21). The theoretical start position is 8 Channel bits after the nominal position of the zero crossing in the middle of the above mentioned wobble 15 of the wobble signal from Read channel 2.

The start of each recording shall be within ± 5 Channel bits of the theoretical start position. During writing the Channel bit clock shall be phase locked to the wobble frequency.

13.8 d.c. component suppression control

To ensure a reliable radial tracking and a reliable detection of the HF signals, the low frequency content of the stream of Channel bit patterns should be kept as low as possible. In order to achieve this, the Digital Sum Value (DSV, see 4.3) shall be kept as close to zero as possible. At the beginning of the modulation, the DSV shall be set to 0.

The different ways of diminishing the current value of the DSV are as follows:

- a) Choice of SYNC Codes between Primary or Secondary SYNC Codes.
- b) For the 8-bit bytes in the range 0 to 87, the Substitution table offers an alternative 16-bit Code Word for all States.

- c) For the 8-bit bytes in the range 88 to 255, when the prescribed State is 1 or 4, then the 16-bit Code Word can be chosen either from State 1 or from State 4, so as to ensure that the RLL requirement is met.

In order to use these possibilities, two data streams, Stream 1 and Stream 2, are generated. Stream 1 shall start with the Primary SYNC Code and Stream 2 with the Secondary SYNC Code of the same category of SYNC Codes. As both streams are modulated individually, they generate a different DSV because of the difference between the bit patterns of the Primary and Secondary SYNC Codes.

In the cases b) and c), there are two possibilities to represent a 8-bit byte. The DSV of each stream is computed up to the 8-bit byte preceding the 8-bit byte for which there is this choice. The stream with the lowest $|DSV|$ is selected and duplicated to the other stream. Then, one of the representations of the next 8-bit byte is entered into Stream 1 and the other into Stream 2. This operation is repeated each time case b) or c) occurs.

Whilst case b) always occurs at the same pattern position in both streams, case c) may occur in one of the streams and not in the other because, for instance, the next State prescribed by the previous 8-bit byte can be 2 or 3 instead of 1 or 4. In that case the following 3-step procedure shall be applied:

- 1) Compare the $|DSV|$ s of both streams.
- 2) If the $|DSV|$ of the stream in which case c) occurs is smaller than that of the other stream, then the stream in which case c) has occurred is chosen and duplicated to the other stream. One of the representations of the next 8-bit byte is entered into this stream and the other into the other stream.
- 3) If the $|DSV|$ of the stream in which case c) has occurred is larger than that of the other stream, then case c) is ignored and the 8-bit byte is represented according to the prescribed State.

In both cases b) and c), if the $|DSV|$ s are equal, the decision to choose Stream 1 or Stream 2 is implementation-defined.

The procedure for case a) shall be as follows:

- 1) At the end of each Sync Frame, whether or not case b) and or case c) have occurred, the accumulated DSVs of both streams are compared. The stream with the lower $|DSV|$ is selected and duplicated to the other stream. Then the next Primary SYNC Code and the Secondary SYNC Code of the proper category are inserted each in one of the streams.

Optionally the procedure for case a) can be extended in the following way:

- 2) If the DSV at the end of the resulting Sync Frame is greater than + 63 or smaller than -64, then the SYNC Code at the beginning of the Sync Frame is changed from Primary to Secondary or vice versa. If this yields a smaller $|DSV|$, the change is permanent, if the $|DSV|$ is not smaller, the original SYNC Code is retained.

During the DSV computation, the actual values of the DSV may vary between -1 000 and +1 000, thus it is recommended that the count range for the DSV be at least from -1 024 to +1 023.

14 Track format

14.1 Track shape

The area in the Information Zone (see 10.7) shall contain tracks formed from a single spiral groove. Each track shall form a 360° turn of a continuous spiral. The shape of each track is determined by the requirements in Section 5. Recordings shall be made on the groove.

The tracks in the Information Zone contain a phase modulated sinusoidal deviation from the nominal centrelines, called wobble, which contains addressing information.

The tracks shall be continuous in the Information Zone.

The groove tracks shall start at a radius of 22,00 mm max,
and end at a radius of 58,75 mm min (see also Annex A).

14.2 Track path

The track path shall be a continuous spiral from the inside (beginning of the Lead-in Zone) to the outside (end of the Lead-out Zone) when the disk rotates counter-clockwise as viewed from the optical head.

14.3 Track pitch

The track pitch is the distance measured between the average track centrelines of adjacent tracks, measured in the radial direction. The track pitch shall be $0,74 \mu\text{m} \pm 0,03 \mu\text{m}$. The track pitch averaged over the Information Zone shall be $0,74 \mu\text{m} \pm 0,01 \mu\text{m}$.

14.4 Track layout

The wobble of the tracks is a sinusoidal deviation from the nominal centrelines, with a wavelength of $4,2656 \mu\text{m} \pm 0,0450 \mu\text{m}$ (equivalent to 32 Channel bits). The Total Harmonic Distortion (THD) of the oscillator for generating the wobble sine wave shall be $\leq -40 \text{ dB}$.

The wobble is phase modulated by inverting wobble cycles. The information contained in the wobble modulation is called Address-in-Pregroove or ADIP (see 14.4.1.1).

14.4.1 ADIP information

The data to be recorded onto the disk must be aligned with the ADIP information modulated in the wobble. Therefore 93 wobbles shall correspond to 2 Sync Frames. Of each 93 wobbles, 8 wobbles are phase modulated with ADIP information (see Figure 18).

1 wobble equals 32 Channel bits (= 32T)

one ADIP unit = 8 modulated wobbles per 2 Sync Frames

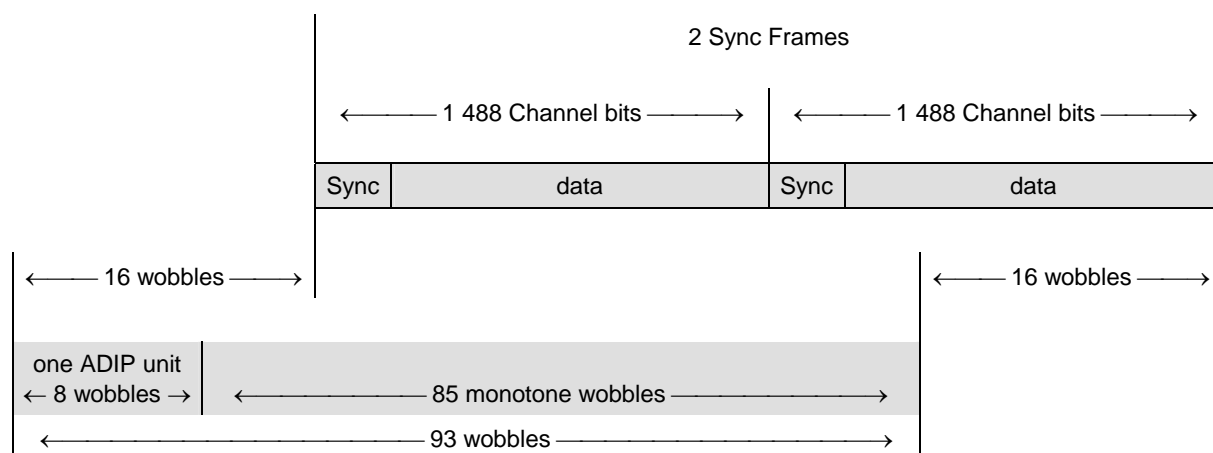

Figure 18 – General ADIP structure

14.4.1.1 ADIP word structure

52 ADIP units are grouped into one ADIP word each.

This means that one ADIP word corresponds to $4 \times 13 \times 2$ Sync Frames \equiv 4 Physical Sectors.

Each ADIP word shall consist of: 1 ADIP sync unit + 51 ADIP data units.

ADIP sync unit = 4 inverted wobbles for word sync + 4 monotone wobbles.

ADIP data unit = 1 inverted wobble for bit sync + 3 monotone wobbles + 4 wobbles representing one data bit. (see 14.4.1.3)

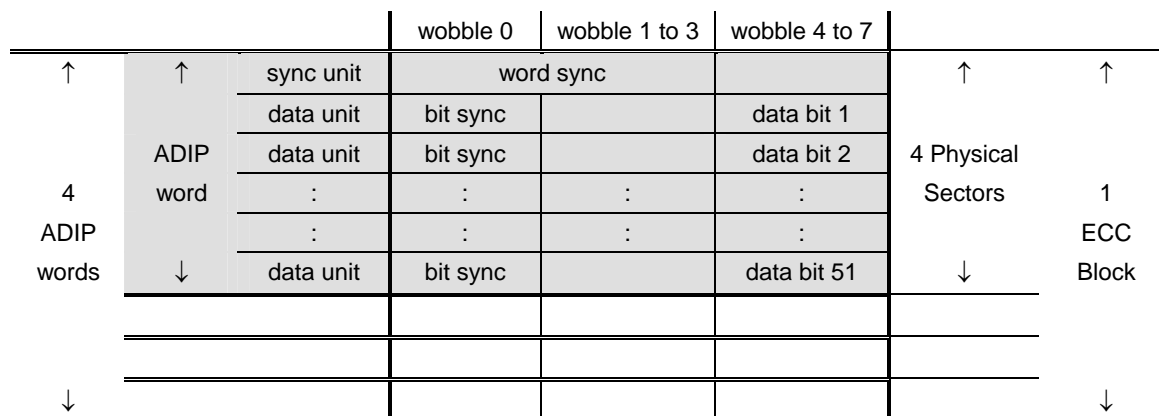

Figure 19 - ADIP word structure

The information contained in the data bits is as follows:

bit 1: this bit is **reserved** and shall be set to ZERO.

bits 2 to 23: these 22 bits contain a **Physical ADIP Address**.

Data bit 2 is the msb and data bit 23 is the lsb. The addresses increase by one for each next ADIP word.

The first address in the Information Zone shall be such that Physical ADIP Address (00C000) is located at radius $24,00^{+0,00}_{-0,20}$ mm .

Physical ADIP Address (098150), which is the first address corresponding to the Lead-out Zone, shall be located at a radius $\leq 58,00$ mm (see also Annex A).

bits 24 to 31: these 8 bits contain **auxiliary information** about the disk.

Bit 24 to 31 from 256 consecutive ADIP words, shall form one ADIP Aux Frame with 256 bytes of information. The first byte of each ADIP Aux Frame shall be located in an ADIP word with a Physical ADIP Address that is a multiple of 256 (Physical ADIP Address = (xxxx00)).

In the Lead-in Zone of the disk the auxiliary bytes shall be used for storing Physical format information. The contents of the 256 bytes are defined in Table 3 and 14.4.2.

In the Data Zone of the disk the auxiliary bytes may be used for storing Extended format information as defined in Annex B. If not used for such purpose all bytes shall be set to (00).

In the Lead-out Zone of the disk the auxiliary bytes shall be set to (00).

bits 32 to 51: these 20 bits contain **error correction parities** for the ADIP information. (see 14.4.1.2)

14.4.1.2 ADIP error correction

For the ADIP error correction the ADIP data bits are grouped into 4-bit nibbles. The mapping of the data bits into the nibble array is defined in Figure 20. Bit 0 is a dummy bit, which shall be considered as set to ZERO for the error corrector.

nibble N ₀	bit 0	bit 1	bit 2	bit 3	↑ 6 nibbles ADIP address ↓
nibble N ₁	bit 4	bit 5	:	:	
:	:	:	:	:	
:	bit 20	:	:	bit 23	↓ ↑ 2 nibbles AUX data
:	bit 24				
nibble N ₇	bit 28		:	bit 31	↓ ↑ 5 nibbles based R-S ECC ↓
nibble N ₈	bit 32	:	:	:	
:	:	:	:	:	
:	:	:	:	:	
nibble N ₁₂	bit 48	bit 49	bit 50	bit 51	

Figure 20 - ADIP error correction structure

A nibble-based RS (13,8,6) code is constructed, of which the 5 parity nibbles N₈ to N₁₂, are defined by the remainder polynomial R(x):

$$R(x) = \sum_{i=8}^{12} N_i x^{12-i} = I(x) x^5 \text{ mod } G_{PA}(x)$$

where

$$I(x) = \sum_{i=0}^7 N_i x^{7-i} \quad \text{and} \quad G_{PA}(x) = \prod_{k=0}^4 (x + \alpha^k)$$

α is the primitive root 0010 of the primitive polynomial $P(x) = x^4 + x + 1$

All bits of the 5 parity nibbles N₈ to N₁₂ shall be inverted before recording.

14.4.1.3 ADIP modulation rules

The ADIP units are modulated by inverting some of the 8 wobble cycles:

- PW is a positive wobble, which shall start moving towards the inside of the disk.
- NW is a negative wobble, which shall start moving towards the outside of the disk.
- all monotone wobbles shall be PWs.

Modulation of the ADIP word sync:

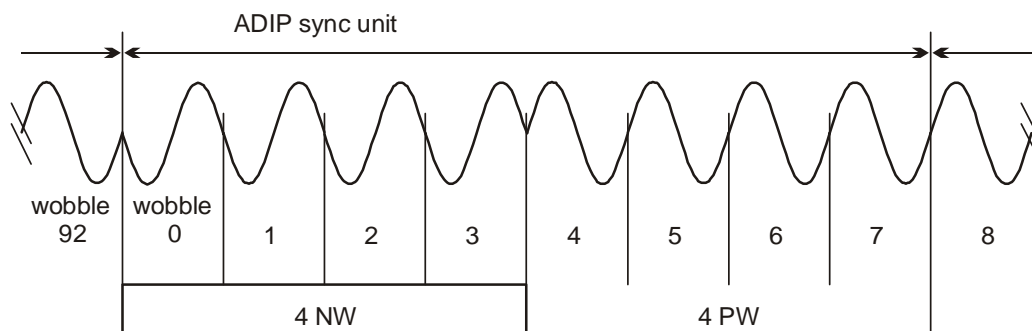

Modulation of an ADIP ZERO bit:

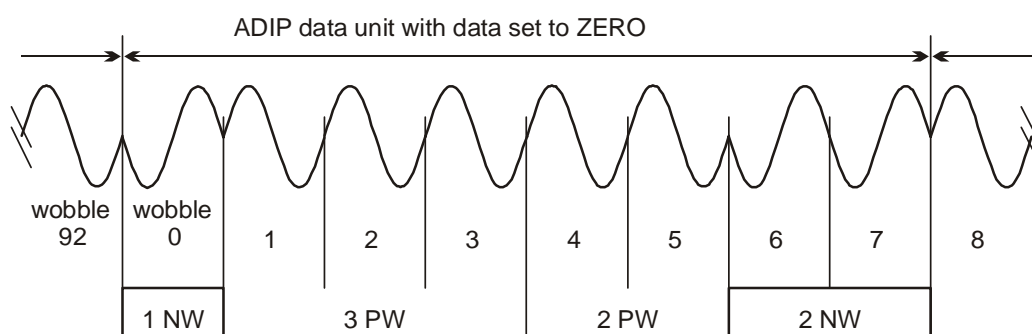

Modulation of an ADIP ONE bit:

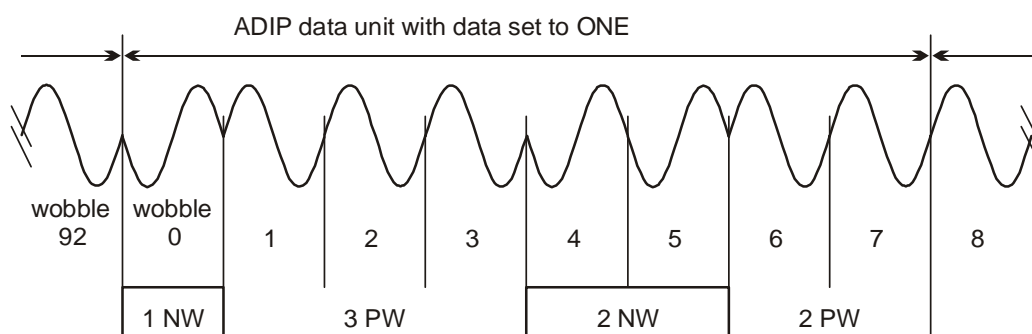

Figure 21 - ADIP modulation rules

14.4.2 Physical format information in ADIP

This information shall comprise the 256 bytes shown in Table 3. It contains disk information and values for the write strategy parameters to be used with the Optimum Power Control (OPC) algorithm to determine optimum laser power levels for writing (see Annex G and Annex I). The information is copied to the Control Data Zone (see 17.11.1) during initialization of the disk.

Table 3 - Physical format information

Byte number	Content	Number of bytes
0	Disk Category and Version Number	1
1	Disk size	1
2	Disk structure	1
3	Recording density	1
4 to 15	Data Zone allocation	12
16	General Flag bits	1
17	Disk Application Code	1
18	Extended Information Indicators	1
19 to 26	Disk Manufacturer ID	8
27 to 29	Media Type ID	3
30	Product revision number	1
31	number of Physical format information bytes in use in ADIP up to byte 63	1
32	Recording velocity range for the basic write strategy	1
33	Maximum read power at Reference velocity	1
34	P_{IND} at Reference velocity	1
35	ρ at Reference velocity	1
36	ε_1 at Reference velocity	1
37	ε_2 at Reference velocity	1
38	γ_{target} at Reference velocity	1
39	Maximum read power at Upper velocity	1
40	P_{IND} at Upper velocity	1
41	ρ at Upper velocity	1
42	ε_1 at Upper velocity	1
43	ε_2 at Upper velocity	1
44	γ_{target} at Upper velocity	1
45	Maximum read power at Intermediate velocity	1
46	P_{IND} at Intermediate velocity	1
47	ρ at Intermediate velocity	1
48	ε_1 at Intermediate velocity	1
49	ε_2 at Intermediate velocity	1
50	γ_{target} at Intermediate velocity	1
51	T_{top} first pulse duration	1
52	T_{mp} multi pulse duration	1
53	dT_{top} first pulse lead time	1
54	dT_{era} erase lead time at Reference velocity	1

Table 4 - Physical format information (concluded)

Byte number	Content	Number of bytes
55	dT _{era} erase lead time at Upper velocity	1
56	dT _{era} erase lead time at Intermediate velocity	1
57 to 63	Reserved – All (00)	7
64 to 95	Extended Information block 0	32
96 to 127	Extended Information block 1	32
128 to 159	Extended Information block 2	32
160 to 191	Extended Information block 3	32
192 to 223	Extended Information block 4	32
224 to 255	Extended Information block 5	32

This version of this document specifies two types of disks, with different recording velocity ranges. The specific write parameters for each recording velocity range shall be specified in separate blocks (EI blocks, see 14.4.2.3). The following types of disks (characterized by the so-called X-speed) have now been defined and their ADIP shall contain the EI Blocks as indicated in Table 5.

Table 5 - Types of disks

type of disk	basic write strategy bytes 32 to 63 (1x ~ 2,4x speed)	4x+ write strategy EI block format 1 (1,6x ~ 4x speed)	remarks
“2,4x”	+	–	this disk shall be suited for recording speeds between 3,49 & 8,44 m/s only
“4x”	+	+	this disk shall be suited for recording speeds between 3,49 & 8,44 m/s and between 5,77 & 13,95 m/s

+ shall be present – shall not be used (both write strategies support recording in full CAV mode)

14.4.2.1 General information – Bytes 0 to 31

Byte 0 - Disk Category and Version Number

Bits b_7 to b_4 shall specify the Disk Category,
bit b_7 shall be set to 1 indicating a disk according to the +R/+RW Format (see Clause 3),
bit b_6 shall be set to 0 indicating a single layer disk,
bits b_5 and b_4 shall be set to 01 indicating a +RW disk.

Bits b_3 to b_0 shall specify the Version Number,
they shall be set to 0010 indicating this Ecma Standard.
This Version Number identifies amongst others the definitions of the data in bytes 32 to 63. Drives not acquainted with the specific Version Number of a disk should not try to record on that disk using the information in bytes 32 to 63, which bytes contain the basic write strategy parameters (see Annex O).

Byte 1 - Disk size and maximum transfer rate

Bits b_7 to b_4 shall specify the disk size,
they shall be set to 0000, indicating a 120 mm disk (see also Annex A)

Bits b_3 to b_0 shall specify the maximum read transfer rate,
they shall be set to 1111 indicating no maximum read transfer rate is
specified

Byte 2 - Disk structure

Bits b_7 to b_4 shall be set to 0000

Bits b_3 to b_0 shall specify the type of the recording layer(s):
they shall be set to 0100, indicating a rewritable recording layer.

Byte 3 - Recording density

Bits b_7 to b_4 shall specify the average Channel bit length in the Information Zone,
they shall be set to 0000, indicating 0,133 μm

Bits b_3 to b_0 shall specify the average track pitch,
they shall be set to 0000, indicating an average track pitch of 0,74 μm

Bytes 4 to 15 - Data Zone allocation

Byte 4 shall be set to (00).

Bytes 5 to 7 shall be set to (030000) to specify PSN 196 608 of the first Physical Sector
of the Data Zone

Byte 8 shall be set to (00).

Bytes 9 to 11 shall be set to (26053F) to specify PSN 2 491 711 as the last possible
Physical Sector of the Data Zone (see also Annex A).

Bytes 12 to 15 shall be set to (00)

Byte 16 – General Flag bits

Bit b_7 shall be set to ZERO

Bit b_6 shall specify if the disk contains Extended format information in the ADIP Aux
Frames in the Data Zone related to the VCPS copy protection system,
shall be set to 0, indicating no Extended format information for VCPS is
present,
shall be set to 1, indicating the Data Zone contains Extended format
information for VCPS as defined in Annex B and the
VCPS System Description (see Annex N).

Bit b_5 is reserved for use in the Control Data Zone and shall be set to ZERO

Bits b_4 to b_0 are reserved and shall be set to 0 0000

Byte 17 – Disk Application Code

This byte can identify disks that are restricted to be used for special applications only. Drives
not able to identify the particular application related to a specific Disk Application Code or not
able to act according to the rules as defined for this particular application are not allowed to
write on a disk with such a code.

- (00) identifies a disk for General Purpose use
(no restrictions, all drives are allowed to write on a disk carrying this code),
all other codes are reserved.

Byte 18 – Extended Information indicators

Bits b₇ to b₆ are reserved and shall be set to 00

Bits b₅ to b₀ each of these bits shall indicate the presence of an Extended Information block.

Bit b_{*i*} shall be set to 1 if Extended Information block *i*, consisting of bytes (64 + *i*×32) to (95 + *i*×32), is in use. Else bit b_{*i*} shall be set to 0.

Bytes 19 to 26 – Disk Manufacturer ID

These 8 bytes shall identify the manufacturer of the disk. This name shall be represented by characters from the G0 set + SPACE according to ECMA-43. Trailing bytes not used shall be set to (00).

If the Disk Manufacturer ID is not used, these 8 bytes shall be set to (00)

Bytes 27 to 29 – Media Type ID

Disk manufacturers can have different types of media, which shall be specified by these 3 bytes. The specific type of disk is denoted in this field by characters from the G0 set + SPACE according to ECMA-43. Trailing bytes not used shall be set to (00).

If the **Media Type ID** is not used, these 3 bytes shall be set to (00)

NOTE

Disks with different characteristics shall be identified by different and unique combinations of Disk Manufacturer ID / Media Type ID. Therefore the contents of bytes 19 to 29 shall be approved by the licensors of the +RW system.

Byte 30 – Product revision number

This byte shall identify the product revision number in binary notation. All disks with the same Disk Manufacturer ID and the same **Media Type ID**, regardless of Product revision numbers, must have the same recording properties (only minor differences are allowed: Product revision numbers shall be irrelevant for recorders). The content of this byte can be chosen freely by the disk manufacturer.

If not used this byte shall be set to (00)

Byte 31 – number of Physical format information bytes in use in ADIP up to byte 63

This byte forms one 8-bit binary number indicating the number of bytes actually in use for the basic Physical format information (in bytes 0 to 63). It shall be set to (39) indicating that only the first 57 bytes of the Physical format information are used.

14.4.2.2 Basic write strategy parameters – Bytes 32 to 63

Byte 32 - Recording velocity range for the basic write strategy

This byte indicates the recording speed range of the disk for the basic write strategy parameters as defined in bytes 33 to 63 in this Physical format information, as a number *n* such that

$$n = 10 \times v_{\text{ref}} \text{ (} n \text{ rounded off to an integral value)}$$

It shall be

set to (23) indicating a linear velocity range for writing from 3,49 m/s (the Reference velocity) to 8,44 m/s allowing for CAV.

The Reference velocity is 3,49 m/s.

The Intermediate velocity is 5,95 m/s.

The Upper velocity is 8,44 m/s.

Byte 33 - Maximum read power, P_r at Reference velocity

This byte shall specify the maximum read power P_r in milliwatts at the Reference velocity as a number *n* such that

$$n = 20 \times (P_r - 0,7)$$

Byte 34 - P_{IND} at Reference velocity

P_{IND} is the starting value for the determination of P_{target} used in the OPC algorithm, see Annex I.

This byte shall specify the indicative value P_{IND} of P_{target} in milliwatts at the Reference velocity as a number n such that

$$n = 20 \times (P_{IND} - 5)$$

Byte 35 - ρ at Reference velocity

This byte shall specify the write power multiplication factor ρ at the Reference velocity used in the OPC algorithm (see Annex I) as a number n such that

$$n = 100 \times \rho$$

Byte 36 - ε_1 at Reference velocity

This byte shall specify the Erase/Write power ratio ε_1 at the Reference velocity used in the OPC algorithm (see Annex I) as a number n such that

$$n = 200 \times \varepsilon_1$$

Byte 37 - ε_2 at Reference velocity

This byte shall specify the Cooling/Write power ratio ε_2 at the Reference velocity used in the OPC algorithm (see Annex I) as a number n such that

$$n = 200 \times \varepsilon_2$$

Byte 38 - γ_{target} at Reference velocity

This byte shall specify the target value for γ , γ_{target} at the Reference velocity used in the OPC algorithm (see Annex I) as a number n such that

$$n = 20 \times \gamma_{target}$$

Byte 39 - Maximum read power at Upper velocity

This byte shall specify the maximum read power P_r in milliwatts at the Upper velocity as a number n such that

$$n = 20 \times (P_r - 0,7)$$

Byte 40 - P_{IND} at Upper velocity

P_{IND} is the starting value for the determination of P_{target} used in the OPC algorithm, see Annex I.

This byte shall specify the indicative value P_{IND} of P_{target} in milliwatts at the Upper velocity as a number n such that

$$n = 20 \times (P_{IND} - 5)$$

Byte 41 - ρ at Upper velocity

This byte shall specify the write power multiplication factor ρ at the Upper velocity used in the OPC algorithm (see Annex I) as a number n such that

$$n = 100 \times \rho$$

Byte 42 - ε_1 at Upper velocity

This byte shall specify the Erase/Write power ratio ε_1 at the Upper velocity used in the OPC algorithm (see Annex I) as a number n such that

$$n = 200 \times \varepsilon_1$$

Byte 43 - ε_2 at Upper velocity

This byte shall specify the Cooling/Write power ratio ε_2 at the Upper velocity used in the OPC algorithm (see Annex I) as a number n such that

$$n = 200 \times \varepsilon_2$$

Byte 44 - γ_{target} at Upper velocity

This byte shall specify the target value for γ , γ_{target} at the Upper velocity used in the OPC algorithm (see Annex I) as a number n such that

$$n = 20 \times \gamma_{\text{target}}$$

Byte 45 - Maximum read power at Intermediate velocity

This byte shall specify the maximum read power P_r in milliwatts at the Intermediate velocity as a number n such that

$$n = 20 \times (P_r - 0,7)$$

Byte 46 - P_{IND} at Intermediate velocity

P_{IND} is the starting value for the determination of P_{target} used in the OPC algorithm, see Annex I.

This byte shall specify the indicative value P_{IND} of P_{target} in milliwatts at the Intermediate velocity as a number n such that

$$n = 20 \times (P_{\text{IND}} - 5)$$

Byte 47 - ρ at Intermediate velocity

This byte shall specify the write power multiplication factor ρ at the Intermediate velocity used in the OPC algorithm (see Annex I) as a number n such that

$$n = 100 \times \rho$$

Byte 48 - ε_1 at Intermediate velocity

This byte shall specify the Erase/Write power ratio ε_1 at the Intermediate velocity used in the OPC algorithm (see Annex I) as a number n such that

$$n = 200 \times \varepsilon_1$$

Byte 49 - ε_2 at Intermediate velocity

This byte shall specify the Cooling/Write power ratio ε_2 at the Intermediate velocity used in the OPC algorithm (see Annex I) as a number n such that

$$n = 200 \times \varepsilon_2$$

Byte 50 - γ_{target} at Intermediate velocity

This byte shall specify the target value for γ , γ_{target} at the Intermediate velocity used in the OPC algorithm (see Annex I) as a number n such that

$$n = 20 \times \gamma_{\text{target}}$$

Byte 51 – T_{top} first pulse duration

This byte shall specify the duration of the first pulse of the multi pulse train for recording (see Annex G). The first pulse duration consists of two contributions: a variable part and a fixed part ($T_{\text{top}} = T_{\text{top,var}} + T_{\text{top,fix}}$).

Bits 7 to 4 of this byte shall specify the variable part as a fraction of the Channel bit clock period.

Bits 3 to 0 of this byte shall specify the fixed part expressed in nanoseconds. (see Table 6).

Bit combinations not specified in Table 6 shall not be used.

Table 6 – First pulse duration

bits 7 to 4	$T_{top,var}$ (T)	bits 3 to 0	$T_{top,fix}$ (ns)
0000	0	0000	reserved
0001	1/6	0001	2
0010	2/6	0010	4
0011 to 1111	reserved	0011	6
		0100	8
		0101	10
		0110	12
		0111	14
		1000 to 1111	reserved

Byte 52 – T_{mp} multi pulse duration

This byte shall specify the duration of the second and higher pulses of the multi pulse train for recording (see Annex G). The multi pulse duration consists of two contributions: a variable part and a fixed part ($T_{mp} = T_{mp,var} + T_{mp,fix}$).

Bits 7 to 4 of this byte shall specify the variable part as a fraction of the Channel bit clock period.

Bits 3 to 0 of this byte shall specify the fixed part expressed in nanoseconds. (see Table 7)

Bit combinations not specified in Table 7 shall not be used.

Table 7 – Multi pulse duration

bits 7 to 4	$T_{mp,var}$ (T)	bits 3 to 0	$T_{mp,fix}$ (ns)
0000	0	0000	reserved
0001	1/6	0001	2
0010 to 1111	reserved	0010	4
		0011	6
		0100	8
		0101	10
		0110 to 1111	reserved

Byte 53 – dT_{top} first pulse lead time

Bits 7 to 4 of this byte shall specify the lead time of the first pulse of the multi pulse train for recording, relative to the trailing edge of the first Channel bit of the data pulse (see Annex G). The value is expressed as a fraction of the actual Channel bit clock period T (see Table 8). Bits 3 to 0 of this byte shall be set to 0000.

Bit combinations not specified in Table 8 shall not be used.

Table 8 – First pulse lead-time

bits 7 to 4	dT_{top} lead time (T)
0000	0
0001	1/6
0010	2/6
0011	3/6
0100	4/6
0101 to 1111	reserved

Byte 54 – dT_{era} erase lead time at Reference velocity

Bits 7 to 4 of this byte shall specify the lead time of the erase pulse for recording, relative to the trailing edge of the last Channel bit of the data pulse (see Annex G). The value is expressed as a fraction of the actual Channel bit clock period T (see Table 9). Bits 3 to 0 of this byte shall be set to 0000.

Bit combinations not specified in Table 9 shall not be used.

Byte 55 – dT_{era} erase lead time at Upper velocity

Bits 7 to 4 of this byte shall specify the lead time of the erase pulse for recording, relative to the trailing edge of the last Channel bit of the data pulse (see Annex G). The value is expressed as a fraction of the actual Channel bit clock period T (see Table 9). Bits 3 to 0 of this byte shall be set to 0000.

Bit combinations not specified in Table 9 shall not be used.

Byte 56 – dT_{era} erase lead time at Intermediate velocity

Bits 7 to 4 of this byte shall specify the lead time of the erase pulse for recording, relative to the trailing edge of the last Channel bit of the data pulse (see Annex G). The value is expressed as a fraction of the actual Channel bit clock period T (see Table 9). Bits 3 to 0 of this byte shall be set to 0000.

Bit combinations not specified in Table 9 shall not be used.

Table 9 – Erase lead-time

bits 7 to 4	dT_{era} lead time (T)
0000	0
0001	1/6
0010	2/6
0011	3/6
0100 to 1100	reserved
1101	– 3/6
1110	– 2/6
1111	– 1/6

Bytes 57 to 63 - Reserved - All (00)

These bytes shall be set to all (00).

14.4.2.3 Extended Information blocks – Bytes (64 + $i \times 32$) to (95 + $i \times 32$)

($i = 0$ to 5)

Extended Information (EI) blocks are meant to facilitate future extensions. Each such block consists of 32 bytes. These bytes can hold for instance parameters for alternative write strategies or other advanced parameters. If a set of parameters does not fit in one Extended Information block, additional continuation blocks can be added, which additional blocks are identified by a Continuation bit.

The presence of an Extended Information block shall be indicated by the appropriate bit in byte 18. If an Extended Information block is not used, all 32 bytes shall be set to (00).

Byte (64 + $i \times 32$) Extended Information block i Format number / Continuation bit

Bits b_6 to b_0 indicate the Format number which identifies the definitions of the data in bytes (65 + $i \times 32$) to (95 + $i \times 32$).

If bit b_7 is set to ONE, the related Extended Information block is not an independent block but a continuation of the preceding Extended Information block. The Format number in a continuation block shall be the same as the Format number in the preceding Extended Information block.

A disk can have several Extended Information blocks. The contents of blocks with different Format numbers have to be interpreted each according to their respective definitions. The contents of blocks with the same Format number are interpreted in the same way; the parameters specified in these blocks however can have different values.

Drives not acquainted with the specific Format number in block i , should not use the parameters in this Extended Information block (see Annex O).

NOTE

The contents of an EI block are identified by the Format number of the block only. The position of the EI block in the ADIP Aux Frame is irrelevant for this, so an EI block with Format number n could be allocated at any position i . Therefore drives should always check the Format numbers in the EI blocks to be sure that the write strategies are correctly interpreted.

Bytes (65 + $i \times 32$) to (95 + $i \times 32$)

Each parameter set defined for these bytes shall be identified by a unique Format number.

14.4.2.3.1 Extended Information for the “4x” write strategy

This Extended Information block specifies the parameters for a write strategy usable at speeds ranging from 5,77 m/s up to 13,95 m/s, which is equivalent to 1,66x up to 4x the basic DVD speed (3,49 m/s). This range allows for CAV recording at about 2300 rpm.

NOTE

This speed range is overlapping with the range indicated for the basic write strategy.

For optimum results, some parameters are defined at three different speeds:

- the Lower velocity, which shall be 5,77 m/s,
- the Intermediate velocity, which shall be 9,86 m/s and
- the Upper velocity, which shall be 13,95 m/s.

If a disk can not be recorded under these “4x” conditions, this EI block shall not be used (all bytes set to (00) and related Extended Information indicator bit set to ZERO).

Byte 18 – Extended Information indicators

This byte shall be set to xxxx xxx1 indicating Extended Information block 0 is in use.

Table 10 - Extended Information block 0

Byte number	Content	Number of bytes
64	Continuation bit / Format number	1
65	Reserved - set to (00)	1
66	Lower recording velocity for the parameter set in this EI block	1
67	Upper recording velocity for the parameter set in this EI block	1
68	Maximum read power at Lower velocity	1
69	P_{IND} at Lower velocity	1
70	ρ at Lower velocity	1
71	ε_1 at Lower velocity	1
72	ε_2 at Lower velocity	1
73	γ_{target} at Lower velocity	1
74	Maximum read power at Upper velocity	1
75	P_{IND} at Upper velocity	1
76	ρ at Upper velocity	1
77	ε_1 at Upper velocity	1
78	ε_2 at Upper velocity	1
79	γ_{target} at Upper velocity	1
80	Maximum read power at Intermediate velocity	1
81	P_{IND} at Intermediate velocity	1
82	ρ at Intermediate velocity	1
83	ε_1 at Intermediate velocity	1
84	ε_2 at Intermediate velocity	1
85	γ_{target} at Intermediate velocity	1
86	T_{top} first pulse duration	1
87	T_{mp} multi pulse duration	1
88	dT_{top} first pulse lead time at Lower velocity	1
89	dT_{top} first pulse lead time at Upper velocity	1
90	dT_{top} first pulse lead time at Intermediate velocity	1
91	dT_{era} erase lead time at Lower velocity	1
92	dT_{era} erase lead time at Upper velocity	1
93	dT_{era} erase lead time at Intermediate velocity	1
94 to 95	Reserved - All (00)	2

Byte 64 - Extended Information block 0 Continuation bit / Format number

This byte shall be set to 0000 0001 indicating Format 1 and this block not being a continuation block, for which bytes 65 to 95 have the following meaning:

Byte 65 - Reserved

This byte is reserved and shall be set to (00)

Byte 66 – Lower recording velocity for the parameter set in this EI block

This byte indicates the lowest recording velocity of the disk for the parameters as defined in this EI block. This recording velocity shall be specified as a number n such that

$$n = 4 \times v_{\text{Lower,EI } 0} \text{ (} n \text{ rounded off to an integral value)}$$

It shall be

set to (17) indicating a Lower writing speed of about 5,75 m/s.

Byte 67 – Upper recording velocity for the parameter set in this EI block

This byte indicates the highest recording velocity of the disk for the parameters as defined in this EI block. This recording velocity shall be specified as a number n such that

$$n = 4 \times v_{\text{Upper,EI } 0} \text{ (} n \text{ rounded off to an integral value)}$$

It shall be

set to (38) indicating an Upper writing speed of about 14 m/s.

Byte 68 - Maximum read power, P_r at Lower velocity

This byte shall specify the maximum read power P_r in milliwatts at the Lower velocity as a number n such that

$$n = 20 \times (P_r - 0,7)$$

Byte 69 - P_{IND} at Lower velocity

P_{IND} is the starting value for the determination of P_{target} used in the OPC algorithm, see Annex I.

This byte shall specify the indicative value P_{IND} of P_{target} in milliwatts at the Lower velocity as a number n such that

$$n = 5 \times (P_{\text{IND}} - 5)$$

Byte 70 - ρ at Lower velocity

This byte shall specify the write power multiplication factor ρ at the Lower velocity used in the OPC algorithm (see Annex I) as a number n such that

$$n = 100 \times \rho$$

Byte 71 - ε_1 at Lower velocity

This byte shall specify the Erase/Write power ratio ε_1 at the Lower velocity used in the OPC algorithm (see Annex I) as a number n such that

$$n = 200 \times \varepsilon_1$$

Byte 72 - ε_2 at Lower velocity

This byte shall specify the Cooling/Write power ratio ε_2 at the Lower velocity used in the OPC algorithm (see Annex I) as a number n such that

$$n = 200 \times \varepsilon_2$$

Byte 73 - γ_{target} at Lower velocity

This byte shall specify the target value for γ , γ_{target} at the Lower velocity used in the OPC algorithm (see Annex I) as a number n such that

$$n = 20 \times \gamma_{\text{target}}$$

Byte 74 - Maximum read power, P_r at Upper velocity

This byte shall specify the maximum read power P_r in milliwatts at the Upper velocity as a number n such that

$$n = 20 \times (P_r - 0,7)$$

Byte 75 - P_{IND} at Upper velocity

P_{IND} is the starting value for the determination of P_{target} used in the OPC algorithm, see Annex I.

This byte shall specify the indicative value P_{IND} of P_{target} in milliwatts at the Upper velocity as a number *n* such that

$$n = 5 \times (P_{IND} - 5)$$

Byte 76 - ρ at Upper velocity

This byte shall specify the write power multiplication factor ρ at the Upper velocity used in the OPC algorithm (see Annex I) as a number *n* such that

$$n = 100 \times \rho$$

Byte 77 - ε₁ at Upper velocity

This byte shall specify the Erase/Write power ratio ε₁ at the Upper velocity used in the OPC algorithm (see Annex I) as a number *n* such that

$$n = 200 \times \varepsilon_1$$

Byte 78 - ε₂ at Upper velocity

This byte shall specify the Cooling/Write power ratio ε₂ at the Upper velocity used in the OPC algorithm (see Annex I) as a number *n* such that

$$n = 200 \times \varepsilon_2$$

Byte 79 - γ_{target} at Upper velocity

This byte shall specify the target value for γ, γ_{target} at the Upper velocity used in the OPC algorithm (see Annex I) as a number *n* such that

$$n = 20 \times \gamma_{target}$$

Byte 80 - Maximum read power, P_r at Intermediate velocity

This byte shall specify the maximum read power P_r in milliwatts at the Intermediate velocity as a number *n* such that

$$n = 20 \times (P_r - 0,7)$$

Byte 81 - P_{IND} at Intermediate velocity

P_{IND} is the starting value for the determination of P_{target} used in the OPC algorithm, see Annex I.

This byte shall specify the indicative value P_{IND} of P_{target} in milliwatts at the Intermediate velocity as a number *n* such that

$$n = 5 \times (P_{IND} - 5)$$

Byte 82 - ρ at Intermediate velocity

This byte shall specify the write power multiplication factor ρ at the Intermediate velocity used in the OPC algorithm (see Annex I) as a number *n* such that

$$n = 100 \times \rho$$

Byte 83 - ε₁ at Intermediate velocity

This byte shall specify the Erase/Write power ratio ε₁ at the Intermediate velocity used in the OPC algorithm (see Annex I) as a number *n* such that

$$n = 200 \times \varepsilon_1$$

Byte 84 - ε_2 at Intermediate velocity

This byte shall specify the Cooling/Write power ratio ε_2 at the Intermediate velocity used in the OPC algorithm (see Annex I) as a number n such that

$$n = 200 \times \varepsilon_2$$

Byte 85 - γ_{target} at Intermediate velocity

This byte shall specify the target value for γ , γ_{target} at the Intermediate velocity used in the OPC algorithm (see Annex I) as a number n such that

$$n = 20 \times \gamma_{\text{target}}$$

Byte 86 – T_{top} first pulse duration

This byte shall specify the duration of the first pulse of the multi pulse train for recording (see Annex G). The first pulse duration consists of two contributions: a variable part and a fixed part ($T_{\text{top}} = T_{\text{top,var}} + T_{\text{top,fix}}$).

Bits 7 to 4 of this byte shall specify the variable part as a fraction of the Channel bit clock period.

Bits 3 to 0 of this byte shall specify the fixed part expressed in nanoseconds. (see Table 11).

Bit combinations not specified in Table 11 shall not be used.

Table 11 – First pulse duration

bits 7 to 4	$T_{\text{top,var}}$ (T)	bits 3 to 0	$T_{\text{top,fix}}$ (ns)
0000	0	0000	reserved
0001	1/16	0001	0,6
0010	2/16	0010	1,2
0011	3/16	0011	1,8
0100	4/16	0100	2,4
0101	5/16	0101	3,0
0110	6/16	0110	3,6
0111	7/16	0111	4,2
1000	8/16	1000	4,8
1001 to 1111	reserved	1001	5,4
		1010	6,0
		1011	6,6
		1100	7,2
		1101	7,8
		1110	8,4
		1111	9,0

Byte 87 – T_{mp} multi pulse duration

This byte shall specify the duration of the second and higher pulses of the multi pulse train for recording (see Annex G). The multi pulse duration consists of two contributions: a variable part and a fixed part ($T_{mp} = T_{mp,var} + T_{mp,fix}$).

Bits 7 to 4 of this byte shall specify the variable part as a fraction of the Channel bit clock period.

Bits 3 to 0 of this byte shall specify the fixed part expressed in nanoseconds. (see Table 12)

Bit combinations not specified in Table 12 shall not be used.

Table 12 – Multi pulse duration

bits 7 to 4	$T_{mp,var}$ (T)	bits 3 to 0	$T_{mp,fix}$ (ns)
0000	0	0000	reserved
0001	1/16	0001	0,6
0010	2/16	0010	1,2
0011	3/16	0011	1,8
0100	4/16	0100	2,4
0101	5/16	0101	3,0
0110	6/16	0110	3,6
0111	7/16	0111	4,2
1000	8/16	1000	4,8
1001 to 1111	reserved	1001	5,4
		1010	6,0
		1011 to 1111	reserved

Byte 88 – dT_{top} first pulse lead time at Lower velocity

Bits 7 to 4 of this byte shall specify the lead time of the first pulse of the multi pulse train for recording, relative to the trailing edge of the first Channel bit of the data pulse (see Annex G). The value is expressed as a fraction of the actual Channel bit clock period T (see Table 13). Bits 3 to 0 of this byte shall be set to 0000.

Bit combinations not specified in Table 13 shall not be used.

Byte 89 – dT_{top} first pulse lead time at Upper velocity

Bits 7 to 4 of this byte shall specify the lead time of the first pulse of the multi pulse train for recording, relative to the trailing edge of the first Channel bit of the data pulse (see Annex G). The value is expressed as a fraction of the actual Channel bit clock period T (see Table 13). Bits 3 to 0 of this byte shall be set to 0000.

Bit combinations not specified in Table 13 shall not be used.

Byte 90 – dT_{top} first pulse lead time at Intermediate velocity

Bits 7 to 4 of this byte shall specify the lead time of the first pulse of the multi pulse train for recording, relative to the trailing edge of the first Channel bit of the data pulse (see Annex G). The value is expressed as a fraction of the actual Channel bit clock period T (see Table 13). Bits 3 to 0 of this byte shall be set to 0000.

Bit combinations not specified in Table 13 shall not be used.

Table 13 – First pulse lead-time

bits 7 to 4	dT_{top} lead time (T)
0000	0
0001	1/16
0010	2/16
0011	3/16
0100	4/16
0101	5/16
0110	6/16
0111	7/16
1000 to 1011	reserved
1100	-4/16
1101	-3/16
1110	-2/16
1111	-1/16

Byte 91 – dT_{era} erase lead time at Lower velocity

Bits 7 to 4 of this byte shall specify the lead time of the erase pulse for recording, relative to the trailing edge of the last Channel bit of the data pulse (see Annex G). The value is expressed as a fraction of the actual Channel bit clock period T (see Table 14). Bits 3 to 0 of this byte shall be set to 0000.

Bit combinations not specified in Table 14 shall not be used.

Byte 92 – dT_{era} erase lead time at Upper velocity

Bits 7 to 4 of this byte shall specify the lead time of the erase pulse for recording, relative to the trailing edge of the last Channel bit of the data pulse (see Annex G). The value is expressed as a fraction of the actual Channel bit clock period T (see Table 14). Bits 3 to 0 of this byte shall be set to 0000.

Bit combinations not specified in Table 14 shall not be used.

Byte 93 – dT_{era} erase lead time at Intermediate velocity

Bits 7 to 4 of this byte shall specify the lead time of the erase pulse for recording, relative to the trailing edge of the last Channel bit of the data pulse (see Annex G). The value is expressed as a fraction of the actual Channel bit clock period T (see Table 14). Bits 3 to 0 of this byte shall be set to 0000.

Bit combinations not specified in Table 14 shall not be used.

Table 14 – Erase lead-time

bits 7 to 4	dT_{era} lead time (T)
0000	4/16
0001	5/16
0010	6/16
0011	7/16
0100	8/16
0101	9/16
0110	10/16
0111	11/16
1000	-4/16
1001	-3/16
1010	-2/16
1011	-1/16
1100	0
1101	1/16
1110	2/16
1111	3/16

Bytes 94 to 95 - Reserved - All (00)

These bytes shall be set to all (00).

Section 4 - Format of the Information Zone

15 General description of the Information Zone

The Information Zone shall contain all information on the disk relevant for data interchange. It shall be divided in three parts: the Lead-in Zone, the Data Zone and the Lead-out Zone. In double-sided disks there is one Information Zone per side. The Data Zone is intended for the recording of User Data. The Lead-in Zone contains control information and an area for disk and drive testing. The Lead-out Zone allows for a continuous smooth lead-out and also contains control information and a disk and drive test Zone.

The Lead-in Zone, the Data Zone and the Lead-out Zone constitute the Rewritable area in which the information is recorded using the Phase change effect.

16 Layout of the Information Zone

The Information Zone of single-sided and of each side of double-sided disks shall be sub-divided as shown in Table 15. The radii indicated in Table 15 for some of the Zones are the nominal values of the centre of the first (or last) track of the Zone.

Table 15 - Layout of the Information Zone of a fully formatted disk (see also Annex A)

	Description	Nominal radius in mm	PSN of the first Physical Sector	Number of Physical Sectors
Lead-in	Initial Zone	start 22,000 mm	(01D830)	52 304 nominal
	Inner Disk Test Zone	start 23,400 mm	(02A480)	2 048
	Inner Drive Test Zone		(02AC80)	12 288
	Guard Zone 1		(02DC80)	512
	Reserved Zone 1	start 23,782 mm	(02DE80)	4 096
	Reserved Zone 2	start 23,886 mm	(02EE80)	64
	Inner Disk Identification Zone		(02EEC0)	256
	Reserved Zone 3		(02EFC0)	64
	Reference Code Zone	start 23,896 mm	(02F000)	32
	Buffer Zone 1		(02F020)	480
	Control Data Zone		(02F200)	3 072
	Buffer Zone 2		(02FE00)	512
Data	Data Zone	start 24,000 mm	(030000)	2 295 104
Lead-out	Buffer Zone 3	start 58,000 mm	(260540)	768
	Outer Disk Identification Zone		(260840)	256
	Guard Zone 2		(260940)	4 096
	Reserved Zone 4	start 58,053 mm	(261940)	4 096
	Outer Drive Test Zone		(262940)	12 288
	Outer Disk Test Zone		(265940)	2 048
	Guard Zone 3	start 58,246 mm end ≥ 58,500 mm	(266140)	24 400 nominal

16.1 Physical Sector Numbers (PSNs)

The first Physical Sector of the Data Zone shall have PSN (030000). The PSNs increase by 1 for each next Physical Sector in the whole Information Zone. (Figure 22).

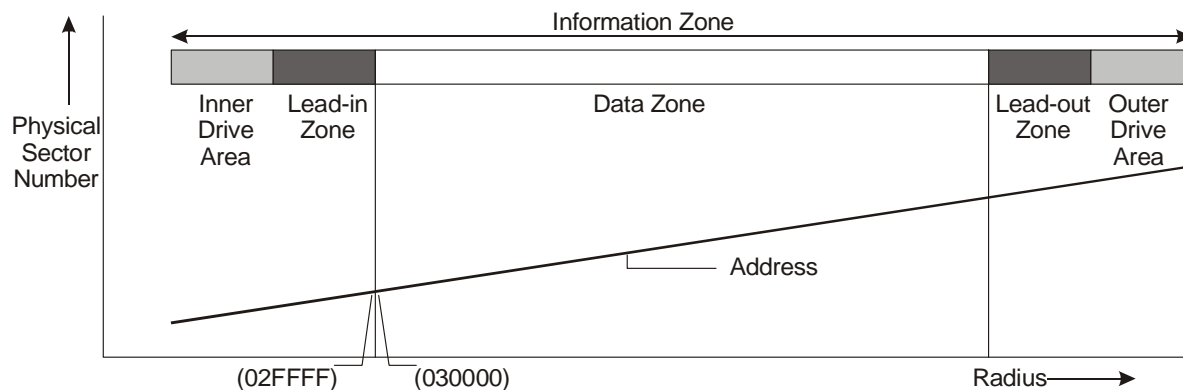

Figure 22 - Physical Sector numbering

17 Lead-in Zone

The Lead-in Zone is the innermost Zone of the Information Zone. It shall consist of the parts shown in Figure 23.

The Physical Sector Number of the first and last Physical Sector of each part is indicated in Figure 23 in hexadecimal and decimal notation and the number of Physical Sectors in each part is indicated in decimal notation.

A maiden disk does not have any data recorded in the Lead-in Zone. After finalization of the disk, the Lead-in Zone shall be recorded according to 17.1 to 17.12.

17.1 Initial Zone

The Main Data of the Data Frames in this Zone, when recorded, shall be set to all (00). The recording in the Initial Zone shall start at radius 22,6 mm max. This Ecma Standard does not specify the number of Physical Sectors in the Initial Zone.

NOTE

The Physical Sector Number of the first Physical Sector of the Data Zone is large enough so as to prevent a Physical Sector Number ≤ 0 to occur in the Initial Zone.

17.2 Inner Disk Test Zone

2 048 Physical Sectors reserved for disk manufacturer testing. This Zone shall be filled with Main Data set to (00).

17.3 Inner Drive Test Zone

12 288 Physical Sectors reserved for drive testing and OPC algorithm. This Zone shall be filled with Main Data set to (00).

17.4 Guard Zone 1

This Guard Zone is used as a protection for separating test writing zones from information zones containing user data. If recorded, this Zone shall be filled with Main Data set to (00). This zone shall contain 512 Physical Sectors.

17.5 Reserved Zone 1

4 096 Physical Sectors (= 256 ECC Blocks) reserved for Defect Management use. If not used all bytes shall be set to (00).

17.6 Reserved Zone 2

64 Physical Sectors reserved for Defect Management use. If not used all bytes shall be set to (00).

Physical Sector 173 183 Physical Sector 173 184	Initial Zone all Physical Sectors with Main Data set to (00)	Physical Sector (02A47F) Physical Sector (02A480)
Physical Sector 175 231 Physical Sector 175 232	Inner Disk Test Zone 2 048 Physical Sectors	Physical Sector (02AC7F) Physical Sector (02AC80)
Physical Sector 187 519 Physical Sector 187 520	Inner Drive Test Zone 12 288 Physical Sectors	Physical Sector (02DC7F) Physical Sector (02DC80)
Physical Sector 188 031 Physical Sector 188 032	Guard Zone 1 512 Physical Sectors with Main Data set to (00)	Physical Sector (02DE7F) Physical Sector (02DE80)
Physical Sector 192 127 Physical Sector 192 128	Reserved Zone 1 4 096 Physical Sectors	Physical Sector (02EE7F) Physical Sector (02EE80)
Physical Sector 192 191 Physical Sector 192 192	Reserved Zone 2 64 Physical Sectors	Physical Sector (02EEBF) Physical Sector (02EEC0)
Physical Sector 192 447 Physical Sector 192 448	Inner Disk Identification Zone 256 Physical Sectors	Physical Sector (02EFBF) Physical Sector (02EFC0)
Physical Sector 192 511 Physical Sector 192 512	Reserved Zone 3 64 Physical Sectors	Physical Sector (02EFFF) Physical Sector (02F000)
Physical Sector 192 543 Physical Sector 192 544	Reference Code Zone 32 Physical Sectors	Physical Sector (02F01F) Physical Sector (02F020)
Physical Sector 193 023 Physical Sector 193 024	Buffer Zone 1 480 Physical Sectors with Main Data set to (00)	Physical Sector (02F1FF) Physical Sector (02F200)
Physical Sector 196 095 Physical Sector 196 096	Control Data Zone 3 072 Physical Sectors	Physical Sector (02FDFF) Physical Sector (02FE00)
Physical Sector 196 607 Physical Sector 196 608	Buffer Zone 2 512 Physical Sectors	Physical Sector (02FFFF) Physical Sector (030000)
	Data Zone	

Figure 23 - Lead-in Zone

17.7 Inner Disk Identification Zone

256 Physical Sectors reserved for information agreed upon by the data interchange parties. Each set of 16 Physical Sectors from one ECC Block is either a Disk Control Block (DCB) (see Clause 22) or recorded with all (00) Main Data. Each ECC Block in this Zone following one recorded with all (00) Main Data shall also be recorded with all (00) Main Data.

17.8 Reserved Zone 3

64 Physical Sectors reserved for Defect Management use. If not used all bytes shall be set to (00).

17.9 Reference Code Zone

The recorded Reference Code Zone shall consist of the 32 Physical Sectors from two ECC Blocks which generate a specific Channel bit pattern on the disk. This shall be achieved by setting to (AC) all 2 048 Main Data bytes of each corresponding Data Frame. Moreover, no scrambling shall be applied to these Data Frames, except to the first 160 Main Data bytes of the first Data Frame of each ECC Block.

17.10 Buffer Zone 1

This Zone shall consist of 480 Physical Sectors from 30 ECC Blocks. The Main Data of the Data Frames in this Zone shall be set to all (00).

17.11 Control Data Zone

This Zone shall consist of 3 072 Physical Sectors from 192 ECC Blocks. The content of the 16 Physical Sectors of each ECC Block is repeated 192 times, unless specified otherwise. The structure of a Control Data Block shall be as shown in Figure 24.

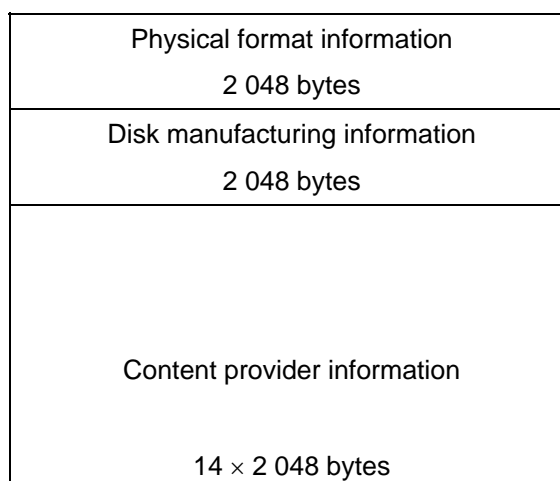

Figure 24 - Structure of a Control Data Block

17.11.1 Physical format information

This information shall comprise the 2 048 bytes shown in Table 15. It contains disk and format information.

Table 16 - Physical format information

Byte number	Content	Number of bytes
0	Disk Category and Version Number	1
1	Disk size	1
2	Disk structure	1
3	Recording density	1
4 to 15	Data Zone allocation	12
16	General Flag bits	1
17	Disk Application Code	1
18	Extended Information Indicators	1
19 to 26	Disk Manufacturer ID	8
27 to 29	Media Type ID	3
30	Product revision number	1

Table 17 - Physical format information (concluded)

Byte number	Content	Number of bytes
31	number of Physical format information bytes in use in ADIP up to byte 63	1
32 to 63	Basic write strategy parameters	32
64 to 95	Extended Information block 0	32
96 to 127	Extended Information block 1	32
128 to 159	Extended Information block 2	32
160 to 191	Extended Information block 3	32
192 to 223	Extended Information block 4	32
224 to 255	Extended Information block 5	32
256 to 2 047	Reserved - All (00)	1792

The information in bytes 0 to 255 are copied from the ADIP auxiliary data during initialization of the disk and may be modified during use to reflect the actual status of the disk (e.g. the actual end of the Data Zone). All 256 bytes have the same definitions and shall have the same contents as the Physical format information defined in Table 3 and 14.4.2, except the following bytes:

Byte 1 - Disk size and maximum transfer rate

Bits b_7 to b_4 same as 14.4.2

Bits b_3 to b_0 shall specify the maximum read transfer rate.

These bits may be set to one of the following values (depending on the maximum read-out speed needed by the application):

0000: specify a maximum transfer rate of 2,52 Mbits/s (See note at 27.3)

0001: specify a maximum transfer rate of 5,04 Mbits/s (See note at 27.3)

0010: specify a maximum transfer rate of 10,08 Mbits/s

1111: specify no maximum transfer rate is specified.

All other combinations are reserved and shall not be used.

Bytes 4 to 15 - Data Zone allocation

Bytes 4 to 8 same as 14.4.2

Bytes 9 to 11 in the first 16 ECC Blocks of the Control Data Zone:
shall specify the Sector Number of the last Physical Sector of the Recorded part of the Data Zone,

in the remaining 176 ECC Blocks of the Control Data Zone:
shall all be set to the Sector Number of the last Physical Sector of the Recorded part of the Data Zone, or shall all be set to (26053F) to specify PSN 2 491 711 as the last possible Physical Sector of the Data Zone (see also Annex A).

Bytes 12 to 15 same as 14.4.2

Byte 16 – General Flag bits

Bit b_7 same as 14.4.2

Bit b_6 same as 14.4.2

Bit b_5 shall specify if Buffer Zone 2 in the Lead-in Zone contains VCPS related information,

shall be set to 0, indicating no VCPS related information is present in Buffer Zone 2,

shall be set to 1, indicating Buffer Zone 2 contains VCPS related information as defined in the VCPS System Description (see Annex N).

Bits b_4 to b_0 same as 14.4.2

Bytes 256 to 2 047 - Reserved - All (00)

All remaining bytes are reserved and shall be set to all (00).

17.11.2 Disk manufacturing information

This Ecma Standard does not specify the format and the content of these 2 048 bytes. They shall be ignored in interchange.

17.11.3 Content provider information

These 28 672 bytes shall be set to all (00).

Under no circumstance may data received from the host be recorded in this field.

Circumvention: *Recorders and recording drives shall be considered as circumvention devices when these are produced to record, or can easily be modified to record, in any manner, a user-defined number in this field.*

17.12 Buffer Zone 2

This recorded Zone shall consist of 512 Physical Sectors from 32 ECC Blocks. During use of the disk VCPS related information may be recorded to these 32 ECC Blocks, according to the specifications given in the VCPS System Description (see Annex N). If no VCPS related information is copied to these locations then the Main Data of the Data Frames in this Zone shall be set to all (00).

18 Data Zone

2 295 104 Physical Sectors of user data area (see also Annex A).

The start radius of the Data Zone is determined by the location of Physical ADIP Address (00C000) and the maximum end radius is determined by the location of Physical ADIP Address (098150) (see 14.4.1.1, bit 2 to 23 and 13.7.1)

19 Lead-out Zone

The Lead-out Zone is the outermost zone of the Information Zone. It shall consist of the parts specified in Figure 25.

The Physical Sector Number of the first and the last Physical Sector of each part is indicated in Figure 25 in hexadecimal and decimal notation and the number of Physical Sectors in each part is indicated in decimal notation (see also Annex A).

19.1 Buffer Zone 3

This recorded Zone shall consist of 768 Physical Sectors. The start location of Buffer Zone 3 is (260540) (see also Annex A). The Main Data of the Data Frames in this Zone shall be set to all (00).

19.2 Outer Disk Identification Zone

256 Physical Sectors reserved for information agreed upon by the data interchange parties. Each set of 16 Physical Sectors from one ECC Block is either a Disk Control Block (DCB) (see Clause 22) or recorded with all (00) Main Data. The contents of this Zone shall be equivalent to the contents of the Inner Disk Identification Zone.

19.3 Guard Zone 2

This Guard Zone is used as a protection for separating test writing zones from information zones containing user data. This Zone shall be filled with Main Data set to (00). This zone shall contain 4 096 Physical Sectors.

---	Data Zone	---
Physical Sector 2 491 712	Buffer Zone 3 768 Physical Sectors with Main Data set to (00)	Physical Sector (260540)
Physical Sector 2 492 479 Physical Sector 2 492 480	Outer Disk Identification Zone 256 Physical Sectors	Physical Sector (26083F) Physical Sector (260840)
Physical Sector 2 492 735 Physical Sector 2 492 736	Guard Zone 2 4 096 Physical Sectors with Main Data set to (00)	Physical Sector (26093F) Physical Sector (260940)
Physical Sector 2 496 831 Physical Sector 2 496 832	Reserved Zone 4 4 096 Physical Sectors with Main Data set to (00)	Physical Sector (26193F) Physical Sector (261940)
Physical Sector 2 500 927 Physical Sector 2 500 928	Outer Drive Test Zone 12 288 Physical Sectors	Physical Sector (26293F) Physical Sector (262940)
Physical Sector 2 513 215 Physical Sector 2 513 216	Outer Disk Test Zone 2 048 Physical Sectors	Physical Sector (26593F) Physical Sector (265940)
Physical Sector 2 515 263 Physical Sector 2 515 264	Guard Zone 3 nominal 24 400 Physical Sectors with Main Data set to (00)	Physical Sector (26613F) Physical Sector (266140)
Physical Sector 2 539 663		Physical Sector (26C08F)

Figure 25- Lead-out Zone

19.4 Reserved Zone 4

4 096 Physical Sectors are reserved and shall be set all (00).

19.5 Outer Drive Test Zone

12 288 Physical Sectors reserved for drive testing and OPC algorithm.

19.6 Outer Disk Test Zone

2 048 Physical Sectors reserved for disk manufacturer testing.

19.7 Guard Zone 3

This Zone shall be filled with Main Data set to (00). This zone shall contain 24 400 Physical Sectors.

20 Assignment of Logical Sector Numbers (LSNs)

Logical Sector Numbers (LSNs) shall be assigned contiguously increasing by one from LSN 0, starting from the first PSN (030000) to the end of the Data Zone (see also Annex J).

21 Formatting

The disk shall be considered fully formatted if all areas in the Information Zone have been recorded. The Main data bytes in the ECC blocks can contain relevant data or can be set to dummy data (all bytes (00)). All ECC blocks, including those with dummy data, shall comply with Clause 13.

The disk shall be considered partially formatted if at least the Inner Disk Test Zone, the Inner Drive Test Zone, the Guard Zone 1, the Reserved Zone 1, the Reserved Zone 2, the Inner Disk

Identification Zone, the Reserved Zone 3, the Reference Code Zone, the Buffer Zone 1, the Control Data Zone and the Buffer Zone 2 in the Lead-in Zone have been recorded.

To indicate the status of the disk, the Disk Identification Zones shall contain a Formatting Disk Control Block (FDCB) (see 22.2).

NOTE

To enable data retrieval by Read-Only drives, the disk shall be formatted or recorded sequentially.

Formatting can be done in two different ways:

- 1) **Pre-formatting**, which is the conventional way of formatting used for many storage media. After the pre-formatting process, the disk is fully formatted. User Data shall not be recorded to the disk until the pre-formatting process is complete.

This process consists of the following steps:

- write Lead-in Zone
- write Data Zone
- write Lead-out Zone
- verify the Data Zone (optional)

- 2) **Background formatting**, which is a formatting process that runs in the background during use of the disk on a recorder. After the Background formatting process, the disk is fully formatted. User Data may be recorded to the disk during the Background formatting process. The disk may be interchanged at any time after the first step.

This process consists of the following steps:

- Initialization
- De-icing
- Finalization
- Verification

Initialization shall always be applied to a maiden disk, while the other steps are optional.

A third way of using the disk is

- 3) **Sequential recording without formatting**, where the disk is recorded by appending data to the end of the Data Zone.

21.1 Pre-formatting

If Pre-formatting is applied, this shall be done before any User Data is recorded onto the disk. The Inner Disk Identification Zone and the Outer Disk Identification Zone shall contain an FDCB according to 22.2 indicating pre-formatting in progress.

All other Zones shall be recorded according to Clause 17, 18 and 19.

After fully formatting the disk and before ejecting the disk, the drive shall update the FDCB.

21.1.1 Verification

Optionally the Data Zone can be certified. During this process every ECC Block in the Data Zone is checked for correctness.

21.2 Background formatting

Because the Pre-formatting process can be rather time consuming, and the user may want to use a blank disk immediately, Background formatting can be used instead of Pre-formatting. During the Background formatting process only a minimum amount of data will be recorded onto the disk, after which the disk can be used by the application. A disk on which a Background formatting process is active, may be formatted further by the recorder in the background during the moments that the application is not accessing the disk. Recording of User Data into previously unrecorded areas shall be considered formatting of that area.

21.2.1 Initialization

It is recommended that the Background formatting process starts with recording the Inner Disk Test Zone, the Inner Drive Test Zone, the Guard Zone 1, the Reserved Zone 1, the Reserved Zone 2, the Inner Disk Identification Zone, the Reserved Zone 3, the Reference Code Zone, the Buffer Zone 1, the Control Data Zone and the Buffer Zone 2 in the Lead-in Zone (see Table 15). In any case, these areas shall be recorded before the disk is ejected.

The Inner Disk Identification Zone shall contain an FDCB according to the definitions in 22.2. All other Zones shall be recorded according to Clause 17.

Optionally the Buffer Zone 3, the Outer Disk Identification Zone, and the Guard Zone 2 in the Lead-out Zone can be recorded.

After initialization the disk can be released for the application.

21.2.2 De-icing

De-icing is the process of recording all ECC blocks in the Data Zone. During the de-icing phase, unrecorded areas in the Data Zone shall be filled with ECC blocks containing all (00) bytes or with User Data when requested. When the de-icing process is activated on a partially formatted disk with a Temporary Lead-out, the Temporary Lead-out shall be overwritten with ECC blocks with bits b_{27} to b_{26} in the ID field of the Data Frames set to ZERO ZERO, indicating Data Zone (see 21.3).

All recorded areas shall be registered in the Formatting bitmap of a Formatting Disk Control Block (FDCB) in the Inner (and Outer) Disk Identification Zone. During the time intervals when the drive is idle, the De-icing process, controlled by the drive, can proceed in the background. When the application requests disk access, the De-icing process is suspended and the control of the disk is returned to the application. Application requested writes to previously unrecorded areas shall be registered in the FDCB. During background De-icing the drive should keep the FDCB updated. When an eject is requested during background De-icing, the drive may add a Temporary Lead-out Zone immediately following the last written ECC Block in the Data Zone (no unrecorded areas shall be present between the Lead-in Zone and such Temporary Lead-out Zone) according to the rules in 21.3 and the drive shall update the FDCB before ejecting the disk.

21.2.3 Finalization

When the De-icing process has finished and all areas in the Data Zone have been recorded, the drive shall add the Lead-out Zone according to Clause 19.

The Outer Disk Identification Zone shall contain the same DCBs as the Inner Disk Identification Zone (see Clause 22).

The Lead-in Zone shall be finished by adding the Initial Zone according to Clause 17.

21.2.4 Verification (optional)

Verification is the process of reading and checking all ECC blocks in the Data Zone. If an ECC block is found unreliable, this block can be replaced using a Defect Management system.

The Last Verified Address (LVA) pointer in the Formatting Disk Control Block (FDCB) in the Inner and Outer Disk Identification Zone shall register the area that has been checked. During the time intervals when the disk is idle, the Verification process, controlled by the drive, can proceed in the background. When the application requests disk access, the Verification process is suspended and the control of the disk is returned to the application. During background Verification the drive should keep the FDCB updated. When an eject is requested during background Verification, the drive shall update the FDCB before ejecting the disk.

21.3 Sequential recording without formatting

If the disk is used for contiguously sequential recording only, a Temporary Lead-out Zone immediately following the last recorded User Data should be recorded before ejecting the disk. The application can write additional data to the disk by overwriting the Temporary Lead-out Zone with User Data immediately followed by a new Temporary Lead-out Zone.

The Formatting status in the FDCB (see 22.2) shall be set to “partially formatted”, the Last Written Address shall be set to the last PSN of the last contiguously recorded ECC Block in the Data Zone, and the Formatting Bitmap shall not be used. All other bits shall be set to their relevant meaning.

The Temporary Lead-out Zone shall fulfil the following rules:

- Bits b_{27} to b_{26} in the ID field of the Data Frames in the Temporary Lead-out Zone shall be set to ONE ZERO, indicating Lead-out Zone.
- The length of the Temporary Lead-out Zone shall be at least 64 ECC Blocks, or the rules as given in Table 18 should be followed (see ECMA-267). (see also Annex A)

Table 18

Length of the Recorded part of the Data Zone (end radius)	End of the Temporary Lead-out Zone (radius)
less than 34,0 mm	35,0 mm min.
34,0 mm to 57,5 mm	end radius Data Zone + 1,0 mm min.
57,5 to 58,0 mm	58,5 mm

- The Temporary Lead-out Zone should be filled with all Main Data (00).
- Optionally, the 49th till the 64th ECC Block in the Temporary Lead-out may contain a Temporary Outer Disk Identification Zone according to the definitions as given in 19.2.
- It is allowed to have an unrecorded area between the end of the Temporary Lead-out Zone and Buffer Zone 3 located at radius 58 mm.

22 Disk Control Blocks

Disk Control ECC Blocks are provided as a structure on the disk to include additional information for interchange between the data interchange parties. DCBs are recorded in the Inner and Outer Disk Identification Zones. All DCBs shall have the same format for the first 40 data bytes. A special DCB is defined to reflect the status of the formatting process and to hold some general information.

Each type of DCB (i.e. with some specific Content Descriptor other than (00000000), (FFFFFFFE) or (FFFFFFF)) shall occur only once in each of the Inner and Outer Disk Identification Zones.

22.1 General format of Disk Control Blocks

The Main Data of each Disk Control Block shall be according to Table 19.

Table 19 – General format of each Disk Control Block

Physical Sector of each DCB	Main Data BP	Description
0	D_0 to D_3	Content Descriptor
0	D_4 to D_7	Unknown Content Descriptor Actions
0	D_8 to D_{39}	Drive ID
0	D_{40} to $D_{2\ 047}$	Content Descriptor Specific
1 to 15	D_0 - $D_{2\ 047}$	Content Descriptor Specific

Bytes D₀ to D₃ - Content Descriptor

If set to (00000000)

the DCB is unused.

The Content Descriptor of all subsequent DCBs in this Inner or Outer Disk Identification Zone

shall be set to (00000000).

All remaining bytes, D₄ to D_{2 047} of Physical Sector 0 and D₀ to D_{2 047} of Physical Sector 1 to 15 in Table 19 shall be set to (00).

If set to (46444300)

this DCB shall be as defined in 22.2.

If set to (57444300)

this DCB shall be as defined in 22.3.

If set to (FFFFFFFE)

this DCB is bad and shall not be used.

If set to (FFFFFFF)

this DCB was previously used and is now available for reuse.

All remaining bytes, D₄ to D_{2 047} of Physical Sector 0 and D₀ to D_{2 047} of Physical Sector 1 to 15 in Table 19 shall be set to (00).

All other values for the Content Descriptor are reserved.

Each new DCB added to the Inner or the Outer Disk Identification Block shall be written at the first unused DCB (Content Descriptor = (00000000) or (FFFFFFF)).

Each DCB with a Content Descriptor not set to (00000000), (FFFFFFFE) or (FFFFFFF) in the Inner Disk Identification Zone shall have an identical DCB in the Outer Disk Identification Zone. The order of the DCBs in the Inner Disk Identification Zone is not necessarily the same as the order in the Outer Disk Identification Zone.

Bytes D₄ to D₇ - Unknown Content Descriptor Actions

These bits are provided to specify required actions when the content and use of the DCB are unknown to the drive (i.e. the content descriptor is not set to a known assigned value). These bytes form a field consisting of 32 individual bits.

Bits b₃₁ to b₄ Reserved,
these bits shall be set to all ZERO.

Bit b₃ DCB overwrite,
if set to ONE, modifying the current DCB shall not be allowed,
else it shall be set to ZERO.

Bit b₂ Formatting,
if set to ONE, reformatting of the disk shall not be allowed,
else it shall be set to ZERO.

Bit b₁ DCB read protect,
if set to ONE, the information in this DCB is meant for use by the drive only and shall not be transferred outside the drive,
else it shall be set ZERO.

Bit b₀ Data Zone write,
if set to ONE, recording shall not be allowed in the Data Zone,
else it shall be set to ZERO.

Bytes D₈ to D₃₉ Drive ID

Bytes D₈ to D₃₉ shall contain a unique descriptor, identifying the drive that has last written the DCB. The format of this unique drive identifier shall be as follows:

- Bytes D₈ to D₂₃ shall identify the manufacturer of the drive. This name shall be represented by characters from the G0 set + SPACE according to ECMA-43. Trailing bytes not used shall be set to (00).
- Bytes D₂₄ to D₃₅ shall identify the model name/type number of the drive. This model name/type number shall be represented by characters from the G0 set + SPACE according to ECMA-43. Trailing bytes not used shall be set to (00).
- Bytes D₃₆ to D₃₉ shall contain a unique serial number of the drive. The 4 bytes shall form one 32-bit binary number.

Bytes D₄₀ to D_{2 047} Content Descriptor Specific

Bytes specified by the format description for the DCB with the actual Content Descriptor value.

Physical Sector 1 to 15: Bytes D₀ to D_{2 047} Content Descriptor Specific

Bytes specified by the format description for the DCB with the actual Content Descriptor value.

22.2 Format of the Formatting DCB (FDCB)

Both the Inner and Outer Disk Identification Zone shall contain one DCB reflecting the status of the disk. The FDCB in the Inner and Outer Disk Identification Zones shall be identical and have the content as defined in Table 20.

Physical Sector 0 / bytes D₀ to D₃ – Content Descriptor

These bytes identify the Formatting DCB and shall be set to (46444300), representing the characters “FDC” and the version number 0.

Physical Sector 0 / bytes D₄ to D₇ – Unknown Content Descriptor Actions

Shall be set to (0000000D) indicating that if this DCB is not known to the system, the DCB shall not be overwritten, the disk shall not be reformatted, writing to the Data Zone shall not be allowed, while transferring the DCB information from the drive to the host computer is allowed.

Physical Sector 0 / bytes D₈ to D₃₉ – Drive ID

These bytes shall contain the drive ID as specified in 22.1.

Physical Sector 0 / bytes D₄₀ to D₄₃ – FDCB update count

These bytes shall specify the total number of update operations of the FDCB. This field shall be set to (00000000) during the creation of the FDCB, and shall be incremented by one each time the FDCB is re-written.

Table 20 – Format of the FDCB

Physical Sector of ECC block	Main Data byte position	Description	number of bytes
0	D ₀ to D ₃	Content Descriptor	4
0	D ₄ to D ₇	Unknown Content Descriptor Actions	4
0	D ₈ to D ₃₉	Drive ID	32
0	D ₄₀ to D ₄₃	FDCB update count	4
0	D ₄₄ to D ₄₇	Formatting status and mode	4
0	D ₄₈ to D ₅₁	Last written address	4
0	D ₅₂ to D ₅₅	Last verified address	4
0	D ₅₆ to D ₅₉	Bitmap Start Address	4
0	D ₆₀ to D ₆₃	Bitmap Length	4
0	D ₆₄ to D ₉₅	Disk ID	32
0	D ₉₆ to D ₁₂₇	Application dependent	32
0	D ₁₂₈ to D ₁₉₁	List of DCBs	16×4
0	D ₁₉₂ to D _{2 047}	Reserved and set to (00)	1 856
1 to 9	D ₀ to D _{2 047}	Formatting bitmap	9×2 048
10 to 15	D ₀ to D _{2 047}	Reserved and set to (00)	6×2 048

Physical Sector 0 / byte D₄₄ to D₄₇ – Formatting status and mode

byte D₄₄ – Formatting status flags

bits 7 to 6	bit 5	bits 4 to 0
Formatting status	Formatting open	Reserved

bits 7 to 6:

- ZERO ZERO = disk is not formatted
- ZERO ONE = disk has been partially formatted
- ONE ZERO = disk has been fully formatted by user
- ONE ONE = disk has been fully formatted by manufacturer

bit 5:

- ZERO = the FDCB on the disk reflects the actual status of the disk
- ONE = the Formatting process of the drive is active and the FDCB on the disk might not reflect the actual status of the disk

bits 4 to 0: reserved

byte D₄₅ – Verification status flags

bits 7 to 6	bits 5 to 0
Verification status	Reserved

bits 7 to 6:

- ZERO ZERO = disk is not verified
- ZERO ONE = disk has been partially verified
- ONE ZERO = disk has been fully verified by user
- ONE ONE = disk has been fully verified by manufacturer

bits 5 to 0: reserved

byte D₄₆ – Recording status flags

bit 7	bits 6 to 5	bits 4 to 0
Lead-in status	Lead-out status	reserved

bit 7:

- ZERO = Lead-in is recorded from address (02A480) to address (02FFFF)
- ONE = Lead-in is fully recorded

bits 6 to 5:

- ZERO ZERO = No Lead-out has been recorded
- ZERO ONE = Temporary Lead-out has been recorded
- ONE ZERO = Lead-out is recorded from address (260540) to address (26193F) (see Clause 19 and 21.2.1) (see also Annex A)
- ONE ONE = Lead-out is fully recorded adjoining the actual last sector of the Data Zone

bits 4 to 0: reserved

byte D₄₇ – Reserved

set to (00)

Physical Sector 0 / bytes D₄₈ to D₅₁ – Last Written Address (LWA)

These 4 bytes shall indicate the last PSN of the last ECC Block of the contiguously recorded part of the Data Zone (not including any type of Lead-out Zone) starting from address (030000). (There shall be no unrecorded ECC Blocks between address (030000) and the LWA.) As long as the first ECC Block of the Data Zone is unrecorded, the LWA shall be set to (00000000), indicating that the LWA is not (yet) in use.

NOTE

some older drives might set the LWA to (0002FFFF) or (00030000) in case the first ECC Block is still unrecorded. Such a setting should be interpreted the same as (00000000).

After formatting has been finished, the LWA may also be set to (00000000).

Physical Sector 0 / bytes D₅₂ to D₅₅ – Last Verified Address (LVA)

These 4 bytes shall indicate the last PSN of the last ECC Block of the contiguously verified part of the Data Zone starting from address (030000). If not in use the LVA may also be set to (00000000).

Physical Sector 0 / bytes D₅₆ to D₅₉ – Bitmap Start Address (BSA)

These 4 bytes shall indicate the first PSN of the first ECC Block represented in the Formatting bitmap. This value shall be \geq (00030000) and less than the Last Written Address. They shall be set to (00000000) if the disk is fully Formatted or if the Formatting Bitmap is not used.

Physical Sector 0 / bytes D₆₀ to D₆₃ – Bitmap Length

These 4 bytes shall indicate the number of ECC Blocks represented in the Formatting bitmap. They shall be set to (00000000) if the disk is fully Formatted or if the Formatting Bitmap is not used.

Physical Sector 0 / bytes D₆₄ to D₉₅ – Disk ID

These 32 bytes shall be recorded with a random, statistically unique, 256-bit binary number at initialization of the disk.

Physical Sector 0 / bytes D₉₆ to D₁₂₇ – Application dependent

This field shall consist of 32 bytes and is reserved for use by the application to store information such as specific copy protection data. If this setting is not specified by the application, the bytes shall be set to (00).

Physical Sector 0 / bytes D₁₂₈ to D₁₉₁ – List of DCBs

To improve the robustness and the time to access the actually valid DCBs, it is recommended to store a list representing the 16 locations of the Inner/Outer Disk Identification Zone with the Content Descriptor of the DCB contained in each of these locations. This list shall be formatted according to Table 21.

Table 21 – Format of the List of DCBs

Physical Sector of ECC block	Main Data byte position	Description	number of bytes
0	D ₁₂₈ to D ₁₃₁	Content Descriptor of DCB in location 0	4
0	D ₁₃₂ to D ₁₃₅	Content Descriptor of DCB in location 1	4
0	:	:	:
0	D _(128+i×4) to D _(131+i×4)	Content Descriptor of DCB in location <i>i</i>	4
0	:	:	:
0	D ₁₈₈ to D ₁₉₁	Content Descriptor of DCB in location 15	4

bytes D_(128+i×4) to D_(131+i×4) – Content Descriptor of DCB in location *i*

Each group of 4 bytes shall represent the Content Descriptor (see 22.1, bytes D₀ to D₃) of the DCB in the specified location in the Disk Identification Zone (Inner or Outer) holding this FDCB.

Location *i* in the Inner Disk Identification Zone shall be the ECC Block starting with PSN (02EEC0) + *i*×16.

Location *i* in the Outer Disk Identification Zone shall be the ECC Block starting with PSN (260840) + *i*×16.

The List of DCBs shall include the FDCB itself. The position of the FDCB is not restricted to location 0.

If not used the List of DCBs shall be set to all (00000000).

NOTE

older drives might not be able to maintain the information in the List of DCBs accurately.

Physical Sector 0 / bytes D₁₉₂ to D_{2 047} – Reserved

These bytes are reserved and shall be set to (00).

Physical Sector 1 to 9 / bytes D₀ to D_{2 047} – Formatting bitmap

Physical Sectors 1 to 9 of the FDCB contain a bitmap, where each bit reflects the recording status of one ECC block. Bit 0 (the lsb) of Main Data byte D₀ of Sector 1 represents the first ECC block, indicated by the Bitmap Start Address, bit 1 of Main Data byte D₀ of Sector 1 represents the next ECC block, following the ECC Block indicated by the Bitmap Start Address, etc. All remaining bits in Physical Sectors 1 to 9 following the bitmap shall be set to ZERO.

The ECC blocks in the bitmap are identified by a sequence number i , where i starts at 0 for the ECC block at the Bitmap Start Address. Bit n of Main Data byte D _{m} of Sector k represents the i^{th} ECC block from the Bitmap Start Address:

$$i = [(k-1) \times 2\,048 + m] \times 8 + n, \text{ where } k = 1 \dots 9, m = 0 \dots 2\,047, n = 0 \dots 7$$

Address of the first Physical Sector of the i^{th} ECC block = Bitmap Start Address + $i \times 16$.

If the bit representing the i^{th} ECC block is set to ONE, then the i^{th} ECC block has not been recorded.

If the bit representing the i^{th} ECC block is set to ZERO, then the i^{th} ECC block has been recorded.

Physical Sector 10 to 15 / bytes D₀ to D_{2 047} – Reserved

All bytes in these sectors shall be set to (00)

22.3 Format of the Write inhibit DCB (WDCB)

Both the Inner and Outer Disk Identification Zone may optionally contain a DCB reflecting the write protect status of the disk. The WDCB in the Inner and Outer Disk Identification Zones shall be identical and have the content as defined in Table 22.

Table 22 – Format of the WDCB

Physical Sector of ECC block	Main Data byte position	Description	number of bytes
0	D ₀ to D ₃	Content Descriptor	4
0	D ₄ to D ₇	Unknown Content Descriptor Actions	4
0	D ₈ to D ₃₉	Drive ID	32
0	D ₄₀ to D ₄₃	WDCB update count	4
0	D ₄₄ to D ₄₇	Write protect Actions	4
0	D ₄₈ to D ₆₃	Reserved and set to (00)	16
0	D ₆₄ to D ₉₅	WDCB Password	32
0	D ₉₆ to D _{2 047}	Reserved and set to (00)	1 952
1 to 15	D ₀ to D _{2 047}	Reserved and set to (00)	15 × 2 048

Physical Sector 0 / bytes D₀ to D₃ – Content Descriptor

These bytes identify the Write inhibit DCB and shall be set to (57444300), representing the characters “WDC” and the version number 0.

Physical Sector 0 / bytes D₄ to D₇ – Unknown Content Descriptor Actions

Shall be set to (0000000F) indicating that if this DCB is not known to the system, the DCB shall not be overwritten, the disk shall not be reformatted, writing to the Data Zone shall not be allowed, and transferring the DCB information from the drive to the host computer shall not be allowed.

Physical Sector 0 / bytes D₈ to D₃₉ – Drive ID

these bytes shall contain the drive ID as specified in 22.1.

Physical Sector 0 / bytes D₄₀ to D₄₃ – WDCB update count

These bytes shall specify the total number of update operations of the WDCB. This field shall be set to (00000000) during the creation of the WDCB, and shall be incremented by one each time the WDCB is re-written.

Physical Sector 0 / byte D₄₄ to D₄₇ – Write protect Actions

These bits are provided to specify allowed and required actions. These bytes form a field consisting of 32 individual bits.

Bits b₃₁ to b₈ Reserved,
these bits shall be set to all ZERO.

Bit b₇ Write protect Change,
if set to ZERO, the Write protect Status bits b₆ to b₀ may be modified,
if set to ONE and the password received from the host is the same as the WDCB Password in this DCB, the Write protect Status bits b₆ to b₀ may be modified,
if set to ONE and the password received from the host is the different from the WDCB Password in this DCB, the Write protect Status bits b₆ to b₀ shall not be modified.

Bits b₆ to b₂ Reserved,
these bits shall be set to all ZERO.

Bits b₁, b₀ Write protect Status,
if set to ONE/ONE recording in any area on the disk shall not be allowed,
if set to ONE/ZERO recording in the actual User Data Area defined by an applied Defect Management System shall not be allowed,
if set to ZERO/ONE recording in the Data Zone on the disk (all of the area between the end of the Lead-in Zone and the start of the Lead-out Zone) shall not be allowed,
if set to ZERO/ZERO recording in all areas on the disk is allowed.

NOTE

the "User Data Area" is the part of the Data Zone meant for storing the User Data in case a Defect Management System is applied. This means that possible Sparing and Table Areas of a Defect Management System located in the Data Zone of the disk can be excluded from the write inhibition, in which case the Defect Management System can stay enabled.

Physical Sector 0 / bytes D₄₈ to D₆₃ – Reserved

These bytes are reserved and shall be set to (00)

Physical Sector 0 / byte D₆₄ to D₉₅ – WDCB Password

These bytes shall contain a user defined password consisting of up to 32 characters from the G0 set + SPACE according to ECMA-43. Trailing bytes not used shall be set to (00).

If all bytes of the WDCB Password field are set to (00), then all 32 bits of the Write protect Actions field shall be set to ZERO.

If the WDCB Password field is set to all (FF), then the disk is permanently write protected and further recording on the disk shall not be allowed. Bits b₇, b₁ and b₀ of the Write protect Actions field shall be set to ONE.

Physical Sector 0 / bytes D₉₆ to D_{2 047} – Reserved

These bytes are reserved and shall be set to (00)

Physical Sector 1 to 15 / bytes D₀ to D_{2 047} – Reserved

All bytes in these sectors shall be set to (00)

Section 5 - Characteristics of the groove

23 General

All recordings shall occur only in grooved areas. The groove centreline is deviated from the average track centreline with a phase modulated sinewave. Physical addressing information can be decoded from this phase modulated wobble.

The format of the groove information on the disk is defined in 14.4. Clause 25 specifies the requirements for the signals from grooves, as obtained when using the Reference Drive as defined in Clause 9.

24 Method of testing

24.1 Environment

All signals in Clause 25 shall be within their specified ranges with the disk in the test environment conditions defined in 8.1.1.

24.2 Reference Drive

All signals specified in Clause 25 shall be measured in the indicated channels of the Reference Drive as defined in Clause 9. The drive shall have the following characteristics for the purpose of these tests.

24.2.1 Optics and mechanics

The focused optical beam shall have the properties defined in 9.2 a) to i). The disk shall rotate as specified in 9.5.

24.2.2 Read power

The optical power incident on the read-out surface of the disk (used for reading the information) shall be $0,7 \text{ mW} \pm 0,1 \text{ mW}$.

24.2.3 Read channels

The drive shall have two read channels. Read Channel 1 gives a signal $(I_1 + I_2)$ related to the total amount of light in the exit pupil of the objective lens. Read Channel 2 gives a signal $(I_1 - I_2)$ related to the difference in the amount of light in the two halves of the exit pupil of the objective lens. These channels can be implemented as given in Clause 9.

For measurement of the push-pull and track cross signals, the read channel signals shall be filtered by a 1st order LPF with a $f_c(-3 \text{ dB})$ of 30 kHz.

For measurement of the wobble signal, the read channel signals shall be filtered by a 1st order Band Pass Filter with frequency range (-3 db): 25 kHz, slope +20 dB/decade to 4,0 MHz, slope -20 dB/decade.

24.2.4 Tracking

During the measurement of the signals, the axial tracking error between the focus of the optical beam and the recording layer shall not exceed $0,20 \mu\text{m}$;

the radial tracking error between the focus of the optical beam and the centre of a track shall not exceed $0,022 \mu\text{m}$

24.3 Definition of signals

All signals are linearly related to currents through a photo detector, and are therefore linearly related to the optical power falling on the detector.

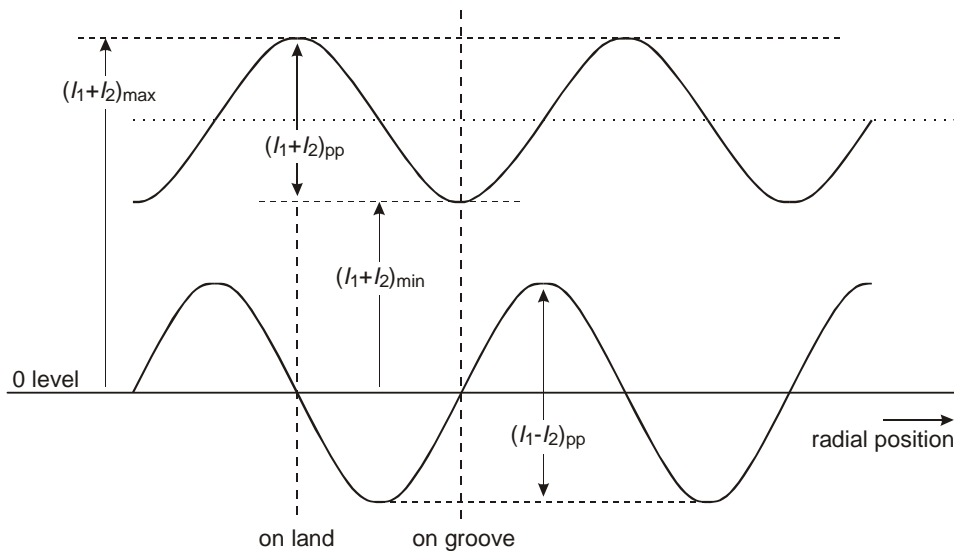

Figure 26 - Signals from grooves in the Read Channels when crossing the tracks

Push-pull signal

The push-pull signal is the filtered sinusoidal difference signal $(I_1 - I_2)$ in Read Channel 2, when the focus of the optical beam crosses the tracks. The signal can be used by the drive for radial tracking.

Track cross signal

The track cross signal is the filtered sinusoidal sum signal $(I_1 + I_2)$ in Read Channel 1, when the focus of the optical beam crosses the tracks.

Wobble signal

The wobble signal I_W is the filtered sinusoidal difference signal $(I_1 - I_2)$ in Read Channel 2, while the drive meets the minimum tracking requirement.

25 Characteristics of the groove signals

25.1 Phase depth

The phase depth of the groove shall not exceed 90°.

25.2 Push-pull signal

The peak-to-peak value of the push-pull signal PP shall meet the following requirements:

$$\text{a) before recording: } 0,28 \leq \frac{(I_1 - I_2)_{pp}}{[(I_1 + I_2)_{max} + (I_1 + I_2)_{min}]/2} \leq 0,56$$

The maximum variation of the push-pull signal before recording shall be: $\frac{PP_{max} - PP_{min}}{PP_{max} + PP_{min}} < 0,15$

$$\text{b) after recording: } 0,25 \leq \frac{(I_1 - I_2)_{pp}}{[(I_1 + I_2)_{max} + (I_1 + I_2)_{min}]/2} \leq 0,56$$

c) Ratio of push-pull signal of unrecorded groove to push-pull signal of recorded groove shall be in the range of 0,75 to 1,25.

25.3 Track Cross signal

The Track Cross signal for the unrecorded disk shall meet the following requirement:

The $(I_1 + I_2)_{min}$ value shall be generated at the groove centre.

25.4 Normalized wobble signal

The deviation from the track centreline shall be measured by the normalized wobble signal. The amount of distance that the centre of the wobble groove deviates from the average track centreline can be calculated according to Annex K.

The wobble signal shall be measured in an empty track during the monotone wobble part, at locations where the amplitude is not enhanced due to the positive interference of the wobble from adjacent tracks.

The normalized wobble signal shall be

$$0,20 \leq \frac{I_{W,pp-min}}{(I_1 - I_2)_{pp}} \leq 0,30$$

At locations where the amplitude of the wobble signal is enhanced due to the positive interference of the wobble from adjacent tracks, the maximum wobble signal shall be

$$\frac{I_{W,pp-max}}{I_{W,pp-min}} \leq 2,6$$

25.5 Characteristics of the wobble

The average Narrow band SNR of the wobble signal before recording shall be greater than 45 dB. The measurement shall be made using a resolution bandwidth of 1 kHz.

The average Narrow band SNR of the wobble signal after recording shall be greater than 38 dB. The measurement shall be made using a resolution bandwidth of 1 kHz.

Section 6 - Characteristics of the recording layer

26 Method of testing

The format of the information on the disk is defined in Clause 13. Clause 27 specifies the requirements for the signals from grooves, as obtained when using the Reference Drive as defined in Clause 9.

This Clause specifies the average quality of the rewritable information. Local deviations from the specified values, called defects, can cause tracking errors or errors in the Data fields. These errors are covered by Clause 29 and section 7.

26.1 Environment

All signals in 27.2.2 to 27.2.6 shall be within their specified ranges with the disk in the test environment conditions defined in 8.1.1.

26.2 Reference Drive

All signals specified in 27.2.2 to 27.2.6 shall be measured in the indicated channels of the Reference Drive as defined in Clause 9. The drive shall have the following characteristics for the purpose of these tests.

26.2.1 Optics and mechanics

The focused optical beam shall have the properties defined in 9.2 a) to i). The disk shall rotate as specified in 9.5.

26.2.2 Read power

The optical power incident on the read-out surface of the disk (used for reading the information) shall be $0,7 \text{ mW} \pm 0,1 \text{ mW}$.

26.2.3 Read channels

The drive shall have two read channels. Read Channel 1 gives a signal ($I_1 + I_2$) related to the total amount of light in the exit pupil of the objective lens. Read Channel 2 gives a signal ($I_1 - I_2$) related to the difference in the amount of light in the two halves of the exit pupil of the objective lens. These channels can be implemented as given in Clause 9.

For measurement of the push-pull and track cross signals, the read channel signals shall be filtered by a 1st order LPF with a f_c (-3 dB) of 30 kHz.

The signal from Read channel 1 is not equalized except when measuring jitter. The threshold level for binarizing the read signal shall be controlled to minimize the effects of mark and space size changes due to parameter variations during writing. Jitter measurements shall be made using the Read Channel 1 with the characteristics in Annex E.

26.2.4 Tracking

During recording and during the measurement of the signals, the axial tracking error between the focus of the optical beam and the recording layer shall not exceed $0,20 \mu\text{m}$;

the radial tracking error between the focus of the optical beam and the centre of a track shall not exceed $0,022 \mu\text{m}$ when running at the Reference velocity and shall not exceed $0,045 \mu\text{m}$ when running at a higher velocity.

NOTE

At high recording or playback velocities, advanced servo systems might be needed to achieve tracking errors below these maximum values.

26.2.5 Scanning velocity

Write tests are performed at each of the recording velocities defined in 14.4.2 with its related write strategy.

All read tests are performed at the Reference velocity.

26.3 Write conditions

Marks and spaces are written on the disk by pulsing a laser.

26.3.1 Write pulse waveform

The laser power is modulated according to the write pulse waveform given in Annex G.

A 3T to 14T is written by applying a multiple-pulse train of write pulses.

The recording power has three levels: the Write power (P_w), the Erase power (P_e), and the Cooling power (P_c), which are the optical powers incident at the entrance surface of the disk and used for writing marks and spaces. The values of these power levels shall be optimized according to Annex I.

The actual recording powers, P_w , P_e , and P_c shall be within 5 % of their optimum values.

26.3.2 Write power

The optimized recording powers, P_{wo} , P_{eo} and P_{co} shall meet the following conditions

for the basic write strategy defined in 14.4.2.2:

$$8,0 \text{ mW} \leq P_{wo} \leq 16,0 \text{ mW}$$

$$3,0 \text{ mW} \leq P_{eo} \leq 9,0 \text{ mW}$$

$$0,1 \text{ mW} \leq P_{co} \leq 0,7 \text{ mW}$$

for the "4x" write strategy defined in 14.4.2.3.1:

$$11,0 \text{ mW} \leq P_{wo} \leq 22,0 \text{ mW}$$

$$3,0 \text{ mW} \leq P_{eo} \leq 11,0 \text{ mW}$$

$$0,1 \text{ mW} \leq P_{co} \leq 0,7 \text{ mW}$$

26.4 Measurement conditions

The test for jitter shall be carried out on any group of five adjacent tracks, designated ($m-2$), ($m-1$), m , ($m+1$), ($m+2$), in the Information Zone of the disk. The jitter shall be measured on recordings made at all velocities specified in 14.4.2.2, byte 32 and in the Extended Information blocks defined under 14.4.2.3.

For measurement of jitter, the system described in Annex E shall be used.

The Jitter shall be measured according to the following procedure:

Write random data on all five tracks 10 times each as specified in 26.3.1.

Read the data of track m under the conditions specified in 26.2.

27 Characteristics of the recorded signals

The following signals shall be measured, after recording with the write conditions as specified in 26.3.1.

27.1 Channel bit length

The average Channel bit length over each RUN shall be

$$133,3 \text{ nm} \pm 1,4 \text{ nm}$$

27.2 Definition of signals

All signals are linearly related to currents through a photo-diode detector, and are therefore linearly related to the optical power falling on the detector.

27.2.1 High frequency signals (HF)

The HF signal is obtained by summing the currents of the four elements of the photo detector as generated in Read Channel 1. These currents are modulated by the effects of the marks and spaces representing the information on the recording layer.

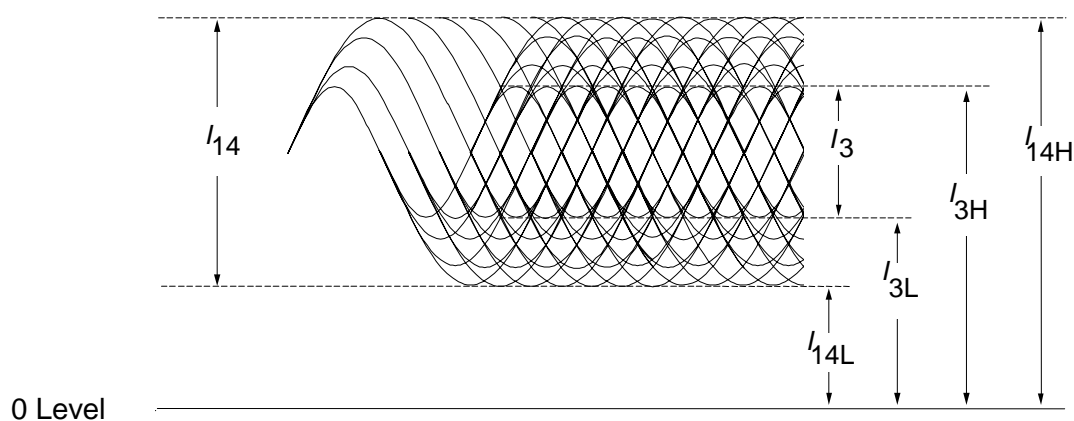

97-0002-A

Figure 27 -Signals from spaces and marks in Read channel 1

27.2.2 Modulated amplitude

The modulated amplitude l_{14} is the peak-to-peak value of the HF signal generated by the largest mark and space lengths (see Figure 27). The peak value l_{14H} shall be the peak value of the HF signal before a.c. coupling. The modulated amplitude l_3 is the peak-to-peak value generated by the shortest mark and space lengths. The 0 Level is the signal level obtained from the measuring device when no disk is inserted. These parameters shall meet the following requirements under all conditions, also such as a different number of overwrites, and when recordings have been made at different speeds.

$$\frac{l_{14}}{l_{14H}} \geq 0,60$$

$$\frac{l_3}{l_{14}} \geq 0,15$$

$$\text{Within one disk, } \frac{(l_{14H\max} - l_{14H\min})}{l_{14H\max}} \leq 0,25$$

$$\text{Within one revolution, } \frac{(l_{14H\max} - l_{14H\min})}{l_{14H\max}} \leq 0,15$$

27.2.3 Signal asymmetry

The signal asymmetry shall meet the following requirement:

$$-0,05 \leq \left[\frac{\frac{l_{14H} + l_{14L}}{2} - \frac{l_{3H} + l_{3L}}{2}}{l_{14}} \right] \leq +0,15$$

27.2.4 Normalized Slicing Level jump

Between any 2 consecutive ECC Blocks, the Normalized Slicing Level (NSL) jump shall be:

$$\left| \frac{(l_{3H,2} + l_{3L,2}) - (l_{3H,1} + l_{3L,1})}{(l_{3H,2} - l_{3L,2}) + (l_{3H,1} - l_{3L,1})} \right| \leq 0,50$$

where $l_{3H,1}$ and $l_{3L,1}$ are the l_3 levels just before the linking position
and $l_{3H,2}$ and $l_{3L,2}$ are the l_3 levels just after the linking position.

This requirement shall be fulfilled also after a different number of overwrites for the 2 ECC Blocks (up to 500 DOW cycles), and when the 2 ECC Blocks have been recorded at different speeds.

27.2.5 Jitter

Jitter is the standard deviation σ of the time variations of the binary read signal. This binary read signal is created by a slicer, after feeding the HF signal from the HF read channel through an equalizer and LPF (see Annex E). The jitter of the leading and trailing edges is measured relative to the PLL clock and normalized by the Channel bit clock period.

The jitter shall be measured at the Reference velocity using the circuit specified in Annex E.

The jitter measurement shall be using the conditions specified in 26.4.

The measured jitter shall not exceed 9,0 %.

27.2.6 Track Cross signal

The Track Cross signal is the filtered sinusoidal sum signal ($l_1 + l_2$) in Read Channel 1 when the focus of the optical beam crosses the tracks. The Track Cross signal shall meet the following requirement:

$$\frac{(l_1 + l_2)_{pp}}{(l_1 + l_2)_{max}} \geq 0,13$$

27.3 Read stability

When read with a read power of 0,8 mW at a temperature of 55 °C, all parameters specified in 27.2.2 to 27.2.6 shall be within their specified ranges after 1 000 000 repeated reads.

NOTE

Reading with the same read power at lower speeds than the reference speed might degrade the read stability.

28 Additional testing conditions

Recorded +RW disks compliant with this +RW Ecma Standard shall also fulfil the following basic signal specifications when measured with the Pick Up Head according to the ECMA-267 Standard.

28.1 Test environment

All conditions are the same as in 26.1 to 26.2.5. except for the following.

28.1.1 Optics

The focused optical beam used for reading data shall have the following properties:

- | | |
|--|--|
| a) Wavelength (λ) | 650 nm \pm 5 nm |
| b) Numerical aperture of the objective lens (NA) | 0,60 \pm 0,01 |
| c) The objective lens shall be compensated for spherical aberrations caused by a parallel substrate with nominal thickness (0,6 mm) and nominal refractive index (1,55). | |
| d) Wave front aberration | 0,033 \times λ rms max. |
| e) Light intensity at the rim of the pupil of the objective lens | 60 % to 70 % of the maximum intensity in the radial direction and over 90 % in the tangential direction. |
| f) Polarization of the light | Circular |
| g) Read power | 0,7 mW \pm 0,1 mW |
| h) Relative Intensity Noise (RIN)* of laser diode | -134 dB/Hz max. |

*RIN (dB/Hz) = 10 log [(a.c. light power density / Hz) / d.c. light power]

28.2 Definition of signals

For the definition of the following signals see 27.2 and the underlying subclauses.

28.2.1 Modulated amplitude

$$I_{14} / I_{14H} \geq 0,60$$

$$I_3 / I_{14} \geq 0,15$$

$$\text{Within one disk, } (I_{14H\max} - I_{14H\min}) / I_{14H\max} \leq 0,33 \text{ (with PBS)}$$

$$\text{Within one disk, } (I_{14H\max} - I_{14H\min}) / I_{14H\max} \leq 0,20 \text{ (without PBS)}$$

$$\text{Within one revolution, } (I_{14H\max} - I_{14H\min}) / I_{14H\max} \leq 0,15 \text{ (with PBS)}$$

$$\text{Within one revolution, } (I_{14H\max} - I_{14H\min}) / I_{14H\max} \leq 0,10 \text{ (without PBS)}$$

28.2.2 Signal asymmetry

$$-0,05 \leq \left[\frac{\frac{I_{14H} + I_{14L}}{2} - \frac{I_{3H} + I_{3L}}{2}}{I_{14}} \right] \leq +0,15$$

28.2.3 Jitter

The jitter shall be measured at the Reference velocity using the circuit specified in Annex E.

The jitter measurement shall be using the conditions specified in 26.4.

The measured jitter shall not exceed 9,0 %.

28.2.4 Track Cross signal

$$\frac{(I_1 + I_2)_{pp}}{(I_1 + I_2)_{max}} \geq 0,10$$

28.2.5 Differential phase tracking error signal

The output currents of the four quadrants of the split photo detector shown in Figure 28 are identified by I_a , I_b , I_c , and I_d .

The differential phase tracking error signal shall be derived from the phase differences between the sum of the currents of diagonal pairs of photo detector elements when the light beam crosses the tracks:

{Phase ($I_a + I_c$) – Phase ($I_b + I_d$)}, see Figure 29 and Annex F.

The phase difference signals shall be low-pass filtered with f_c (-3 db) of 30 kHz.

This differential phase tracking error signal shall meet the following requirements (see Figure 29):

Amplitude

At the positive 0 crossing $\overline{\Delta t}/T$ shall be in the range 0,50 to 1,10 at 0,10 μm radial offset, where $\overline{\Delta t}$ is the average time difference derived from the phase differences between the sum of the currents of diagonal pairs of photo detector elements, and T is the Channel bit clock period.

Asymmetry (see Figure 29)

The asymmetry shall meet the following requirement: $\frac{|T_1 - T_2|}{|T_1 + T_2|} \leq 0,20$

where T_1 is the positive peak value of $\overline{\Delta t}/T$
and T_2 is the negative peak value of $\overline{\Delta t}/T$

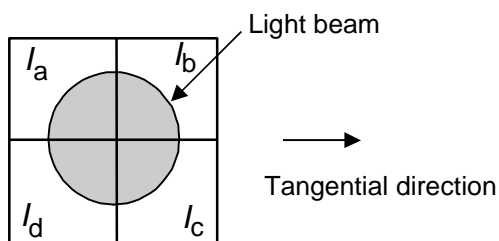

97-0047-A

Figure 28 - Quadrant photo detector

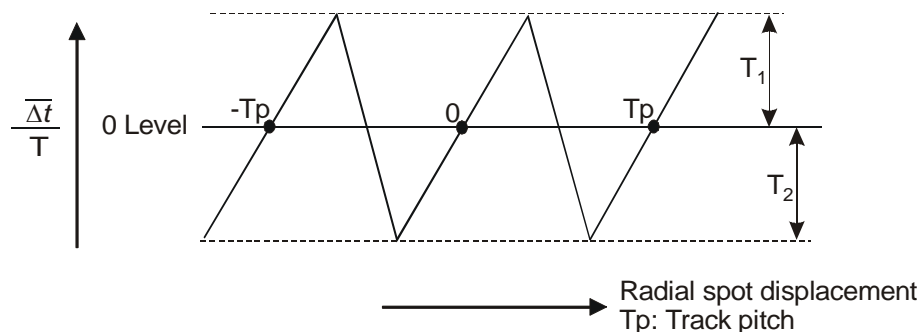

Figure 29 - Differential phase tracking error signal

28.2.6 Tangential push-pull signal

This signal shall be derived from the instantaneous level of the differential output $(I_a + I_d) - (I_b + I_c)$. It shall meet the following requirements, see Figure 30:

$$0 \leq \frac{[(I_a + I_d) - (I_b + I_c)]_{pp}}{I_{14}} \leq 0,9$$

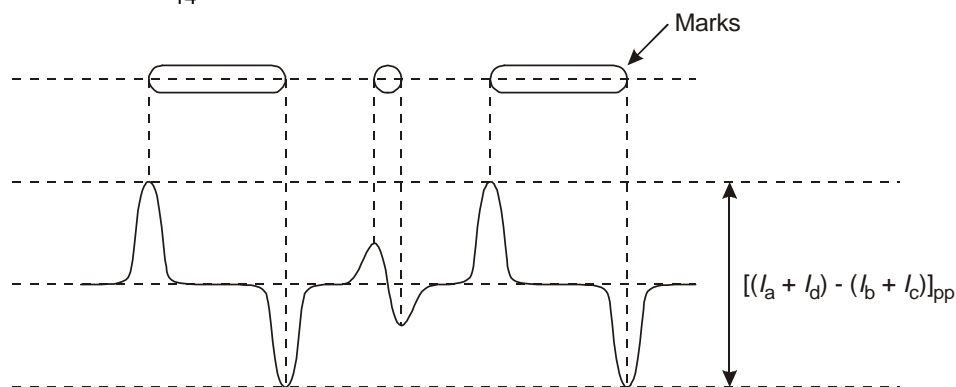

Figure 30 – Tangential push-pull signal

29 Quality of the recording layer

For the integrity of the data on the disk, the recording layer shall fulfil the following initial quality requirements.

29.1 Defects

Defects are air bubbles and black spots. Their diameter shall meet the following requirements:

- for air bubbles it shall not exceed 100 μm ,
- for black spots causing birefringence it shall not exceed 200 μm ,
- for black spots not causing birefringence it shall not exceed 300 μm .

In addition, over a distance of 80 mm in scanning direction of tracks, the following requirements shall be met:

- the total length of defects larger than 30 μm shall not exceed 300 μm ,
- there shall be at most 6 such defects.

29.2 Data errors

A byte error occurs when one or more bits in a byte have a wrong value, as compared to their original recorded value.

A row of an ECC Block as defined in 13.3 that has at least 1 byte in error constitutes a PI error.

If a row of an ECC Block as defined in 13.3 contains more than 5 erroneous bytes, the row is said to be “PI-uncorrectable”.

The disk shall be recorded with arbitrary data in one single uninterrupted writing action from the start of the Lead-in Zone until the end of the Lead-out Zone (“Disk-At-Once” mode).

During playback after the initial recording, the errors as detected by the error correction system shall meet the following requirements:

- in any 8 consecutive ECC Blocks the total number of PI errors before correction shall not exceed 280,
- in any ECC Block the number of PI-uncorrectable rows should not exceed 4.

Section 7 - Characteristics of user data

30 Method of testing

Clause 31 describes a series of measurements to test conformance of the user data on the disk with this Ecma Standard. It checks the legibility of the user-written data. The data is assumed to be arbitrary. The data may have been written by any drive in any operating environment (see 8.1.2). The read tests shall be performed on the Reference Drive as defined in Clause 9.

Whereas Clause 26 disregards defects, Clause 31 includes them as an unavoidable deterioration of the read signals. The severity of a defect is determined by the correctability of the ensuing errors by the error detection and correction circuit in the read channel defined below. The requirements in Clause 31 define a minimum quality of the data, necessary for data interchange.

30.1 Environment

All signals in 31.1 to 31.2 shall be within their specified ranges with the disk in any environment in the range of allowed operating environments defined in 8.1.2. It is recommended that before testing, the entrance surface of the disk shall be cleaned according to the instructions of the manufacturer of the disk.

30.2 Reference Drive

All signals specified in Clause 31 shall be measured in the indicated channels of the Reference Drive as defined in Clause 9. The drive shall have the following characteristics for the purpose of these tests:

30.2.1 Optics and mechanics

The focused optical beam shall have the properties already defined in 9.2 a) to i). The disk shall rotate as specified in 9.5.

30.2.2 Read power

The optical power incident on the entrance surface of the disk (used for reading the information) shall be $0,7 \text{ mW} \pm 0,1 \text{ mW}$.

30.2.3 Read channels

The drive shall have two read channels. Read Channel 1 gives a signal $(I_1 + I_2)$ related to the total amount of light in the exit pupil of the objective lens. Read Channel 2 gives a signal $(I_1 - I_2)$ related to the difference in the amount of light in the two halves of the exit pupil of the objective lens. These channels can be implemented as given in 9.3 and 9.6.

The signal from Read channel 1 is equalized and filtered before processing. The threshold level for binarizing the read signal shall be controlled to minimize the effects of mark and space size changes due to parameter variations during writing. For measurement of the disk quality as specified in Clause 31, the equalizer, filter and slicer, and the characteristics of the PLL shall be the same as specified in Annex E for the jitter measurement.

30.2.4 Error correction

Correction of errors in the data bytes shall be carried out by an error detection and correction system based on the definition in 13.3.

30.2.5 Tracking

During the measurement of the signals, the axial tracking error between the focus of the optical beam and the recording layer shall not exceed $0,20 \text{ }\mu\text{m}$;

the radial tracking error between the focus of the optical beam and the centre of a track shall not exceed $0,022 \text{ }\mu\text{m}$

31 Minimum quality of a Recording Unit

This Clause specifies the minimum quality of the data of a Recording Unit as required for data interchange. The quality shall be measured on the Reference Drive as defined in Clause 9 and Annex E.

A byte error occurs when one or more bits in a byte have a wrong value, as detected by the ECC and/or EDC circuits.

31.1 Tracking

The focus of the optical beam shall not jump tracks unintentionally.

31.2 User-written data

The user-written data in a Recording Unit as read in Read channel 1 shall not contain any byte errors that cannot be corrected by the error correction defined in 13.3. To relieve this requirement, a defect management system can be used, which autonomously replaces unreliable Recording Units (see Annex M).

Annex A (normative)

80 mm disk

The +RW Format also allows an 80 mm disk with capacities of 1,46 Gbytes and 2,92 Gbytes. All mechanical, physical and optical characteristics shall be equal to those of the 120 mm disks specified in this document, except for the following items:

see: **10.2 Overall dimensions**

The disk shall have an overall diameter $d_1 = 80,00 \text{ mm} \pm 0,30 \text{ mm}$

see: **10.7 Information Zone**

The Information Zone shall extend from diameter d_6 to diameter

$$d_7 = 77,5 \text{ mm min.}$$

This Zone consists of the Lead-in Zone, the Data Zone, and the Lead-out Zone.

see: **11.1 Mass**

The mass of the disk shall be in the range of 6,0 g to 9,0 g.

see: **11.2 Moment of inertia**

The moment of inertia of the disk, relative to its rotation axis, shall not exceed $0,010 \text{ g}\cdot\text{m}^2$.

see: **11.3 Dynamic Imbalance**

The dynamic imbalance of the disk, relative to its rotation axis, shall not exceed $1,5 \text{ g}\cdot\text{mm}$.

see: **14.1 Track shape**

The tracks shall be continuous in the Information Zone. The groove tracks shall start at a radius of 22,00 mm max. and end at a radius of 38,75 mm min.

see: **14.4.1.1 ADIP word structure, bits 2 to 23**

Physical ADIP Address (0379CC), which is the first address corresponding to the Lead-out Zone, shall be located at a radius $\leq 38,00 \text{ mm}$.

see: **14.4.2.1 General information – Bytes 0 to 31**

Byte 1 – Disk size and maximum transfer rate

Bits b_7 to b_4 shall specify the disk size, they shall be set to 0001, indicating a 80 mm disk.

Bytes 4 to 15 – Data Zone allocation

Bytes 9 to 11 shall be set to (0DE72F) to specify PSN 911 151 as the last possible Physical Sector of the Data Zone.

see: **16 Layout of the Information Zone**

Table A.1 – Layout of the Information Zone of a fully formatted disk

	Description	Nominal radius in mm	PSN of the first Physical Sector	Number of Physical Sectors
Lead-in	all the same as 120 mm disk	---	---	---
Data	Data Zone	start 24,000 mm	(030000)	714 544
Lead-out	Buffer Zone 3	start 38,000 mm	(0DE730)	768
	Outer Disk Identification Zone		(0DEA30)	256
	Guard Zone 2		(0DEB30)	4 096
	Reserved Zone 4	start 38,082 mm	(0DFB30)	4 096
	Outer Drive Test Zone		(0E0B30)	12 288
	Outer Disk Test Zone		(0E3B30)	2 048
	Guard Zone 3	start 38,375 mm end \geq 38,500 mm	(0E4330)	7 936 nominal

see: **17.11.1 Physical format information**

Bytes 4 to 15 – Data Zone allocation

Bytes 9 to 11 in the first 16 ECC Blocks of the Control Data Zone:
shall specify the Sector Number of the last Physical Sector of the Recorded part of the Data Zone.

in the remaining 176 ECC Blocks of the Control Data Zone:
shall all be set to the Sector Number of the last Physical Sector of the Recorded part of the Data Zone, or shall all be set to (0DE72F) to specify PSN 911 151 as the last possible Physical Sector of the Data Zone.

see: **18 Data Zone**

714 544 Physical Sectors of user data area.

The start radius of the Data Zone is determined by the location of Physical ADIP Address (00C000) and the maximum end radius is determined by the location of Physical ADIP Address (0379CC) (see 14.4.1.1, bit 2 to 23 and 13.7.1).

see: **19 Lead-out Zone**

Data Zone		
---		---
Physical Sector 911 152	Buffer Zone 3 768 Physical Sectors	Physical Sector (0DE730)
Physical Sector 911 919		Physical Sector (0DEA2F)
Physical Sector 911 920	Outer Disk Identification Zone 256 Physical Sectors	Physical Sector (0DEA30)
Physical Sector 912 175		Physical Sector (0DEB2F)
Physical Sector 912 176	Guard Zone 2 4 096 Physical Sectors with Main Data set to (00)	Physical Sector (0DEB30)
Physical Sector 916 271		Physical Sector (0DFB2F)
Physical Sector 916 272	Reserved Zone 4 4 096 Physical Sectors	Physical Sector (0DFB30)
Physical Sector 920 367		Physical Sector (0E0B2F)
Physical Sector 920 368	Outer Drive Test Zone 12 288 Physical Sectors	Physical Sector (0E0B30)
Physical Sector 932 655		Physical Sector (0E3B2F)
Physical Sector 932 656	Outer Disk Test Zone 2 048 Physical Sectors	Physical Sector (0E3B30)
Physical Sector 934 703		Physical Sector (0E432F)
Physical Sector 934 704	Guard Zone 3 7 936 Physical Sectors with Main Data set to (00)	Physical Sector (0E4330)
Physical Sector 942 639		Physical Sector (0E622F)

Figure A.1 – Lead-out Zone

see: **19.1 Buffer Zone 3**

The start location of Buffer Zone 3 is (0DE730).

see: **21.3 Sequential recording**

Table A.2

Length of the Recorded part of the Data Zone (end radius)	End of the Temporary Lead-out Zone (radius)
less than 34,0 mm	35,0 mm min.
34,0 mm to 37,5 mm	end radius Data Zone + 1,0 mm min.
37,5 to 38,0 mm	38,5 mm

It is allowed to have an unrecorded area between the end of the Temporary Lead-out Zone and Buffer Zone 3 located at radius 38 mm.

see: **22.2 Format of the FDCB**

Byte D₄₆ – Recording status flag

bit 6 to bit 5:

ZERO ZERO = No Lead-out has been recorded

ZERO ONE = Temporary Lead-out has been recorded

ONE ZERO = Lead-out is recorded from address (0DE730) to address (0DFB2F)
(see Clause 19 and 21.2.1)

ONE ONE = Lead-out is fully recorded



Annex B (normative)

Structure for Extended format information in the Data Zone

The ADIP Aux Frames in the Data Zone may be used to store information needed to support specific applications, such as e.g. encryption/decryption keys needed for a copy-protection system. This annex only specifies the general structure for such information.

B.1 Extended format information

The Extended Format Information consists of a table of contents (EFI TOC) and up to 16 distinct regions that contain additional format information. The EFI TOC defines the location and contents of the regions contained in the Extended Format Information, see B.1.1. The EFI TOC shall be stored in the ADIP Aux Frames (see 14.4.1.1) in the Data Zone, starting at the ADIP word that has Physical ADIP Address (00C000). The regions of the Extended Format Information shall be located in the ADIP Aux Frames in the Data Zone and/or shall be present as pre-recorded areas in the main data channel. Each region contains one or more copies of a data block of a particular type, as indicated in the EFI TOC.

Figure B.1 schematically shows an example lay-out, based on the VCPS copy-protection system, with the EFI TOC and the VCPS-defined regions that are contained in the ADIP Aux Frames in the Data Zone. The EFI TOC consists of 8 consecutive copies of an ETOC block, where each ETOC block contains the complete EFI TOC information (see B.1.1). The VCPS-defined hash region contains one or more copies of the DKB hash value, as specified in the EFI TOC. The VCPS-defined DKB region contains one or more copies of the DKB, as specified in the EFI TOC. Gaps may exist between any two regions. All bytes in the ADIP Aux Frames in the gaps shall be set to (00).

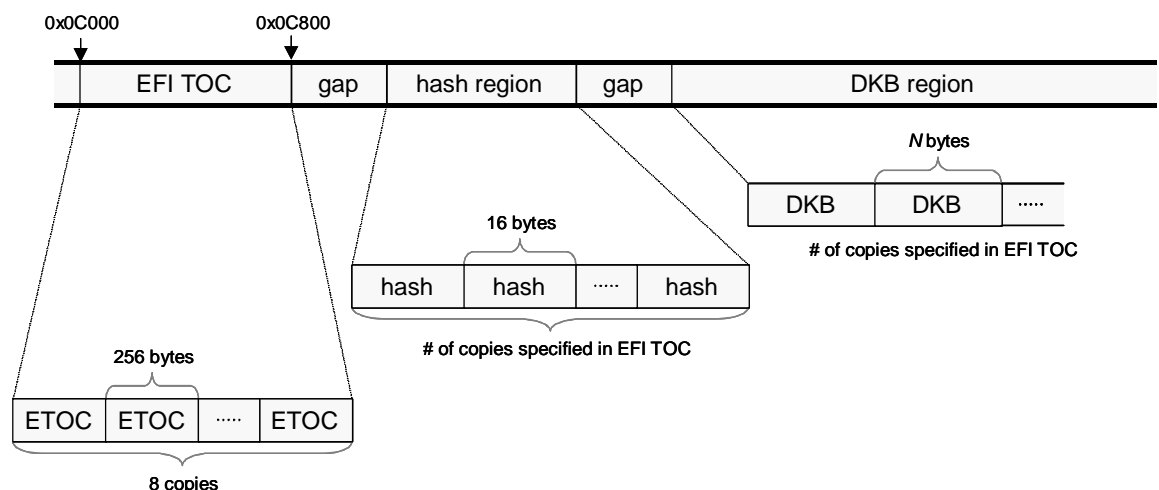

Figure B.1 – Example lay-out of Extended format information in ADIP

B.1.1 EFI TOC

The EFI TOC starts at the ADIP word that has Physical Address (00C000). The length of the EFI TOC is 8 ADIP Aux Frames, which is equivalent to 2048 consecutive ADIP words. As shown in Figure B.1, the EFI TOC consists of 8 consecutive copies of an ETOC block. The ETOC block consists of at most 16 Region Descriptors, as defined in Figure B.2. The combined size of all Region Descriptors contained in the ETOC block shall be no more than 256 bytes. Remaining bytes shall be set to all zeros, such that the size of the ETOC block is exactly 256 bytes.

Byte	Bit	7	6	5	4	3	2	1	0
0		Region Descriptor #1							
:									
:		Region Descriptor #2							
:									
:		:							
:		Region Descriptor #n							
:		(00)							
:		:							
255		(00)							

Figure B.2 – ETOC block

Region Descriptor #i: Region Descriptor #i contains information with respect to the i-th region of the Extended Format Information ($1 \leq i \leq n \leq 16$). A Region Descriptor consists of a Basic Region Descriptor followed by zero or more Extended Region Descriptors. The format of a Basic Region Descriptor is defined in Figure B.3. The format of an Extended Region Descriptor is defined in Figure B.4.

Byte	Bit	7	6	5	4	3	2	1	0
0		(msb)							
1		Region Type Identifier							
2		(lsb)							
3	Extent	Version number							
4	(msb)	Region Start Address							
5		(lsb)							
6	(msb)	Data Block Size							
:									
9		(lsb)							
10		Repeat Count							
11		Reserved							Private
12	(msb)	Alternative Location							
:									
15		(lsb)							

Figure B.3 – Basic Region Descriptor

Region Type Identifier: The type of the data block that is contained in the region. Data blocks stored in different regions having the same Region Type Identifier shall be identical.

Extent: The Extent bit shall indicate if this Basic Region Descriptor is followed by an Extended Region Descriptor, as follows:

- 0: This Basic Region Descriptor is not followed by an Extended Region Descriptor.
- 1: This Basic Region Descriptor is followed by an Extended Region Descriptor.

Version Number: The revision of the data block type that is contained in the region.

Region Start Address: If the data block is stored in the ADIP Aux Frames, the Region Start Address is given as the Physical ADIP Address of the ADIP word that contains the first byte of the data block, divided by 256. The Region Start Address shall be greater than or equal to (00C8). If the data block is not stored in the ADIP Aux Frames, the Region Start Address shall be zero. In that case the Alternative Location shall be non-zero and specify the location of the data block in the main data channel.

Data Block Size: The size in bytes of a single copy of the data block in the region. The Data Block Size shall be set to zero if the data block is not contained in the ADIP Aux Frames.

Repeat Count: The number of consecutive copies of the data block that are contained in the region. If the data block is stored in the ADIP Aux Frames and the region extends through the end of the Disk, Repeat Count shall be set to 0. The Repeat Count shall be set to zero if the data block is not contained in the ADIP Aux Frames.

Reserved: All reserved bits shall be set to '0'.

Private: The Private bit shall indicate if a Drive is permitted to output the contents of the region, as follows:

- 0: A Drive is permitted to output the contents of the region.
- 1: A Drive is not permitted to output the contents of the region.

Alternative Location: In addition to, or alternative to storage in the ADIP Aux Frames, the data block may be stored in a contiguous area of the main data channel. In that case, the Alternative Location specifies the first Physical Sector Number of the location in the main data channel that contains one or more copies of the data block. Otherwise, Alternative Location shall be set to zero. Note that the format of the data block as contained in the main data channel may be different from the format of the data block as contained in the ADIP Aux Frames.

Byte	Bit	7	6	5	4	3	2	1	0
0		Region Type Identifier							
1									
2									
3	Extent	Version number							
4		Reserved							
:									
15									

Figure B.4 – Extended Region Descriptor

Region Type Identifier: the Region Type Identifier shall be identical to the Region Type Identifier contained in the preceding Basic Region Descriptor.

Extent: The Extent bit shall indicate if this Extended Region Descriptor is followed by another Extended Region Descriptor, as follows:

- 0: This Extended Region Descriptor is not followed by another Extended Region Descriptor.
- 1: This Extended Region Descriptor is followed by another Extended Region Descriptor.

Version Number: the Version Number shall be identical to the Version Number contained in the preceding Basic Region Descriptor.

Reserved: All reserved bytes shall be set to (00).



Annex C (normative)

Measurement of light reflectivity

C.1 Calibration method

The reflectivity of a disk can be measured in several ways. The two most common methods are:

- parallel method,
- focused method.

For use in players the focused method with the help of a reference disk with known reflectivity is the most relevant and easiest one, while for the calibration of the reference disk the parallel method is easier.

When measuring the reflectivity in the focused way, only the light returned by the reflective layer of the disk (R_m) will fall onto the photo detector. The reflected light coming from the front surface of the disk and the light coming from the parasitic reflections inside the disk will mainly fall outside the photo detector. Because in the parallel method only the "total" reflectance ($R_{//}$) can be measured, a calculation is needed to determine the "main" reflectance from the reflective layer.

A good reference disk shall be chosen, for instance 0,6 mm glass disk with a golden reflective mirror. This reference disk shall be measured by a parallel beam as shown in Figure C.1

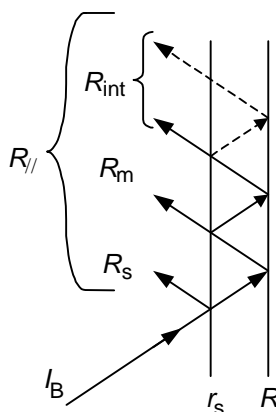

Figure C.1 - Reflectivity calibration

In this Figure the following applies:

R = reflectance of the recording layer (including the double pass substrate transmittance)

r_s = reflectance of the entrance surface

R_{ref} = reflectance as measured by the focussed beam (is by definition = R_m / I_B)

I_B = incident beam

R_s = reflectance caused by the reflectivity of the entrance surface

R_m = main reflectance caused by the reflectivity of the recording layer

R_{int} = reflectance caused by the internal reflections between the entrance surface and the recording layer

$R_{//}$ = measured value ($R_s + R_m + R_{int}$)

The reflectance of the entrance surface is defined by:

$$r_s = \left(\frac{n-1}{n+1} \right)^2, \text{ where } n \text{ is the index of refraction of the substrate.}$$

The main reflectance $R_m = R_{//} - R_s - R_{int}$ which leads to:

$$R_{ref} = \frac{R_m}{I_B} = \left[\frac{(1-r_s)^2 \times \left(\frac{R_{//}}{I_B} - r_s \right)}{1-r_s \times \left(2 - \frac{R_{//}}{I_B} \right)} \right]$$

The reference disk shall be measured on a reference drive. The total detector current ($I_1 + I_2$) obtained from the reference disk, and measured by the focused beam is equated to R_m as determined above.

Now the arrangement is calibrated and the focused reflectance is a linear function of the reflectivity of the recording layer and the double pass substrate transmission, independently from the reflectivity of the entrance surface.

C.2 Measuring method

Reflectivity in the unrecorded Information Zone

A method of measuring the reflectance using the reference drive.

- (1) Measure the total detector current $(I_1 + I_2)_s$ from the reference disk with calibrated reflectance R_{ref} .
- (2) Measure the total detector current $(I_1 + I_2)_g$ from a groove track in an area of the disk under investigation where the groove track and the two adjacent tracks on each side of the track to be measured have been erased. Erasure of these tracks shall be done by irradiating the tracks using only the Pe power as determined from the OPC algorithm (see Annex I).
- (3) Calculate the unrecorded disk reflectance R_d as follows

$$R_d = \frac{(I_1 + I_2)_g}{(I_1 + I_2)_s} \times R_{ref}$$

Reflectivity in the recorded Information Zone

A method of measuring the reflectance using the reference drive.

- (1) Measure the total detector current $(I_1 + I_2)_s$ from the reference disk with calibrated reflectance R_{ref} .
- (2) Measure I_{14H} from a recorded groove track in an area of the disk under investigation where at least the two adjacent tracks on each side of the track to be measured also have been recorded. Recording of these tracks shall be done using the optimum powers as determined from the OPC algorithm (see Annex I).
- (3) Calculate the recorded disk reflectance R_{14H} as follows:

$$R_{14H} = \frac{I_{14H}}{(I_1 + I_2)_s} \times R_{ref}$$

Annex D (normative)

Measurement of birefringence

D.1 Principle of the measurement

In order to measure the birefringence, circularly polarized light in a parallel beam is used. The phase retardation is measured by observing the ellipticity of the reflected light.

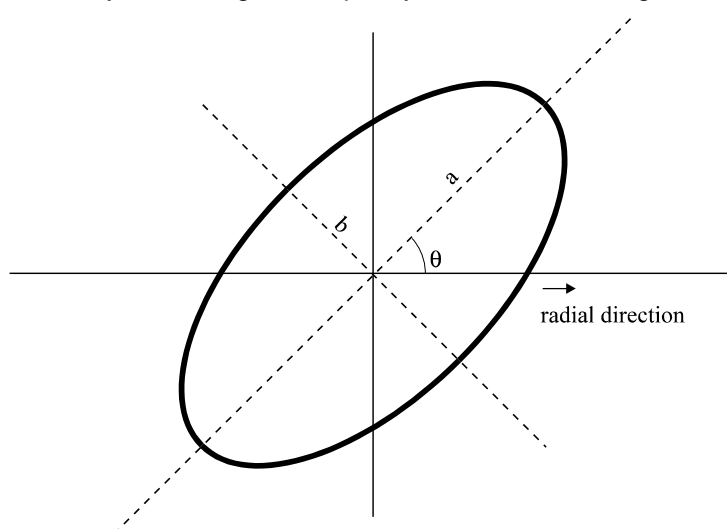

Figure D.1 - Ellipse with ellipticity $e = b/a$ and orientation θ

The orientation θ of the ellipse is determined by the orientation of the optical axis

$$\theta = \gamma - \pi/4 \quad (1)$$

where γ is the angle between the optical axis and the radial direction.

The ellipticity, $e = b/a$, is a function of the phase retardation δ

$$e = \tan \left[\frac{1}{2} \left(\frac{\pi}{2} - \delta \right) \right] \quad (2)$$

When the phase retardation δ is known the birefringence BR can be expressed as a fraction of the wavelength

$$BR = \frac{\lambda}{2\pi} \delta \text{ nm} \quad (3)$$

Thus, by observing the elliptically polarized light reflected from the disk, the birefringence can be measured and the orientation of the optical axis can be assessed as well.

D.2 Measurements conditions

The measurement of the birefringence specified above shall be made under the following conditions.

Mode of measurement in reflection, double pass through the substrate.

Wavelength λ of the laser light	640 nm \pm 15 nm
Beam diameter (FWHM)	1,0 mm \pm 0,2 mm
Angle β of incidence in radial direction relative to the radial plane perpendicular to Reference Plane P	7,0° \pm 0,2°
Disk mounting	horizontally
Rotation	less than 1 Hz
Temperature and relative humidity	as specified in 8.1.1

D.3 Example of a measurement set-up

Whilst this Ecma Standard does not prescribe a specific device for measuring birefringence, the device shown schematically in Figure D.2 as an example, is well suited for this measurement.

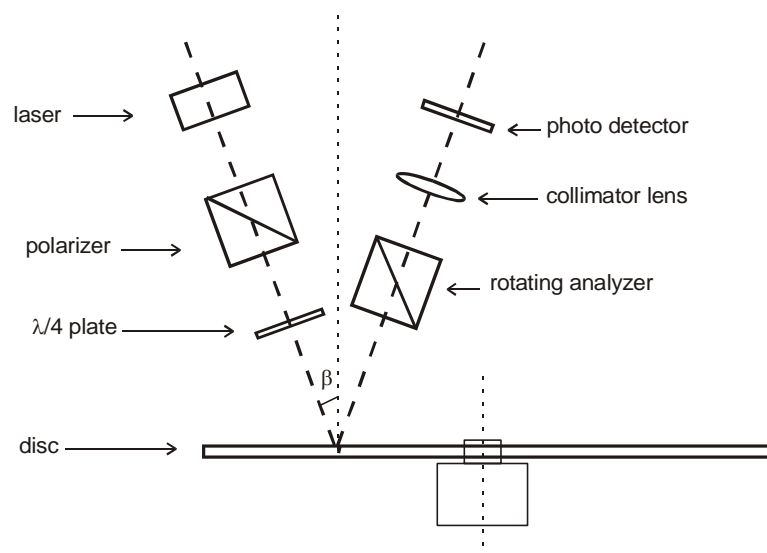

Figure D.2 - Example of a device for the measurement of birefringence

Light from a laser source, collimated into a polarizer (extinction ratio $\approx 10^{-5}$), is made circular by a $\lambda/4$ plate. The ellipticity of the reflected light is analyzed by a rotating analyzer and a photo detector. For every location on the disk, the minimum and the maximum values of the intensity are measured. The ellipticity can then be calculated as

$$e^2 = \frac{I_{\min}}{I_{\max}} \quad (4)$$

Combining equations (2), (3), and (4) yields

$$BR = \frac{\lambda}{4} - \frac{\lambda}{\pi} \arctan \sqrt{\frac{I_{\min}}{I_{\max}}}$$

This device can be easily calibrated as follows

- I_{\min} is set to 0 by measuring a polarizer or a $\lambda/4$ plate,
- $I_{\min} = I_{\max}$ when measuring a mirror

Apart of the d.c. contribution of the front surface reflection, a.c. components may occur, due to the interference of the reflection(s) of the front surface with the reflection(s) from the recording layer. These a.c. reflectivity effects are significant only if the disk substrate has an extremely accurate flatness and if the light source has a high coherence.

Annex E (normative)

Measuring conditions for operation signals

E.1 System diagram for jitter measurement and determination of the characteristics of user data

The general system diagram shall be as shown in Figure E.1.

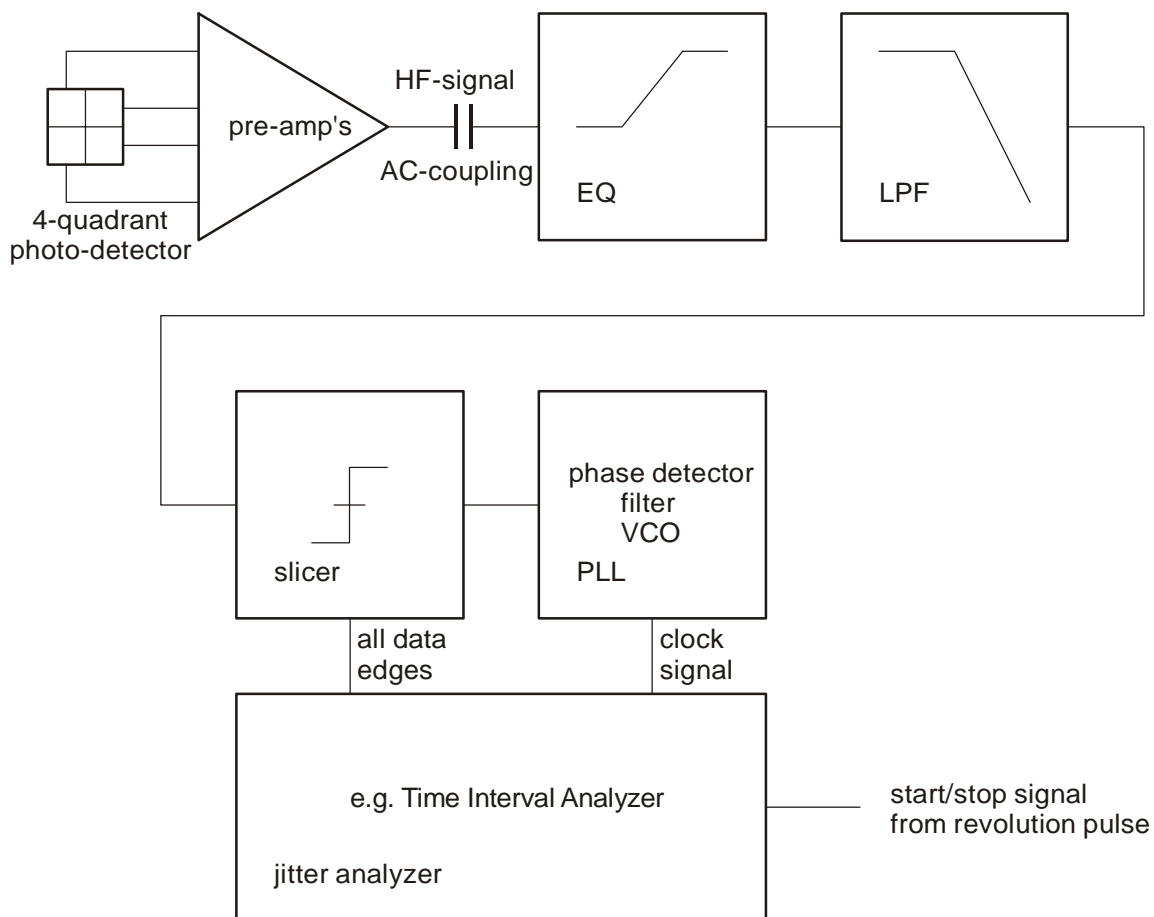

Figure E.1 - General diagram for jitter measurement

E.2 Open loop transfer function for PLL

The open-loop transfer function for the PLL shall be as shown in Figure E.2

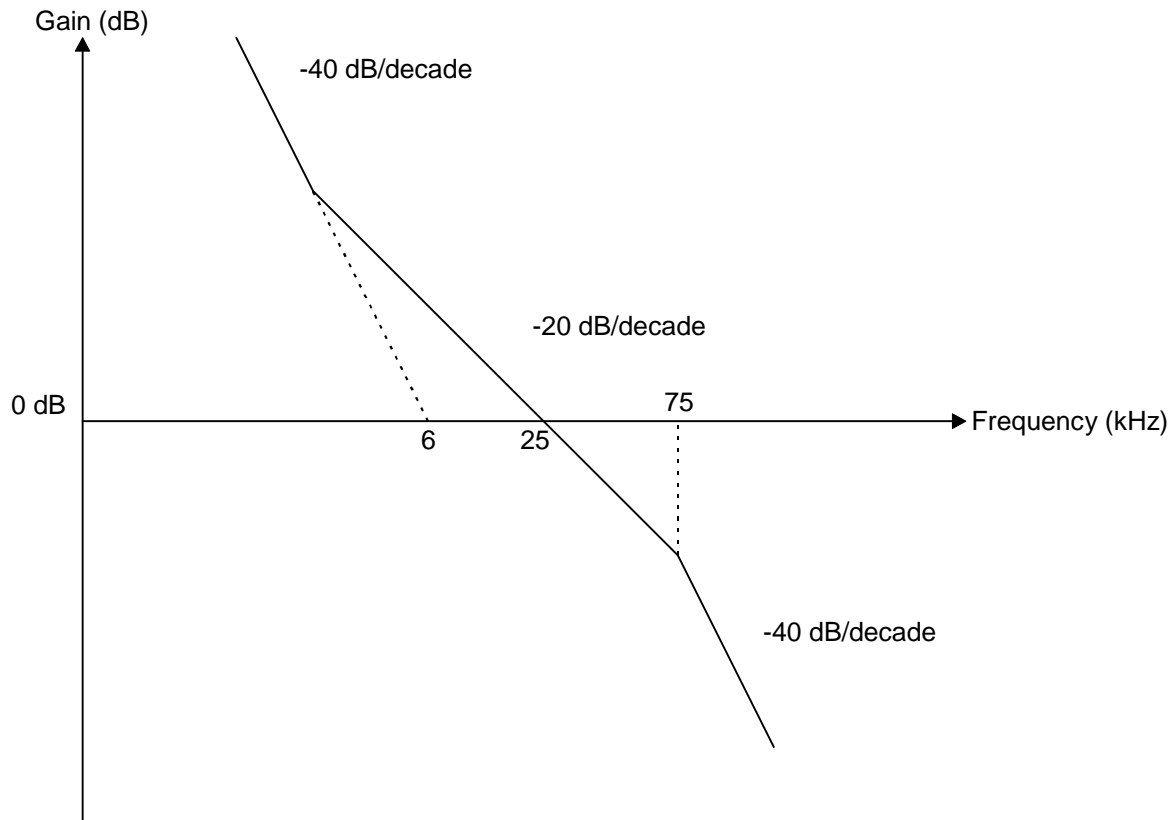

Figure E.2 - Schematic representation of the open-loop transfer function for PLL

E.3 Slicer

The slicer shall be a 1st order, integrating feed-back auto-slicer with a -3 dB closed-loop bandwidth of 5 kHz.

E.4 Conditions for measurement

The bandwidth of the pre-amplifier of the photo detector shall be greater than 20 MHz in order to prevent group-delay distortion.

Equalizer: 3-tap transversal filter with transfer function $H(z) = 1,364 z^{-2} - 0,182 (1 + z^{-4})$

Low-pass filter: 6th order Bessel filter, f_c (-3 dB) = 8,2 MHz

Filtering plus equalization:

- Gain variation: 1 dB max. (below 7 MHz)
- Group delay variation: 1 ns max. (below 7 MHz)
- (Gain at 5,0 MHz - Gain at 0 Hz): $3,2 \text{ dB} \pm 0,3 \text{ dB}$

a.c. coupling (high-pass filter) = 1st order, f_c (-3 dB) = 1 kHz

Correction of the angular deviation: only d.c. deviation shall be corrected.

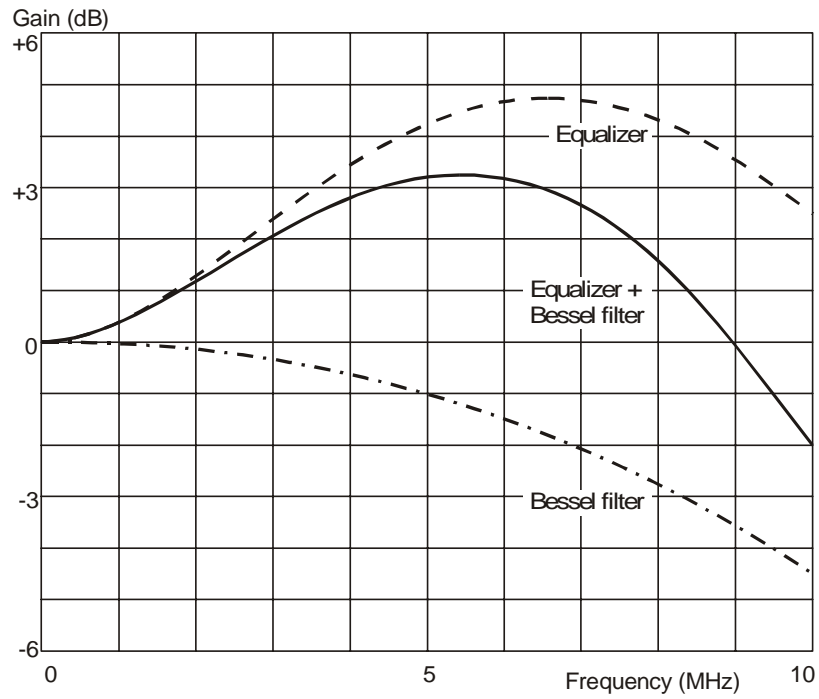

Figure E.3 - Frequency characteristics for the equalizer and the low-pass filter

E.5 Measurement

The jitter of all leading and trailing edges over one revolution shall be measured.



Annex F (normative)

Measurement of the differential phase tracking error

F.1 Measuring method for the differential phase tracking error

The reference circuit for the measurement of the tracking error shall be that shown in Figure F.1. Each output of the diagonal pairs of elements of the quadrant photo detector shall be converted to binary signals independently after equalization of the wave form with the transfer function defined by:

$$H(i\omega) = (1 + 1,6 \times 10^{-7} \times i\omega) / (1 + 4,7 \times 10^{-8} \times i\omega)$$

The gain of the comparators shall be sufficient to reach full saturation on the outputs, even with minimum signal amplitudes. Phases of the binary pulse signal edges (signals B1 and B2) shall be compared to each other to produce a time-lead signal C1 and a time-lag signal C2. The phase comparator shall react to each individual edge with signal C1 or C2, depending on the sign of Δt_i . A tracking error signal shall be produced by smoothing the C1, C2 signals with low-pass filters and by subtracting by means of a unity gain differential amplifier. The low-pass filters shall be 1st order filters with a cut-off frequency (-3 dB) of 30 kHz.

Special attention shall be given to the implementation of the circuit because very small time differences have to be measured (1 % of T equals only 0,38 ns). Careful averaging is needed.

The average time difference between two signals from the diagonal pairs of elements of the quadrant detector shall be

$$\overline{\Delta t} = \frac{1}{N} \sum \Delta t_i$$

where N is the number of edges, both rising and falling.

F.2 Measurement of $\overline{\Delta t}/T$ without time interval analyzer

The relative time difference $\overline{\Delta t}/T$ is represented by the amplitude of the tracking error signal provided that the amplitudes of the C1 and C2 signals and the frequency component of the read-out signals are normalized. The relation between the tracking error amplitude $\overline{\Delta TVE}$ and the time difference is given by:

$$\overline{\Delta TVE} = \frac{\sum \Delta t_i}{\sum T_i} V_{pc} = \frac{\sum \Delta t_i}{NnT} V_{pc} = \frac{\overline{\Delta t}}{T} \times \frac{V_{pc}}{n}$$

where:

V_{pc} is the amplitude of the C1 and C2 signals

T_i is the actual length of the read-out signal in the range 3T to 14T

$n.T$ is the weighted average value of the actual lengths

$N.n.T$ is the total averaging time.

The specification for the tracking gain can now be rewritten by using the tracking error amplitude as follows:

$$0,50 \times \left(\frac{V_{pc}}{n} \right) \leq \overline{\Delta TVE} \leq 1,10 \times \left(\frac{V_{pc}}{n} \right) \text{ at } 0,1 \mu\text{m radial offset.}$$

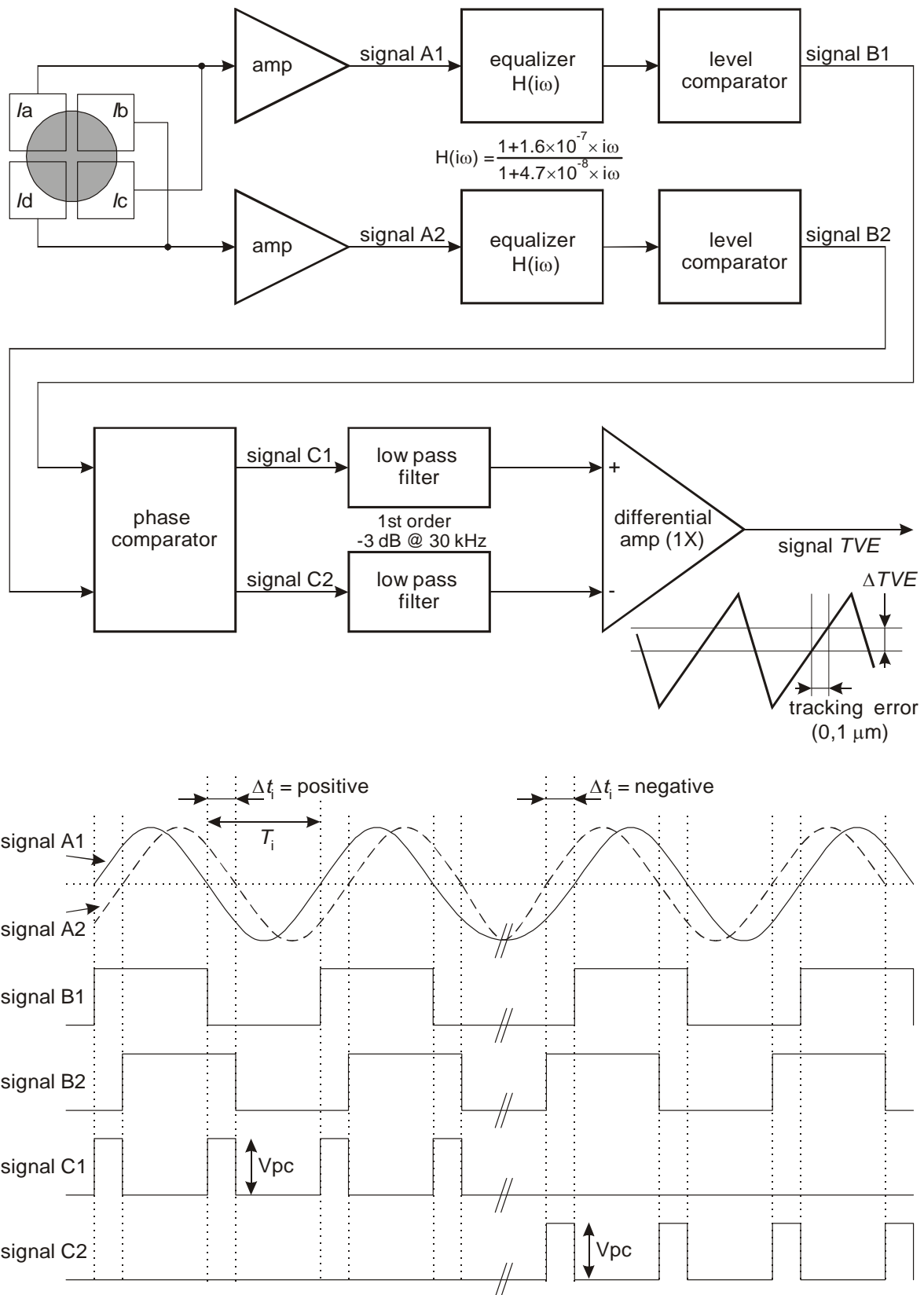

Figure F.1 - Circuit for tracking error measurements

F.3 Calibration of the circuit

Assuming that V_{pc} equals ≈ 5 V and that the measured value of n equals ≈ 5 , then the above relation between the tracking error amplitude $\overline{\Delta TVE}$ and the time difference $\overline{\Delta t}$ can be simplified to:

$$\overline{\Delta TVE} = \frac{\overline{\Delta t}}{T} \times \frac{V_{pc}}{n} \approx \frac{\overline{\Delta t}}{T}$$

The average runlength n of the 8-to-16 modulated signal is depending on the data content and the averaging time. Therefore the circuit shall be calibrated with a fixed frequency signal, corresponding to a modulated signal with 5T runlengths. For this purpose sinusoidal signals with a frequency of 2,616 MHz can be used.

Typically the pulses of signals C1 and C2 will be generated by some digital gate circuit with an output signal switching between ground and the supply voltage. This voltage swing is assumed to be about 5 volts, however, depending on the applied technology, it may deviate from 5 volts significantly.

Because the formal specification for the DPD signal is:

$$0,50 \leq \frac{\overline{\Delta t}}{T} \leq 1,10 \text{ at } 0,1 \mu\text{m radial offset,}$$

the measurement by means of $\overline{\Delta TVE}$ is influenced by the actual values of V_{pc} and n . Therefore the following calibration procedure shall be applied.

F.3.1 Saturation of comparators

Make sure that the gain of the level comparators is such that for all actual input signal levels, the signals B1 and B2 are square wave signals. In this case the amplitude of the signal TVE is independent of the amplitude of the input signals.

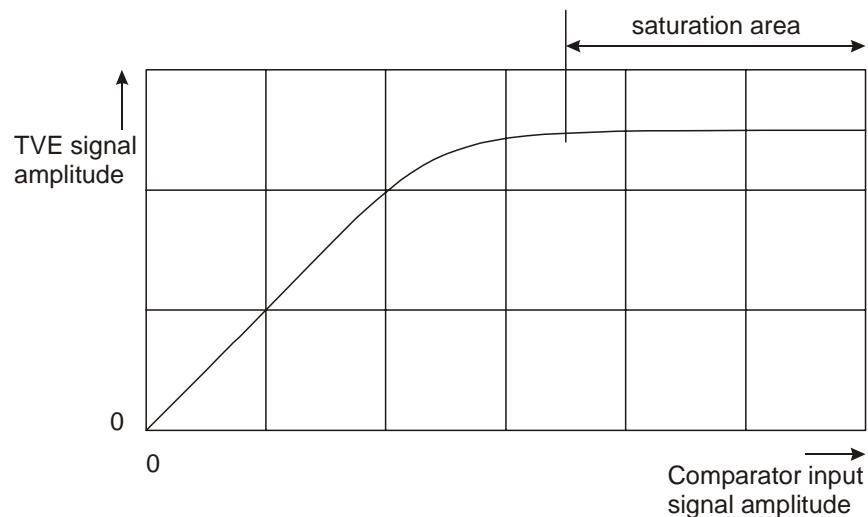

Figure F.2 - Tracking error signal amplitude versus comparator input signal amplitude

F.3.2 Correction for n and Vpc

Because of the above mentioned deviations of n and Vpc, and possibly some other circuit parameters, a correction factor K has to be determined, such that:

$$\overline{\Delta t/T}(\text{real}) = K \times \overline{\Delta TVE}(\text{measured}).$$

This can be achieved in the following way:

- a) Generate two sinusoidal signals A1 and A2 of frequency 2,616 MHz with a phase difference, and inject them into the two equalizer circuits.
- b) Measure the relation between $\overline{\Delta t/T}$ and $\overline{\Delta TVE}$, and determine K from Figure F.3:

$$K = \frac{\overline{\Delta t/T}(\text{injected})}{\overline{\Delta TVE}(\text{measured})}. \text{ Now the set-up is ready for use.}$$

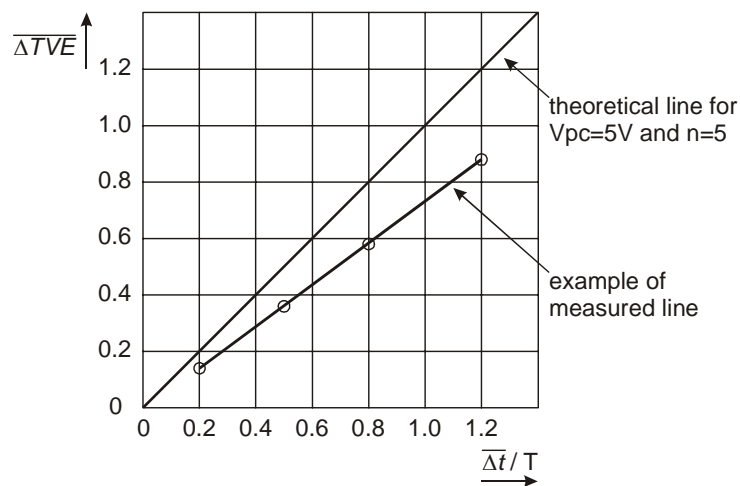

Figure F.3 - $\overline{\Delta TVE}$ versus $\overline{\Delta t/T}$

Annex G (normative)

The write pulse waveform for testing

For different speed ranges, different write strategies can be used. This version of this document specifies two options, where both options use the same write pulse waveform, however with a different timing resolution.

The write pulse waveform obtained from the NRZI data and the channel clock is shown in Figure G.1. It consists of $N-1$ pulses, where N is the length of the NRZI pulse expressed in channel clock cycles.

The values for P_w , P_e , and P_c are determined according to the OPC algorithm (see Annex I). An example of the write pulse waveform for the minimum mark, the minimum space and an 8T mark is shown in Figure G.2.

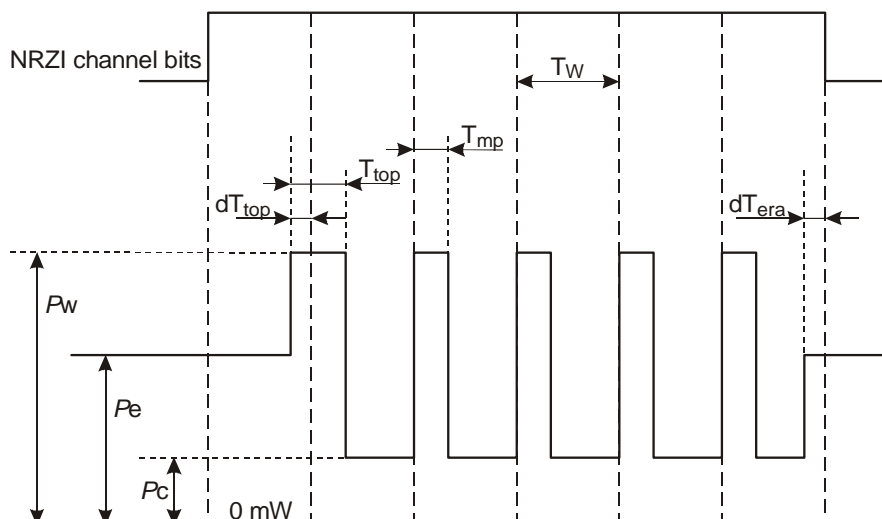

Figure G.1 - Write pulse waveform

G.1 Timing parameters for the basic write strategy

The pulse width times, T_{top} and T_{mp} shall be as indicated by byte 51 and byte 52 in 14.4.2.2 respectively. The duration is partly fixed and partly variable depending on the writing speed:

$$T_{top} = i \times \frac{1}{6} T_W + j \times 2 \text{ ns} \pm 0,5 \text{ ns}, \text{ where } i = 0, 1 \text{ or } 2 \text{ and } j = 1, 2, \dots \text{ or } 7$$

$$T_{mp} = m \times \frac{1}{6} T_W + n \times 2 \text{ ns} \pm 0,5 \text{ ns}, \text{ where } m = 0 \text{ or } 1 \text{ and } n = 1, 2, \dots \text{ or } 5$$

The first pulse lead-time and the erase lead-time shall be as indicated by byte 53 and byte 54/55/56 in 14.4.2.2 respectively. The duration is variable with the writing speed, but shall have a fixed ratio to the write clock period.

$$dT_{top} = p \times \frac{1}{6} T_W, \text{ where } p = 0, 1, 2, 3 \text{ or } 4$$

$$dT_{era} = q \times \frac{1}{6} T_W, \text{ where } q = -3, -2, -1, 0, 1, 2 \text{ or } 3$$

(positive values are leading as indicated in Figure G.1)

The laser power shall be switched to Cooling level after each T_{top} and T_{mp} pulse for at least 1 ns.

G.2 Timing parameters for the “4x” write strategy

The pulse width times, T_{top} and T_{mp} shall be as indicated by byte 86 and byte 87 in 14.4.2.3.1 respectively. The duration is partly fixed and partly variable depending on the writing speed: (0,6 ns corresponds to $\frac{1}{16} T_W$ at 4x speed)

$$T_{top} = i \times \frac{1}{16} T_W + j \times 0,6 \text{ ns} \pm 0,3 \text{ ns} , \text{ where } i = 0, 1, \dots \text{ or } 8 \text{ and } j = 1, 2 \dots \text{ or } 15$$

$$T_{mp} = m \times \frac{1}{16} T_W + n \times 0,6 \text{ ns} \pm 0,3 \text{ ns} , \text{ where } m = 0, 1, \dots \text{ or } 8 \text{ and } n = 1, 2 \dots \text{ or } 10$$

The first pulse lead-time and the erase lead-time shall be as indicated by byte 88/89/90 and byte 91/92/93 in 14.4.2.3.1 respectively. The duration is variable with the writing speed, but shall have a fixed ratio to the write clock period.

$$dT_{top} = p \times \frac{1}{16} T_W , \text{ where } p = -4, -3, \dots, -1, 0, 1, \dots \text{ or } 7$$

$$dT_{era} = (q + 4) \times \frac{1}{16} T_W , \text{ where } q = -8, -7, \dots, -1, 0, 1, \dots \text{ or } 7$$

(positive values are leading as indicated in Figure G.1)

The laser power shall be switched to Cooling level after each T_{top} and T_{mp} pulse for at least 1 ns, except after the last T_{mp} pulse where this period is allowed to be reduced to 0 length.

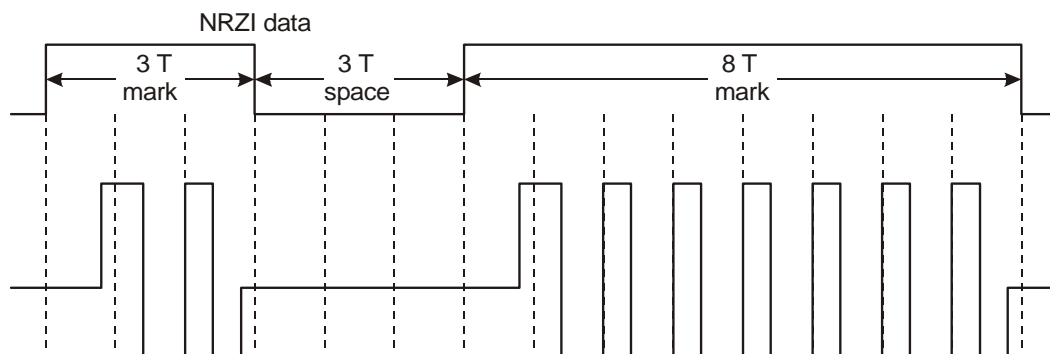

Figure G.2 - Example of a Multiple-pulse

G.3 Rise and fall times

The rise times, T_r , and fall times, T_f , as specified in Figure G.3 shall not exceed 2 ns.
Possible overshoots shall be $< 20\%$ of the step size (P_1 , P_2 or P_3).

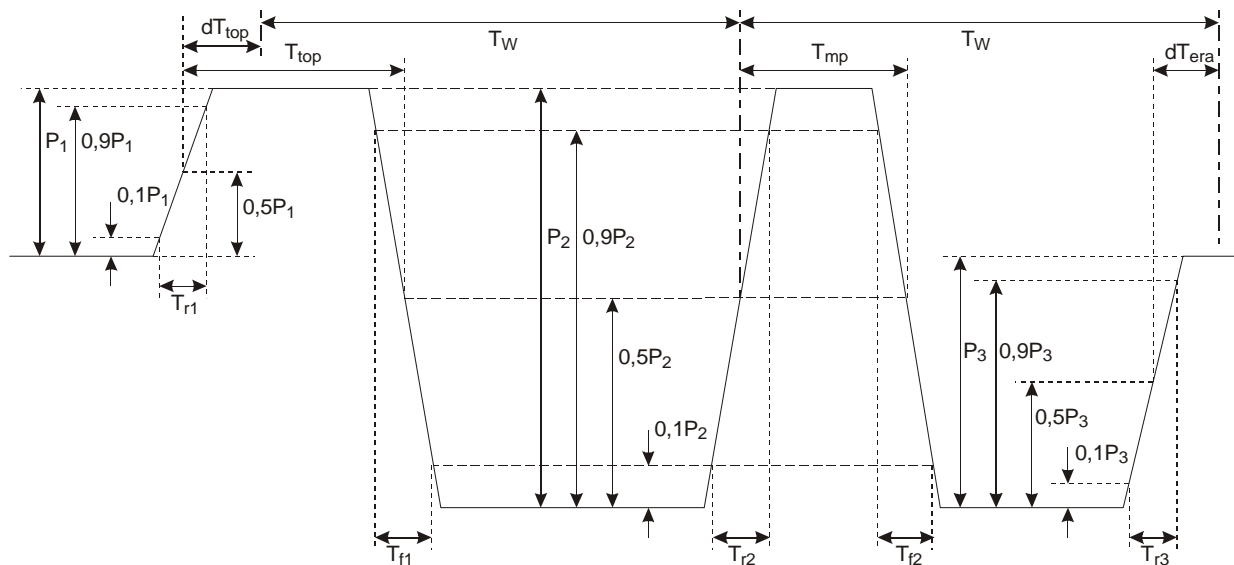
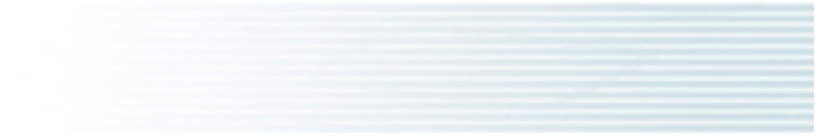

Figure G.3 - Rise Times and Fall Times



Annex H (normative)

8-to-16 Modulation

8-to-16 modulation shall satisfy RLL(2,10) requirements. The encoding system is shown in Figure H.1 with the conversion tables shown in Table H.1 and Table H.2.

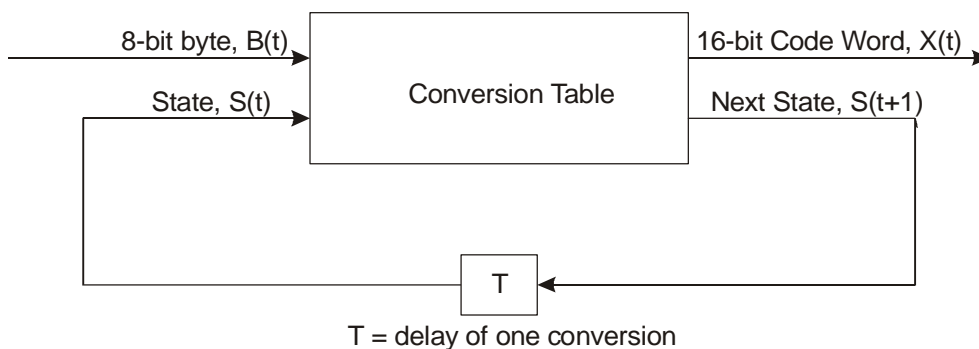

Where:

$$X(t) = H\{B(t), S(t)\} \quad X_{15}(t) = \text{msb and } X_0(t) = \text{lsb}$$

$$S(t+1) = G\{B(t), S(t)\}$$

H is the output function from the conversion tables

G is the next-state function from the conversion tables

Figure H.1 - Code Word generating system

The States of the Code Words, $X(t)$, shall be chosen to satisfy the RLL(2,10) requirements of a minimum of 2 ZEROs and a maximum of 10 ZEROs between ONES of adjacent Code Words.

Code Word $X(t)$	Next State $S(t+1)$	Code Word $X(t+1)$
Ends with 1 or no trailing ZEROs	State 1	Starts with 2 to 9 leading ZEROs
Ends with 2 to 5 trailing ZEROs	State 2	Starts with 1 or up to 5 leading ZEROs and $X_{15}(t+1), X_3(t+1) = 0,0$
Ends with 2 to 5 trailing ZEROs	State 3	Starts with none or up to 5 leading ZEROs and $X_{15}(t+1), X_3(t+1) \neq 0,0$
Ends with 6 to 9 trailing ZEROs	State 4	Starts with 1 or no leading ZEROs

Figure H.2 - Determination of States

Note that when decoding the recorded data, knowledge about the encoder is required to be able to reconstitute the original bytes.

$$B(t) = H^{-1}\{X(t), S(t)\}$$

Because of the involved error propagation, such state-dependent decoding is to be avoided. In the case of this 8-to-16 modulation, the conversion tables have been chosen in such a way that knowledge about the State is not required in most cases. As can be gathered from the tables, in some cases, two 8-bit bytes, for instance the 8-bit bytes 5 and 6 in States 1 and 2 in Table H.1 generate the same 16-bit Code Words. The

construction of the tables allows to solve this apparent ambiguity. Indeed, if two identical Code Words leave a State, one of them goes to State 2 and the other to State 3. Because the setting of bits X_{15} and X_3 is always different in these two States, any Code Word can be uniquely decoded by analysing the Code Word itself together with bits X_{15} and X_3 of the next Code Word:

$$B(t) = H^{-1}\{ X(t), X_{15}(t+1), X_3(t+1) \}$$

The Substitution table, Table H.2, is included to insure meeting the DCC requirements of 13.8.

Table H.1 - Main Conversion Table

8-bit byte	State 1			State 2			State 3			State 4		
	Code Word		Next State	Code Word		Next State	Code Word		Next State	Code Word		Next State
	msb	lsb		msb	lsb		msb	lsb		msb	lsb	
0	001000000001001	1	0100000100100000	2	001000000001001	1	0100000100100000	2				
1	001000000001010	1	0010000000010010	1	1000000100100000	3	1000000100100000	3				
2	0010000100100000	2	0010000100100000	2	1000000000010010	1	1000000000010010	1				
3	0010000001001000	2	0100010010000000	4	0010000001001000	2	0100010010000000	4				
4	0010000010010000	2	0010000010010000	2	1000000100100000	2	1000000100100000	2				
5	0010000000100100	2	0010000000100100	2	1001001000000000	4	1001001000000000	4				
6	0010000000100100	3	0010000000100100	3	1000100100000000	4	1000100100000000	4				
7	0010000001001000	3	010000000010010	1	0010000001001000	3	010000000010010	1				
8	0010000001001000	3	0010000001001000	3	1000010010000000	4	1000010010000000	4				
9	0010000100100000	3	0010000100100000	3	1001001000000001	1	1001001000000001	1				
10	0010010010000000	4	0010010010000000	4	1000100100000001	1	1000100100000001	1				
11	0010001001000000	4	0010001001000000	4	1000000010010000	3	1000000010010000	3				
12	0010010010000001	1	0010010010000001	1	1000000010010000	2	1000000010010000	2				
13	0010001001000001	1	0010001001000001	1	1000010010000001	1	1000010010000001	1				
14	0010000001001001	1	0100000000100100	3	0010000001001001	1	0100000000100100	3				
15	0010000100100001	1	0010000100100001	1	1000001001000001	1	1000001001000001	1				
16	0010000010010001	1	0010000010010001	1	1000000100100001	1	1000000100100001	1				
17	0010000000100010	1	0010000000100010	1	1000001001000000	4	1000001001000000	4				
18	0001000000001001	1	0100000010010000	2	0001000000001001	1	0100000010010000	2				
19	0010000000100010	1	0010000000100010	1	1001000100000000	4	1001000100000000	4				
20	0001000000010010	1	0001000000010010	1	1000100010000000	4	1000100010000000	4				
21	0000100000000010	1	0000100000000010	1	1000000010010001	1	1000000010010001	1				
22	0000010000000001	1	0000010000000001	1	1000000001001001	1	1000000001001001	1				
23	0010001000100000	2	0010001000100000	2	1000000001001000	2	1000000001001000	2				
24	0010000100010000	2	0010000100010000	2	1000000001001000	3	1000000001001000	3				
25	0010000010001000	2	0100000000100100	2	0010000010001000	2	0100000000100100	2				
26	0010000001000100	2	0010000001000100	2	1000000000100010	1	1000000000100010	1				
27	0001000100100000	2	0001000100100000	2	1000000000010001	1	1000000000010001	1				
28	0010000000001000	2	0100000010010000	3	0010000000001000	2	0100000010010000	3				
29	0001000010010000	2	0001000010010000	2	1001001000000010	1	1001001000000010	1				
30	0001000001001000	2	0100000100100000	3	0001000001001000	2	0100000100100000	3				
31	0001000000100100	2	0001000000100100	2	1000100010000001	1	1000100010000001	1				
32	0001000000000100	2	0001000000000100	2	1000100100000010	1	1000100100000010	1				
33	0001000000000100	3	0001000000000100	3	1000100010000001	1	1000100010000001	1				
34	0001000000100100	3	0001000000100100	3	1000000000100100	2	1000000000100100	2				
35	0001000001001000	3	0100001001000000	4	0001000001001000	3	0100001001000000	4				
36	0001000010010000	3	0001000010010000	3	1000000000100100	3	1000000000100100	3				
37	0001000100100000	3	0001000100100000	3	1000010001000000	4	1000010001000000	4				
38	0010000000001000	3	0100100100000001	1	0010000000001000	3	0100100100000001	1				
39	0010000001000100	3	0010000001000100	3	1001000010000000	4	1001000010000000	4				
40	0010000010001000	3	0100010010000001	1	0010000010001000	3	0100010010000001	1				
41	0010000100010000	3	0010000100010000	3	1000010010000010	1	1000010010000010	1				
42	0010001000100000	3	0010001000100000	3	1000001000100000	2	1000001000100000	2				
43	0010010000100000	4	0010010000100000	4	1000010001000001	1	1000010001000001	1				
44	0001001001000000	4	0001001001000000	4	1000001000100000	3	1000001000100000	3				
45	0000001000000001	1	0100010001000000	4	1000001001000010	1	0100010001000000	4				
46	0010010010000010	1	0010010010000010	1	1000001000100001	1	1000001000100001	1				
47	0010000010001001	1	0100001001000001	1	0010000010001001	1	0100001001000001	1				
48	0010010001000001	1	0010010001000001	1	1000000100010000	2	1000000100010000	2				
49	0010001001000010	1	0010001001000010	1	1000000010001000	2	1000000010001000	2				
50	0010001000100001	1	0010001000100001	1	1000000100010000	3	1000000100010000	3				

Table H.1 - Main Conversion Table (continued)

8-bit byte	State 1			State 2			State 3			State 4		
	Code Word		Next State	Code Word		Next State	Code Word		Next State	Code Word		Next State
	msb	lsb		msb	lsb		msb	lsb		msb	lsb	
51	0001000001001001	1	0100000100100001	1	0001000001001001	1	0100000100100001	1				
52	0010000100100010	1	0010000100100010	1	1000000100100010	1	1000000100100010	1				
53	0010000100010001	1	0010000100010001	1	1000000100010001	1	1000000100010001	1				
54	0010000010010010	1	0010000010010010	1	1000000010010010	1	1000000010010010	1				
55	0010000001000010	1	0010000001000010	1	1000000010000010	1	1000000010000010	1				
56	0010000000100001	1	0010000000100001	1	1000000001000001	1	1000000001000001	1				
57	0000100000001001	1	0100000010010001	1	0000100000001001	1	0100000010010001	1				
58	0001001001000001	1	0001001001000001	1	1000000000100001	1	1000000000100001	1				
59	0001000100100001	1	0001000100100001	1	0100000001001001	1	0100000001001001	1				
60	0001000010010001	1	0001000010010001	1	1001001000010010	1	1001001000010010	1				
61	0001000000100010	1	0001000000100010	1	1001001000001001	1	1001001000001001	1				
62	0001000000010001	1	0001000000010001	1	1001000100000010	1	1001000100000010	1				
63	0000100000010010	1	0000100000010010	1	1000000001000100	2	1000000001000100	2				
64	0000010000000010	1	0000010000000010	1	0100000001001000	2	0100000001001000	2				
65	0010010000100000	2	0010010000100000	2	1000010000100000	2	1000010000100000	2				
66	0010001000010000	2	0010001000010000	2	1000001000010000	2	1000001000010000	2				
67	0010000100001000	2	0100000000100010	1	0010000100001000	2	0100000000100010	1				
68	0010000010000100	2	0010000010000100	2	1000000100001000	2	1000000100001000	2				
69	0010000000010000	2	0010000000010000	2	1000000010000100	2	1000000010000100	2				
70	0001000010001000	2	0100001000100000	2	0001000010001000	2	0100001000100000	2				
71	0001001000100000	2	0001001000100000	2	0100000010001000	2	0100000010001000	2				
72	0001000000001000	2	0100000010001000	2	0001000000001000	2	0100000010001000	2				
73	0001000100010000	2	0001000100010000	2	1000000001000100	3	1000000001000100	3				
74	0001000001000100	2	0001000001000100	2	0100000001001000	3	0100000001001000	3				
75	0000100100100000	2	0000100100100000	2	1000010000100000	3	1000010000100000	3				
76	0000100010010000	2	0000100010010000	2	1000001000010000	3	1000001000010000	3				
77	0000100001001000	2	0100000001000100	2	0000100001001000	2	0100000001000100	2				
78	0000100000100100	2	0000100000100100	2	1000000100001000	3	1000000100001000	3				
79	0000100000000100	2	0000100000000100	2	1000000010000100	3	1000000010000100	3				
80	0000100000000100	3	0000100000000100	3	0100000010001000	3	0100000010001000	3				
81	0000100000100100	3	0000100000100100	3	1000100001000000	4	1000100001000000	4				
82	0000100001001000	3	0100000001000100	3	0000100001001000	3	0100000001000100	3				
83	0000100010010000	3	0000100010010000	3	1000000010001000	3	1000000010001000	3				
84	0000100100100000	3	0000100100100000	3	1001001001001000	2	1001001001001000	2				
85	0001000000001000	3	0100000100010000	3	0001000000001000	3	0100000100010000	3				
86	0001000001000100	3	0001000001000100	3	1001001000100100	2	1001001000100100	2				
87	0001000010001000	3	0100001000100000	3	0001000010001000	3	0100001000100000	3				
88	0001000100010000	3	0001000100010000	3	1001001001001000	3	1001001001001000	3				
89	0001001000100000	3	0001001000100000	3	1001000010000001	1	1001000010000001	1				
90	0010000000010000	3	0010000000010000	3	1000100100010010	1	1000100100010010	1				
91	0010000010000100	3	0010000010000100	3	1000100100001001	1	1000100100001001	1				
92	0010000100001000	3	0100000000100010	1	0010000100001000	3	0100000000100010	1				
93	0010001000010000	3	0010001000010000	3	1000100010000010	1	1000100010000010	1				
94	0010010000100000	3	0010010000100000	3	1000100001000001	1	1000100001000001	1				
95	0000001000000010	1	0100100100000010	1	1000010010010010	1	0100100100000010	1				
96	0000000100000001	1	0100100010000001	1	1000010010001001	1	0100100010000001	1				
97	0010010010001001	1	0100010000100000	2	0010010010001001	1	0100010000100000	2				
98	0010010010010010	1	0010010010010010	1	1001001000000100	2	1001001000000100	2				
99	0010010001000010	1	0010010001000010	1	1001001000010010	3	1001001000010010	3				
100	0010010000100001	1	0010010000100001	1	1000010001000010	1	1000010001000010	1				
101	0010001001001001	1	0100010010000010	1	0010001001001001	1	0100010010000010	1				
102	0010001000100010	1	0010001000100010	1	1000010000100001	1	1000010000100001	1				
103	0010001000010001	1	0010001000010001	1	1000001001001001	1	1000001001001001	1				
104	0010000100010010	1	0010000100010010	1	1000000100010001	1	1000000100010001	1				
105	0010000010000010	1	0010000010000010	1	10000001000010001	1	10000001000010001	1				
106	0010000100001001	1	0100001000010000	2	0010000100001001	1	0100001000010000	2				
107	0010000001000001	1	0010000001000001	1	1000000100010010	1	1000000100010010	1				
108	0001001001000010	1	0001001001000010	1	1000000100001001	1	1000000100001001	1				
109	0001001000100001	1	0001001000100001	1	1000000010000010	1	1000000010000010	1				
110	0001000100100010	1	0001000100100010	1	1000000001000001	1	1000000001000001	1				

Table H.1 - Main Conversion Table (continued)

8-bit byte	State 1			State 2			State 3			State 4		
	Code Word msb	lsb	Next State	Code Word msb	lsb	Next State	Code Word msb	lsb	Next State	Code Word msb	lsb	Next State
111	0001000100010001		1	0001000100010001		1	0100000010001001		1	0100000010001001		1
112	0001000010010010		1	0001000010010010		1	1001001001001001		1	1001001001001001		1
113	0001000001000010		1	0001000001000010		1	1001001000100010		1	1001001000100010		1
114	0001000010001001		1	0100010000100000		3	0001000010001001		1	0100010000100000		3
115	0001000000100001		1	0001000000100001		1	1001001000010001		1	1001001000010001		1
116	0000100100100001		1	0000100100100001		1	1001000100010010		1	1001000100010010		1
117	0000100010010001		1	0000100010010001		1	1001000100001001		1	1001000100001001		1
118	0000100010001001		1	0100010001000001		1	000010001001001		1	0100010001000001		1
119	0000100000100010		1	0000100000100010		1	1000100100100100		2	1000100100100100		2
120	0000100000010001		1	0000100000010001		1	1000100100000100		2	1000100100000100		2
121	0000010000001001		1	0100001001000010		1	0000010000001001		1	0100001001000010		1
122	0000010000010010		1	0000010000010010		1	1000100000100000		2	1000100000100000		2
123	0010010010000100		2	0010010010000100		2	1000010010000100		2	1000010010000100		2
124	0010010000010000		2	0010010000010000		2	1000010000010000		2	1000010000010000		2
125	0010001000001000		2	0100001000100001		1	0010001000001000		2	0100001000100001		1
126	0010001001000100		2	0010001001000100		2	1000001001000100		2	1000001001000100		2
127	0001000100001000		2	0100000100100010		1	0001000100001000		2	0100000100100010		1
128	0010000100100100		2	0010000100100100		2	1000001000001000		2	1000001000001000		2
129	0000100010001000		2	0100000100010001		1	0000100010001000		2	0100000100010001		1
130	0010000100000100		2	0010000100000100		2	1000000100100100		2	1000000100100100		2
131	0010000000100000		2	0010000000100000		2	1001001000000100		3	1001001000000100		3
132	0001001000001000		2	0001001000001000		2	1000100100100100		3	1000100100100100		3
133	0000100000001000		2	0100000010010010		1	0000100000001000		2	0100000010010010		1
134	0001000010000100		2	0001000010000100		2	1000100000100000		3	1000100000100000		3
135	0001000000010000		2	0001000000010000		2	1000010010000100		3	1000010010000100		3
136	0000100100010000		2	0000100100010000		2	1000010000010000		3	1000010000010000		3
137	0000100001000100		2	0000100001000100		2	1000001001000100		3	1000001001000100		3
138	0000010001001000		2	0100000001000010		1	0000010001001000		2	0100000001000010		1
139	0000010010010000		2	0000010010010000		2	1000001000001000		3	1000001000001000		3
140	0000010000100100		2	0000010000100100		2	1001000010000010		1	1001000010000010		1
141	0000010000000100		2	0000010000000100		2	1000000100000010		2	1000000100000010		2
142	0000010000000010		3	0000010000000010		3	1000000100100100		3	1000000100100100		3
143	0000010000100100		3	0000010000100100		3	1000000100000100		3	1000000100000100		3
144	0000010001001000		3	0100000010000100		2	0000010001001000		3	0100000010000100		2
145	0000010010010000		3	0000010010010000		3	1001000001000000		4	1001000001000000		4
146	0000100000001000		3	0100000000100000		2	0000100000001000		3	0100000000100000		2
147	0000100001000100		3	0000100001000100		3	1000000000100000		2	1000000000100000		2
148	0000100010001000		3	0100000010000100		3	0000100010001000		3	0100000010000100		3
149	0000100100010000		3	0000100100010000		3	1000000000100000		3	1000000000100000		3
150	0001000000010000		3	0001000000010000		3	0100000100001000		3	0100000100001000		3
151	0001000010000100		3	0001000010000100		3	1000000001000000		4	1000000001000000		4
152	0001000100001000		3	0100001000010000		3	0001000100001000		3	0100001000010000		3
153	0001001000001000		3	0001001000001000		3	1001000001000001		1	1001000001000001		1
154	0010000000100000		3	0010000000100000		3	0100000100001000		2	0100000100001000		2
155	0010000100000100		3	0010000100000100		3	1001000100100100		3	1001000100100100		3
156	0010000100100100		3	0010000100100100		3	1000100100100010		1	1000100100100010		1
157	0010001000001000		3	0100000000100001		1	0010001000001000		3	0100000000100001		1
158	0010001001000100		3	0010001001000100		3	1000100100000100		3	0100100100000000		4
159	0010010000010000		3	0010010000010000		3	1001001001000100		2	1001001001000100		2
160	0010010010000100		3	0010010010000100		3	1001001000001000		2	1001001000001000		2
161	0000001000010010		1	0100000000010000		3	1000100100010001		1	0100000000010000		3
162	0000001000001001		1	0100100100100100		2	1000100010010010		1	0100100100100100		2
163	0000000100000010		1	0100100100100100		3	1000100010001001		1	0100100100100100		3
164	0000000010000001		1	0100100100010010		1	1000100001000010		1	0100100100010010		1
165	0010010010010001		1	0010010010010001		1	1001000100100100		2	1001000100100100		2
166	0010010000100010		1	0010010000100010		1	1001000100000100		2	1001000100000100		2
167	0010010001001001		1	0100100100000100		2	0010010001001001		1	0100100100000100		2
168	0010010000010001		1	0010010000010001		1	1001001001000100		3	1001001001000100		3
169	0010001000010010		1	0010001000010010		1	1000100000100001		1	1000100000100001		1
170	0010000100000010		1	0010000100000010		1	1000010010010001		1	1000010010010001		1

Table H.1 - Main Conversion Table (continued)

8-bit byte	State 1			State 2			State 3			State 4		
	Code Word msb	lsb	Next State	Code Word msb	lsb	Next State	Code Word msb	lsb	Next State	Code Word msb	lsb	Next State
171	0010001000001001		1	0100100000100000		3	0010001000001001		1	0100100000100000		3
172	0010000010000001		1	0010000010000001		1	1000010001001001		1	1000010001001001		1
173	0001001000100010		1	0001001000100010		1	1000010000100010		1	1000010000100010		1
174	0001001000010001		1	0001001000010001		1	1000010000010001		1	1000010000010001		1
175	0001000100010010		1	0001000100010010		1	1000001000010010		1	1000001000010010		1
176	0001000010000010		1	0001000010000010		1	1000001000001001		1	1000001000001001		1
177	0001001001001001		1	010010010000010		1	0001001001001001		1	010010010000010		1
178	0001000001000001		1	0001000001000001		1	1000000100000010		1	1000000100000010		1
179	0000100100100010		1	0000100100100010		1	1000000010000001		1	1000000010000001		1
180	0000100100010001		1	0000100100010001		1	0100100100001001		1	0100100100001001		1
181	0001000100001001		1	0100100000100000		2	0001000100001001		1	0100100000100000		2
182	0000100010010010		1	0000100010010010		1	0100010010001001		1	0100010010001001		1
183	0000100001000010		1	0000100001000010		1	0000100100100101		1	0000100100100101		1
184	0000100010001001		1	0100010010000100		3	0000100010001001		1	0100010010000100		3
185	0000100000100001		1	0000100000100001		1	1001000000100000		2	1001000000100000		2
186	0000010010010001		1	0000010010010001		1	1000100100001000		2	1000100100001000		2
187	0000010000100010		1	0000010000100010		1	1000100010000100		2	1000100010000100		2
188	0000010001001001		1	0100100001000001		1	0000010001001001		1	0100100001000001		1
189	0000010000010001		1	0000010000010001		1	1000100000010000		2	1000100000010000		2
190	0000001001001000		2	0100010010000100		2	1000010010001000		2	0100010010000100		2
191	0000001000100100		2	0100010000010000		2	1000010001000100		2	0100010000010000		2
192	0000001000000100		2	0100001001000100		2	1000010000001000		2	0100001001000100		2
193	0010010010001000		2	0100010000010000		3	0010010010001000		2	0100010000010000		3
194	0010010001000100		2	0010010001000100		2	1000001001001000		2	1000001001001000		2
195	0010010000001000		2	0100010010010010		1	0010010000001000		2	0100010010010010		1
196	0010001000100100		2	0010001000100100		2	1000001000100100		2	1000001000100100		2
197	0010001000000100		2	0010001000000100		2	1000001000000100		2	1000001000000100		2
198	0010001001001000		2	0100010001000010		1	0010001001001000		2	0100010001000010		1
199	0001001001000100		2	0001001001000100		2	0100001000001000		2	0100001000001000		2
200	0001000100100100		2	0001000100100100		2	1001000000100000		3	1001000000100000		3
201	0001000100000100		2	0001000100000100		2	1000100100001000		3	1000100100001000		3
202	0001001000001000		2	0100010000100001		1	0001001000001000		2	0100010000100001		1
203	0001000000100000		2	0001000000100000		2	1000100010000100		3	1000100010000100		3
204	0000100010000100		2	0000100010000100		2	1000010010001000		3	1000010010001000		3
205	0000100000010000		2	0000100000010000		2	1000010001000100		3	1000010001000100		3
206	0000100100001000		2	0100001000100010		1	0000100100001000		2	0100001000100010		1
207	0000010010001000		2	0100001000010001		1	0000010010001000		2	0100001000010001		1
208	0000010001000100		2	0000010001000100		2	1000001000100100		3	1000001000100100		3
209	0000010000001000		2	0100000100010010		1	0000010000001000		2	0100000100010010		1
210	0000001000000100		3	0100000010000010		1	1000010000001000		3	0100000010000010		1
211	0000001000100100		3	0100000100100100		2	1000001001001000		3	0100000100100100		2
212	0000001001001000		3	0100000100000100		2	1000001000000100		3	0100000100000100		2
213	0000010000001000		3	0100000001000001		1	0000010000001000		3	0100000001000001		1
214	0000010001000100		3	0000010001000100		3	0100001000001000		3	0100001000001000		3
215	0000010010001000		3	0100000000100000		2	0000010010001000		3	0100000000100000		2
216	0000100000010000		3	0000100000010000		3	1001001000010000		3	1001001000010000		3
217	0000100010000100		3	0000100010000100		3	1001000100000100		3	1001000100000100		3
218	0000100100001000		3	0100000100000100		3	0000100100001000		3	0100000100000100		3
219	0001000000100000		3	0001000000100000		3	0100000100001001		1	0100000100001001		1
220	0001000100000100		3	0001000100000100		3	1001001000010000		2	1001001000010000		2
221	0001000100100100		3	0001000100100100		3	1001000100001000		2	1001000100001000		2
222	0001001000001000		3	0100000100100100		3	0001001000001000		3	0100000100100100		3
223	0001001001000100		3	0001001001000100		3	1001001000001000		3	1001001000001000		3
224	0010001000000100		3	0010001000000100		3	1000100000010000		3	1000100000010000		3
225	0010001000100100		3	0010001000100100		3	1001001001000010		1	1001001001000010		1
226	0010001001001000		3	0100001001000100		3	0010001001001000		3	0100001001000100		3
227	0010010000001000		3	0100100100000100		3	0010010000001000		3	0100100100000100		3
228	0010010001000100		3	0010010001000100		3	1001000100001000		3	1001000100001000		3
229	0010010010001000		3	0100000001000000		3	0010010010001000		3	0100000001000000		3
230	0010000001000000		4	0010000001000000		4	10010010000100001		1	10010010000100001		1

Table H.1 - Main Conversion Table (concluded)

8-bit byte	State 1			State 2			State 3			State 4		
	Code Word msb	lsb	Next State	Code Word msb	lsb	Next State	Code Word msb	lsb	Next State	Code Word msb	lsb	Next State
231	0000001001001001		1	0100100100100010		1	1001000100100010		1	0100100100100010		1
232	0000001000100010		1	0100100010000100		2	1001000100010001		1	0100100010000100		2
233	0000001000010001		1	0100100000010000		2	1001000010010010		1	0100100000010000		2
234	0000000100010010		1	0100000001000000		4	1001000010001001		1	0100000001000000		4
235	0000000100001001		1	01001001000010001		1	1001000001000010		1	01001001000010001		1
236	0000000010000010		1	0100100010010010		1	1001000000100001		1	0100100010010010		1
237	0000000001000001		1	0100100001000010		1	1000100100100001		1	0100100001000010		1
238	0010010000010010		1	0010010000010010		1	1000100010010001		1	0001000100100001		1
239	0010001000000010		1	0010001000000010		1	1001000010000100		3	1001000010000100		3
240	0010010000001001		1	0100100010000100		3	0010010000001001		1	0100100010000100		3
241	0010000100000001		1	0010000100000001		1	1001000010000100		2	1001000010000100		2
242	0001001000010010		1	0001001000010010		1	1000000010000000		4	1000000010000000		4
243	0001000100000010		1	0001000100000010		1	1000100001001001		1	1000100001001001		1
244	0001001000001001		1	0100100000100001		1	0001001000001001		1	0100100000100001		1
245	0001000010000001		1	0001000010000001		1	1000100000100010		1	1000100000100010		1
246	0000100100010010		1	0000100100010010		1	1000100000010001		1	1000100000010001		1
247	0000100010000010		1	0000100010000010		1	1000010000010010		1	1000010000010010		1
248	0000100100001001		1	0100010010010001		1	0000100100001001		1	0100010010010001		1
249	0000100001000001		1	0000100001000001		1	1000010000001001		1	1000010000001001		1
250	0000010010010010		1	0000010010010010		1	1000001000000010		1	1000001000000010		1
251	0000010001000010		1	0000010001000010		1	1000000100000001		1	1000000100000001		1
252	0000010010001001		1	0100010000100010		1	0000010010001001		1	0100010000100010		1
253	0000010000100001		1	0000010000100001		1	0100100010001001		1	0100100010001001		1
254	0000001001000100		2	0100010000010001		1	1001000000010000		2	0100010000010001		1
255	0000001000001000		2	0100001000010010		1	1000100100010000		2	0100001000010010		1

Table H.2 – Substitution Conversion Table

8-bit byte	State 1			State 2			State 3			State 4		
	Code Word msb	lsb	Next State	Code Word msb	lsb	Next State	Code Word msb	lsb	Next State	Code Word msb	lsb	Next State
0	000010010000000		4	000010010000000		4	0100100001001000		2	0100100001001000		2
1	000010010000000		4	000010010000000		4	0100100001001000		3	0100100001001000		3
2	000100100000000		4	000100100000000		4	0100100000001001		1	0100100000001001		1
3	000000100100000		4	0100010000000001		1	1000001000000000		4	0100010000000001		1
4	000000010010000		3	0100100000000010		1	1001000000000100		3	0100100000000010		1
5	000000001001000		3	0100001000000000		4	1001000000100100		3	0100001000000000		4
6	000000001001000		3	0100100000000100		2	1001000001001000		3	0100100000000100		2
7	000000001001000		2	0100000100000000		4	1001000000000100		2	0100000100000000		4
8	000000001001000		2	0100100010010000		3	1001000000100100		2	0100100010010000		3
9	000000010010000		2	0100100000100100		2	1001000001001000		2	0100100000100100		2
10	000001000100000		4	000001000100000		4	1001001001000000		4	1001001001000000		4
11	000010001000000		4	000010001000000		4	1000100001001000		3	1000100001001000		3
12	000100010000000		4	000100010000000		4	0100010001001000		3	0100010001001000		3
13	001000100000000		4	001000100000000		4	1000100000000100		3	1000100000000100		3
14	000000100010000		3	0100100000000100		3	1001000010010000		3	0100100000000100		3
15	000000010001000		3	0100100010010000		2	1001000100100000		3	0100100010010000		2
16	0000000010001000		3	0100001000000001		1	0100100000001000		3	0100001000000001		1
17	000000001000100		3	0100010000000010		1	0100100010001000		3	0100010000000010		1
18	000000001000100		2	0100100000100100		3	1001000010010000		2	0100100000100100		3
19	000000001000100		2	0100100100100000		3	1001000010010000		2	0100100100100000		3
20	000000010001000		2	0100100100100000		2	0100010001001000		2	0100100100100000		2
21	000000100010000		2	0100100000010010		1	0100100000001000		2	0100100000010010		1
22	0000010010000001		1	0000010010000001		1	1000100000100100		3	1000100000100100		3
23	0000100100000001		1	0000100100000001		1	1000100010010000		3	1000100010010000		3
24	0001001000000001		1	0001001000000001		1	0100010001000100		2	0100010001000100		2
25	0010010000000001		1	0010010000000001		1	1000100000000100		2	1000100000000100		2
26	000000001001001		1	0100010000000100		3	1000010000000001		1	0100010000000100		3
27	000000001001001		1	0100000100000001		1	1000100000000010		1	0100000100000001		1
28	0000000100100001		1	0100010000000100		2	1001000000001001		1	0100010000000100		2
29	0000001001000001		1	0100001000000010		1	1001000000010010		1	0100001000000010		1
30	0000100001000000		4	0000100001000000		4	1000100000100100		2	1000100000100100		2
31	0001000010000000		4	0001000010000000		4	1000100000100100		2	1000100000100100		2
32	0010000100000000		4	0010000100000000		4	0100010000001001		1	0100010000001001		1
33	0000010000100000		3	0000010000100000		3	0100100001001001		1	0100010000100000		1
34	0000001000010000		3	0100010000010010		1	1000100100100000		3	0100010000010010		1
35	0000000100001000		3	0100100000010001		1	1001000000001000		3	0100100000010001		1
36	0000000010000100		3	0100000010000000		4	1001000001000100		3	0100000010000000		4
37	0000010000100000		2	0000010000100000		2	1000001000000001		1	1000001000000001		1
38	0000000010000100		2	0100010000100100		3	1000100010010000		2	0100010000100100		3
39	0000000100001000		2	0100010000100100		2	1000100100100000		2	0100010000100100		2
40	0000001000010000		2	01001000000100010		1	1001000000001000		2	01001000000100010		1
41	0000010001000001		1	0000010001000001		1	1000010000000010		1	1000010000000010		1
42	0000000100000010		1	0000010010000010		1	1000000100000000		4	1000000100000000		4
43	0000100010000001		1	0000100010000001		1	1001000001000100		2	1001000001000100		2
44	0000100100000010		1	0000100100000010		1	1000100000001001		1	1000100000001001		1
45	0001000100000001		1	0001000100000001		1	1001000010001000		3	1001000010001000		3
46	0001001000000010		1	0001001000000010		1	1001000010001000		3	1001000010001000		3
47	0010001000000001		1	0010001000000001		1	1000100000010010		1	1000100000010010		1
48	0010010000000010		1	0010010000000010		1	0100010000001000		3	0100010000001000		3
49	0000000001000010		1	0100100010010001		1	10010000000010001		1	0100100010010001		1
50	0000000010001001		1	0100100001000100		3	1001000000100010		1	0100100001000100		3
51	0000000010010010		1	0100010001001000		3	1001000001001001		1	0100010001001000		3
52	0000000100010001		1	0100010001001000		2	10010000010010001		1	0100010001001000		2
53	0000000010010010		1	0100100001000100		2	10010000100100001		1	0100100001000100		2
54	0000001000100001		1	0100100100100001		1	1001001001000001		1	0100100100100001		1
55	0000001001000010		1	0100000100001000		3	01000010000001001		1	0100000100001000		3
56	0001000001000000		4	0001000001000000		4	1001001000100000		3	1001001000100000		3
57	0010000001000000		4	0010000001000000		4	1001000010001000		2	1001000010001000		2
58	0010010001001000		3	0010010001001000		3	1001000010001000		2	1001000010001000		2
59	0010010001001000		3	0100100100010000		2	0010010001001000		3	0100100100010000		2

Table H.2 - Substitution Conversion Table (concluded)

8-bit byte	State 1			State 2			State 3			State 4		
	Code Word msb	lsb	Next State	Code Word msb	lsb	Next State	Code Word msb	lsb	Next State	Code Word msb	lsb	Next State
60	0010010000100100		3	0010010000100100		3	1001001000100000		2	1001001000100000		2
61	00100100000000100		3	00100100000000100		3	0100001001001000		2	0100001001001000		2
62	0001001001001000		3	0100000010000001		1	0001001001001000		3	0100000010000001		1
63	0001001000100100		3	0001001000100100		3	0100001001001000		3	0100001001001000		3
64	00010010000000100		3	00010010000000100		3	010000100100001000		3	010000100100001000		3
65	0000100100100100		3	0000100100100100		3	0100100100001000		3	0100100100001000		3
66	00001001000000100		3	00001001000000100		3	10000100000000100		3	10000100000000100		3
67	0000100000100000		3	0000100000100000		3	1000010000100100		3	1000010000100100		3
68	00000100100000100		3	00000100100000100		3	1000010001001000		3	1000010001001000		3
69	0000010000010000		3	0000010000010000		3	1000010010010000		3	1000010010010000		3
70	00000010010000100		3	01000010000000100		2	10001000000001000		3	01000010000000100		2
71	0000001000001000		3	0100100000010000		3	1000100010001000		3	0100100000010000		3
72	0000000100100100		3	0100010001000100		3	1000100100010000		3	0100010001000100		3
73	00000001000000100		3	0100001000100100		3	10010000000010000		3	0100001000100100		3
74	0000010000010000		2	0000010000010000		2	1000100001000100		3	1000100001000100		3
75	0001001001001000		2	01000010000000100		3	0001001001001000		2	01000010000000100		3
76	00000100100000100		2	00000100100000100		2	010000100000001000		2	010000100000001000		2
77	0000100000100000		2	0000100000100000		2	01000010010001000		2	01000010010001000		2
78	0010010001001000		2	0100000100000010		1	0010010001001000		2	0100000100000010		1
79	00001001000000100		2	00001001000000100		2	0100100100001000		2	0100100100001000		2
80	0000100100100100		2	0000100100100100		2	10000100000000100		2	10000100000000100		2
81	00010010000000100		2	00010010000000100		2	1000010000100100		2	1000010000100100		2
82	0001001000100100		2	0001001000100100		2	1000010001001000		2	1000010001001000		2
83	00100100000000100		2	00100100000000100		2	1000010010010000		2	1000010010010000		2
84	0010010000100100		2	0010010000100100		2	1000100000001000		2	1000100000001000		2
85	0010010010010000		2	0010010010010000		2	01000010001001001		1	01000010001001001		1
86	00000001000000100		2	0100001000100100		2	1000100001000100		2	0100001000100100		2
87	0000000100100100		2	0100010001000100		2	1000100010001000		2	0100010001000100		2

Annex I (normative)

Optimum Power Control

I.1 Optimum recording power

The optimum recording powers P_{wo} , P_{eo} , and P_{co} depend on the disk, the drive and the recording speed.

The determination of values for P_{wo} , P_{eo} , and P_{co} for the actual disk/drive combination at the actual recording speed, is called the Optimum Power Control procedure (OPC procedure).

For a sensitive OPC procedure, the modulation versus power curve $m(P_w)$ shall be determined in a power range with sufficient variation of the modulation as a function of the power (slope $\gamma = (dm/dP_w)/(m/P_w)$ between about 0,5 and 2,0, see Figure I.1). The OPC procedure determines for the actual disk/drive combination and recording speed, the value P_{target} of the power for which $\gamma = \gamma_{target}$.

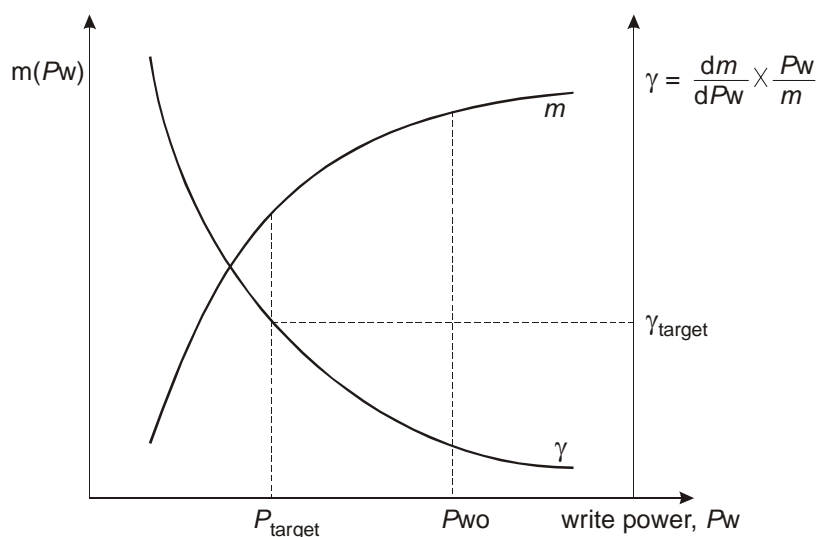

Figure I.1 – Modulation and Gamma functions versus power

To facilitate the OPC procedure, values are provided for P_{IND} , γ_{target} , ρ , ε_1 and ε_2 in the Physical format information. These values can be used as starting values in test recordings for the determination of the actual optimum P_{wo} , P_{eo} , and P_{co} .

The relevance of the parameters for determining P_{wo} , P_{eo} , and P_{co} is shown in the following formulas and Figure I.1:

- $m = I_{14} / I_{14H}$: the modulation amplitude of the HF signal
- $\gamma = (dm/dP_w) / (m/P_w)$: the normalized slope of the function $m(P_w)$
- P_{IND} : indicated estimate for P_{target} in the Physical format information
- $P_{target} = P_w(\text{at } \gamma_{target})$: the Write power at $\gamma = \gamma_{target}$
- ρ : the multiplication factor to obtain P_{wo}
- $P_{wo} = \rho \times P_{target}$: the optimum Write power
- ε_1 : the Erase / Write power ratio

ε_2 : the Cooling / Write power ratio
 $P_{e0} = \varepsilon_1 \times P_{w0}$: the optimum Erase power P_{e0}
 $P_{c0} = \varepsilon_2 \times P_{w0}$: the optimum Cooling power P_{c0}

I.2 Mathematical model for the modulation versus power function

To minimize the influences of random measuring errors and noise, the modulation versus power curve is approximated by the following function: $m(P_w) = m_{\max} \times (1 - \frac{P_{\text{thr}}}{P_w})$

with m_{\max} = max modulation (saturation level) and P_{thr} = threshold power.

The γ value calculated from this approximation is: $\gamma(P_w) = \frac{P_{\text{thr}}}{P_w - P_{\text{thr}}}$

and thus P_{target} is: $P_{\text{target}} = P_{\text{thr}} \times (1 + \frac{1}{\gamma_{\text{target}}})$

The function $f(P_w) = P_w \times m(P_w)$ will result in a straight line: $P_w \times m(P_w) = m_{\max} \times (P_w - P_{\text{thr}})$

By test recording random 8-to-16 modulated data with different Write powers P_{w_i} , using $P_{e_i} = \varepsilon_1 \times P_{w_i}$ and $P_c = \varepsilon_2 \times \rho \times P_{\text{IND}}$, the accompanying modulation values m_i are obtained.

By fitting the straight line $P_w \times m(P_w) = m_{\max} \times (P_w - P_{\text{thr}})$ to several points (P_{w_i} , $m_i \times P_{w_i}$), m_{\max} and P_{thr} for these points can be determined easily (one should realize that due to the limited accuracy of the model, m_{\max} can take values >1).

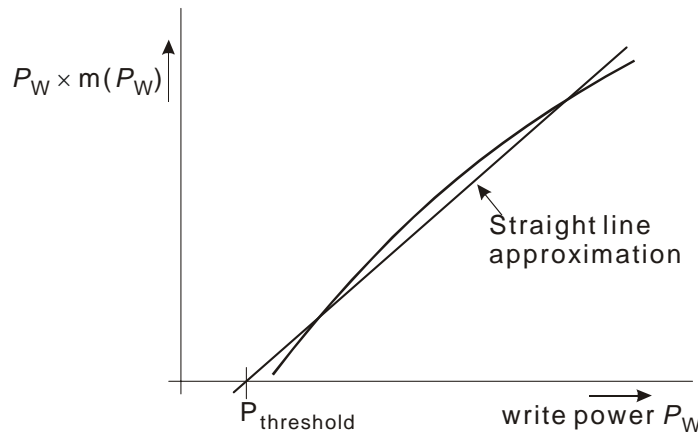

Figure I.2 – Modulation times Power versus Power function

I.3 Procedure for the determination of the media parameters

For determining the values for P_{IND} (indicated value for P_{target}), γ_{target} , ρ , ε_1 and ε_2 in the Physical format information, media manufacturers first have to find the optimum recording powers P_{w0} , P_{e0} and P_{c0} for their media. This can be done by making test recordings with several combinations of P_w , P_e and P_c and measuring the resulting recorded parameters according to 27.2.2 to 27.2.6, for recording at the maximum, reference, and minimum velocities, and for read-out at the Reference velocity. These measurements shall be made at 23 °C using the optical system in 9.2.

After choosing the combination of $P_w = P_{w0}$, $P_e = P_{e0}$ and $P_c = P_{c0}$, resulting in optimum recorded parameters, the ratios $\varepsilon_1 = P_{e0}/P_{w0}$ and $\varepsilon_2 = P_{c0}/P_{w0}$ are fixed.

NOTE

Because probably not all recorded parameters can be optimized independently, it is up to the media manufacturer to decide about the optimum combination of recorded parameters for his media.

In the next step the other parameters to be specified in the Physical format information have to be determined.

The media manufacturer shall make a choice for the indicated estimate of the target Write power P_{IND} .

The multiplication factor is $\rho = P_{WO}/P_{IND}$.

Before determining the γ_{target} value according to the following procedure, the tracks to be used for the measurements shall be erased once by irradiating these tracks using only the P_e power ($P_e = \varepsilon_1 \times \rho \times P_{IND}$).

Procedure for determination of the γ_{target} value:

After recording random 8-to-16 data with different Write powers P_{W_i} ranging from $0,9 \times P_{IND}$ to $1,1 \times P_{IND}$, using $P_{e_i} = \varepsilon_1 \times P_{W_i}$ and $P_c = \varepsilon_2 \times \rho \times P_{IND}$, the resulting modulations m_i are measured. Both the recordings and the measurement of m_i shall be performed on a reference drive according to 9.2 at $T=23$ °C.

Next the straight line fit according to I.2 is made to the obtained measuring points and γ_{target} can be

calculated:
$$\gamma_{target} = \frac{P_{thr}}{P_{IND} - P_{thr}}$$

Remark 1: The optimum recording powers shall be the powers that give optimum results after 10 DOW cycles.

Remark 2: Because the measurement of the modulation becomes rather inaccurate at low values, the power ranges (and thus P_{IND}) should be chosen such that the modulation at the lowest power value is > 30 %.

I.4 Example OPC procedure for drives

By test recording random 8-to-16 data with different Write powers P_{W_i} , using $P_{e_i} = \varepsilon_1 \times P_{W_i}$ and $P_c = \varepsilon_2 \times \rho \times P_{IND}$, the accompanying modulation values m_i are obtained.

By fitting the straight line: $P_w \times m(P_w) = m_{max} \times (P_w - P_{thr})$ to several points (P_{W_i} , $m_i \times P_{W_i}$), m_{max} and P_{thr} for these points can be determined easily.

Now P_{target} for a specific power range can be calculated (see I.2) with the help of γ_{target} given in the Physical format information.

Because the mathematical model is only a first order approximation, an interpolation or iteration procedure might be needed to come to a sufficiently accurate value of P_{target} .

The following interpolation procedure is given as an example:

- 2 center power values are chosen for a straight line fit:
 $P_{fit,1} = 0,95 \times P_{IND}$ and $P_{fit,2} = 1,05 \times P_{IND}$,
- from the measured modulation values m_i at powers P_{W_i} ranging from $0,9 \times P_{fit,1}$ to $1,1 \times P_{fit,1}$, the accompanying value of $P_{target,1}$ is determined,
- from the measured modulation values m_i at powers P_{W_i} ranging from $0,9 \times P_{fit,2}$ to $1,1 \times P_{fit,2}$, the accompanying value of $P_{target,2}$ is determined,
- now P_{target} is calculated from the intersection of the line through the points ($P_{target,1}$, $P_{fit,1}$) and ($P_{target,2}$, $P_{fit,2}$) with the line represented by $P_{target} = P_{fit}$,

$$\text{resulting in: } P_{target} = \frac{P_{target,2} \times P_{fit,1} - P_{target,1} \times P_{fit,2}}{P_{target,2} - P_{target,1} - P_{fit,2} + P_{fit,1}}$$

the final accuracy, if needed, can be improved by a number of iterations.

Now P_{wo} , P_{eo} and P_{co} are obtained by (ρ , ε_1 , ε_2 as given in the Physical format information):

$$P_{wo} = \rho \times P_{\text{target}}$$

$$P_{eo} = \varepsilon_1 \times P_{wo}$$

$$P_{co} = \varepsilon_2 \times P_{wo}$$

Remark 3: The OPC procedure should be performed in an area on the disk that is specially reserved for this purpose: The Drive Test Zone or the Disk Test Zone. It is recommended to use for each OPC procedure a randomly chosen location in these areas.

To increase the reliability of the OPC results it is strongly recommended to initialize the Drive Test Zones and the Disk Test Zones before using these areas by recording them with all (00) data using the following write power settings derived from

the Physical format information: $P_w = \rho \times P_{\text{IND}}$, $P_e = \varepsilon_1 \times P_w$ and $P_c = \varepsilon_2 \times P_w$, or by using some optimum write power settings determined by the drive.

Remark 4: Before the OPC procedure, the tracks to be used (also on blank disks), shall be erased by irradiating the tracks using only the P_e power ($P_e = \varepsilon_1 \times \rho \times P_{\text{IND}}$). After the OPC procedure the used tracks shall be overwritten with nominal power using Sectors with all Main Data set to (00) and correct address information (ID + IED).

Remark 5: Within the speed range of one and the same write strategy, the ratio $\frac{P_p}{\rho \times P_{\text{IND}}}$ determined

at one linear velocity (v_1) using this OPC method, can be used to determine the optimum power, P_w , at an other linear velocity (v_2), based on the indicated power P_{IND} and the multiplication factor ρ , of

that other velocity:
$$P_{p_{v2}} = \rho_{v2} \times P_{\text{IND}_{v2}} \times \frac{P_{p_{v1}}}{\rho_{v1} \times P_{\text{IND}_{v1}}}$$

I.5 Media margins under different overwrite conditions

To guarantee correct data interchange in case of overwriting at different speeds, the disk shall be tested in the following way:

- the blank disk is first recorded one time at 3,49 m/s (1x) with the optimum Write powers as determined by the OPC procedure as described in this Annex,
- the recorded information is overwritten one time at 13,95 m/s (4x) with 0,9× the optimum Write powers as determined by the OPC procedure as described in this Annex,
- as a result the total number of PI errors before correction in any 8 consecutive ECC Blocks shall not exceed 280 (see 29.2).

As well the recordings as the measurements shall be performed with a Reference drive as defined in Clause 9 and Annex E.

I.6 Media margins at non-optimum Write power

To create some margins for practical accuracy requirements for drive implementations, the disk should allow for some deviations of the Write power from the optimum values.

For actual Write powers P_w in the range $0,85 \times P_{wo}$ to $1,10 \times P_{wo}$, and $P_e = \varepsilon_1 \times P_w$ and $P_c = \varepsilon_2 \times P_w$, with ε_1 and ε_2 according to the nominal values as indicated in 14.4.2, the disk shall fulfill all specifications at 10 DOW cycles.

Additionally the jitter shall stay below 10% for any number of overwrites up to 500 DOW cycles when recording with P_{wo} .

It is recommended that the disk can be overwritten at least 1 000 times, while all parameters stay within their specified ranges.

Annex J (normative)

Logical to Physical address translation

The Logical to Physical address translation might be depending on an applied Defect Management system. Consequently the physical addresses of the start and the ending of the Logical Sector Numbering can be different from the values specified in Clause 20.



Annex K (informative)

Measurement of the groove wobble amplitude

K.1 Relation between normalized wobble signal and wobble amplitude

The wobble amplitude in nm cannot easily be measured directly. However, it can be derived from the normalized wobble signal. The theoretical results for such a derivation are given below.

The peak value of the wobble signal I_W can be seen as:

$$I_{Wp} = A \times \sin(2 \times \pi \times a / p)$$

where:

a = wobble amplitude in nm

p = track pitch of the radial error signal

A = the peak value of the radial error signal

In Figure K.1 the parameters a , p , A and I_{Wp} are shown. The groove has a peak displacement of ' a ' (wobble amplitude) from the averaged centre of the groove to the actual centre of the groove. The normalized wobble signal can now be defined as:

$$\frac{I_{Wpp}}{(I_1 - I_2)_{pp}} = \frac{2 \times I_{Wp}}{2 \times A} = \sin\left(2 \times \pi \times \frac{a}{p}\right)$$

where

$$(I_1 - I_2)_{pp} = 2 \times A$$

The wobble signal I_W is not only dependent on the wobble amplitude a , but also the track pitch p . Due to normalization, dependencies on groove geometry, spot shape and optical aberrations have been eliminated.

K.2 Tolerances of the normalized wobble signal

From the above formulae for the normalized wobble signal, the tolerances as given in 28.4 can be converted to nm for a given track pitch of ' p ' = 0,74 μm .

Lower limit: 0,20 corresponds to a = 24 nm.

Upper limit: 0,30 corresponds to a = 36 nm.

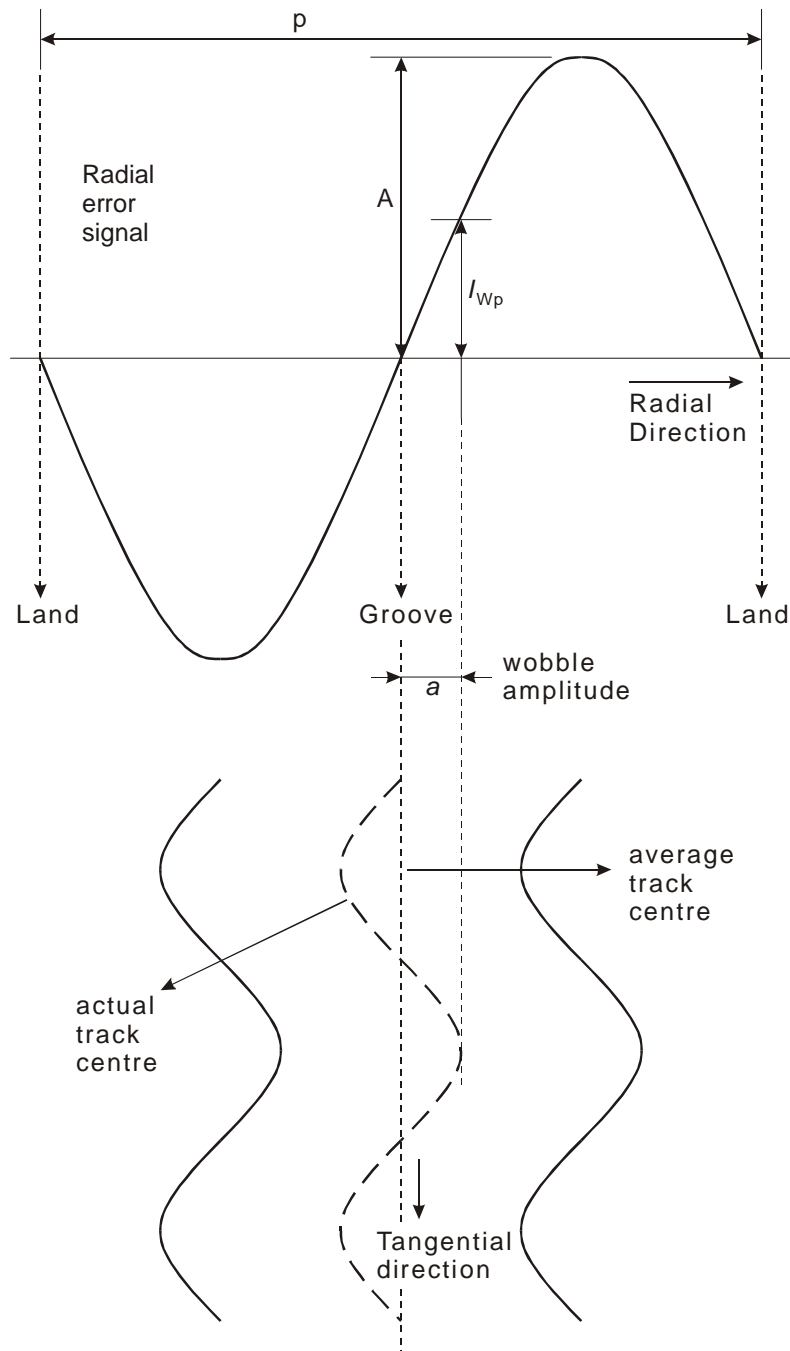

Figure K.1 - Wobble amplitude of the groove

Annex L (informative)

Transportation

L.1 General

As transportation occurs under a wide range of temperature and humidity variations, for differing periods, by many methods of transport and in all parts of the world, it is not practical to specify mandatory conditions for transportation or for packaging.

L.2 Packaging

The form of packaging should be agreed between sender and recipient or, in absence of such an agreement, is the responsibility of the sender. It should take into account the following hazards.

L.2.1 Temperature and humidity

Insulation and wrapping should be designed to maintain the conditions for storage over the estimated period of transportation.

L.2.2 Impact loads and vibrations

- a) Avoid mechanical loads that would distort the shape of the disk.
- b) Avoid dropping the disk.
- c) Disks should be packed in a rigid box containing adequate shock-absorbent material.
- d) The final box should have a clean interior and a construction that provides sealing to prevent the ingress of dirt and moisture.

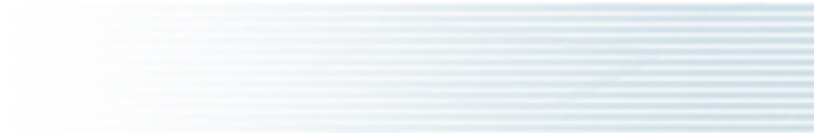

Annex M (informative)

Defect Management and Physical Formatting

To improve the efficiency and data reliability in general storage applications, the +RW disks which are in conformance with this Ecma Standard can be combined with a system for Background Formatting and Defect Management. An example of such a system is the so-called Mount Rainier Defect Management described in the following document:

DVD+MRW Defect Management & Physical Formatting,
which can be obtained from Royal Philips Electronics.

NOTE

For more information see URL <http://www.licensing.philips.com>



Annex N (informative)

Video Content Protection System

DVD recorders, especially those equipped with digital interfaces, make it possible to produce perfect replicas of video content. To prevent unauthorized copying and/or redistribution of such video data, this data should be protected by some encryption system. An example of a protection system for video recorded in the DVD+R/+RW Video Format is the so-called Video Content Protection System described in the following document.

VCPS: Video Content Protection System for the DVD+R/+RW Video Recording Format, System Description,
which can be obtained from Royal Philips Electronics.

NOTE

For more information see URL <http://www.licensing.philips.com>



Annex O (informative)

How to use the Physical format information in ADIP

To fully exploit the Physical format information in the ADIP, the following rules are given as a recommended guideline (see also the flowchart in Figure O.1).

Drives should read the ADIP and check for the following information:

- 1) check the Disk Category in byte 0
 - ⇒ determine if the disk is a +R or +RW disk; also check if the disk is a single layer or a dual layer disk; use the related standard (see clause 3) for further interpretations.

Drives shall respect the Disk Application Code:

- 2) check the Disk Application Code in byte 17
 - ⇒ if the drive is not able to obey the rules related to a specific Disk Application Code, the drive shall block the disk for recording.

If the drive can do "media recognition" (i.e. the drive can uniquely determine the manufacturer and the type of the disk and has optimum sets of write parameters for certain disks in its memory):

- 3) check for Disk Manufacturer and Media Type ID (bytes 19 to 29)
 - ⇒ choose the optimum write strategy for this specific media from the drive's memory.

If the drive fails to recognize the media:

- 4) check the version number in byte 0
 - ⇒ if the version number is unknown: do not use the contents of bytes 32 to 63,
 - ⇒ if the version number is known: interpret bytes 32 to 63 according to the correct book version.
- 5) check byte 18 for the presence of Extended Information blocks
 - ⇒ if no EI blocks are present: only basic write strategy is available.

If EI blocks present:

- 6) check the Format number in each present EI block
 - ⇒ if the Format number is unknown: do not use the contents of the related EI block,
 - ⇒ if the Format number is known: interpret the EI block according to the correct book version.

Now the drive can choose the best fitting recording speed and write strategy from the available options:

- ⇒ basic write strategy (1x ~ 2,4x) as defined in bytes 32 to 63,
- ⇒ write strategy from one of the known EI blocks,
- ⇒ for each available write strategy the drive should check the actually supported recording speeds indicated in the related bytes (supported recording speeds can be adapted in future versions of this document).

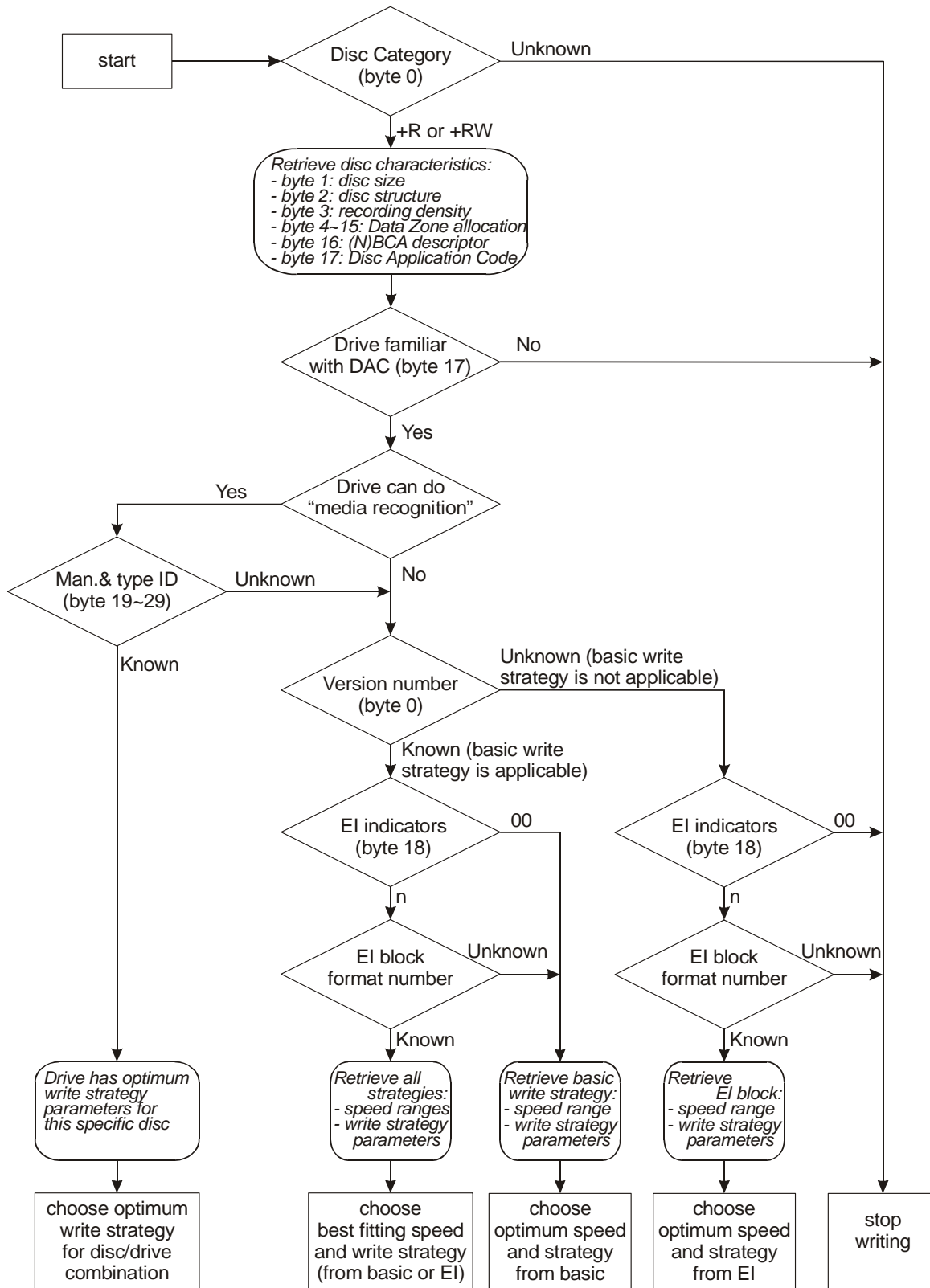

Note: in future more than one EI block can exist on one disc!

Figure O.1 - Flowchart showing the use of Physical format information in ADIP

Annex P (informative)

Values to be Implemented in Existing and Future Specifications

The values for bytes which this Ecma Standard specifies are related to ReWritable disks which are in conformance with this Ecma Standard, viz. +RW Format disks. It is expected that other categories of disks will be standardized in future. It is therefore recommended that the following values be used for these other disks. Further possible bit patterns are intended for future standardization.

All standards are subject to revisions, so the information in this Annex can be subject to changes. Therefore it is recommended to check this information against the most recent edition of the indicated standards.

Identification Data

Bit b_{31}	shall be set to ZERO, indicating CLD format ONE, indicating Zoned format
Bit b_{30}	shall be set to ZERO, indicating pit tracking ONE, indicating groove tracking
Bit b_{29}	shall be set to ZERO if the reflectance is greater than 40 % with a PBS optical system ONE if the reflectance is less than 40 % with a PBS optical system
Bit b_{28}	Reserved, shall be set to ZERO
Bits b_{27} to b_{26}	shall be set to ZERO ZERO in the Data Zone ZERO ONE in the Lead-in Zone ONE ZERO in the Lead-out Zone ONE ONE in the Middle Zone
Bit b_{25}	shall be set to ZERO, indicating read-only data ONE, indicating other than read-only data
Bit b_{24}	shall be set to ZERO on Layer 0 of DL disks, ONE on Layer 1 of DL disks, ZERO on SL disks.
Bits b_{23} to b_0	shall specify the Physical Sector Number

Physical format information in the Lead-in Zone

Byte 0 - Disk Category and Version Number

Bits b_7 to b_4 shall specify the Disk Category

- if set to 0000, they indicate a DVD - Read-Only disk
- if set to 0001, they indicate a DVD Rewritable disk (DVD-RAM)
- if set to 0010, they indicate a DVD-Recordable disk (DVD-R)
- if set to 0011, they indicate a DVD Re-recordable disk (DVD-RW)
- if set to 1001, they indicate a +RW disk
- if set to 1010, they indicate a +R Single Layer disk
- if set to 1110, they indicate a +R Dual Layer disk

Bits b_3 to b_0 shall specify the Version Number. Together with b_7 to b_4 they specify the related document.

- if b_7 to b_4 set to 0000 and b_3 to b_0 set to 0001, they specify ECMA Standard 267/268
- if b_7 to b_4 set to 0001 and b_3 to b_0 set to 0001, they specify ECMA Standard 272
- if b_7 to b_4 set to 0001 and b_3 to b_0 set to 0110, they specify ECMA Standard 330
- if b_7 to b_4 set to 0010 and b_3 to b_0 set to 0001, they specify ECMA Standard 279
- if b_7 to b_4 set to 0011 and b_3 to b_0 set to 0010, they specify ECMA Standard 338
- if b_7 to b_4 set to 1001 and b_3 to b_0 set to 0001, they specify ECMA Standard 274
- if b_7 to b_4 set to 1001 and b_3 to b_0 set to 0010, they specify this document
- if b_7 to b_4 set to 1001 and b_3 to b_0 set to 0011, they specify ECMA Standard 371
- if b_7 to b_4 set to 1010 and b_3 to b_0 set to 0001, they specify ECMA Standard 349
- if b_7 to b_4 set to 1110 and b_3 to b_0 set to 0001, they specify ECMA Standard 364

Byte 1 - Disk size and maximum transfer rate

Bits b_7 to b_4 shall specify the disk size

- if set to 0000, they specify a 120 mm disk
- if set to 0001, they specify an 80 mm disk

Bits b_3 to b_0 shall specify the maximum transfer rate

- if set to 0000, they specify a maximum transfer rate of 2,52 Mbits/s
- if set to 0001, they specify a maximum transfer rate of 5,04 Mbits/s
- if set to 0010, they specify a maximum transfer rate of 10,08 Mbits/s
- if set to 1111, they specify no maximum transfer rate is specified.

Byte 2 - Disk structure

Bit b_7 shall be set to ZERO.

Bits b_6 and b_5 shall specify the disk Type

- if set to 00, they specify a single recording layer per side
- if set to 01, they specify two recording layers per side

Bit b_4 shall specify the track path

- if set to ZERO, it specifies PTP on Dual Layer disks or a Single Layer disk,
- if set to ONE, it specifies OTP on Dual Layer disks

Bits b_3 to b_0 specify the layer type

Bit b_3 shall be set to ZERO

Bit b_2 if set to ZERO, shall specify that the disk does not contain re-writable Data Zones
ONE, shall specify that the disk contains re-writable Data Zones

Bit b_1 if set to ZERO, shall specify that the disk does not contain recordable Data Zones
ONE, shall specify that the disk contains recordable Data Zones

Bit b_0 if set to
ZERO, shall specify that the disk does not contain embossed Data Zones
ONE, shall specify that the disk contains embossed Data Zones

Byte 3 - Recording density

Bits b_7 to b_4 shall specify the average Channel bit length

if set to 0000, they specify 0,133 μm

if set to 0001, they specify 0,147 μm

if set to 0010, they indicate that this average length is in the range 0,205 μm to 0,218 μm

if set to 1000, they specify 0,176 37 μm

Bits b_3 to b_0 shall specify the average track pitch

if set to 0000, they indicate a track pitch of 0,74 μm

if set to 0001, they indicate a track pitch of 0,80 μm



