

Standard ECMA-378

1st Edition / May 2007

**Information Interchange on
Read-Only Memory
Holographic Versatile Disc
(HVD-ROM) – Capacity:
100 Gbytes per disk**

Standard



is the registered trademark of Ecma International



COPYRIGHT PROTECTED DOCUMENT

Standard
ECMA-378
1st Edition / May 2007

**Information Interchange on
Read-Only Memory
Holographic Versatile Disc
(HVD-ROM) –
Capacity: 100 Gbytes per
disk**

NOTIFICATION AND DISCLAIMER

Ecma international draws attention to the possibility that the practice, use or implementation of this Ecma Standard or of parts thereof may involve the use of one or more Intellectual Property Rights, in particular such as a patent or a patent application.

Ecma International takes no position concerning the existence, evidence, scope of protection, validity or applicability of any or all of such Intellectual Property Rights, whether asserted by Ecma International members or others outside of the Ecma Standard development process worldwide. In particular, Ecma International does not identify any or all of such Intellectual Property Rights, does not evaluate the scope of protection and validity of any or all of such Intellectual Property Rights, and does not evaluate the question whether the practice, use or implementation of this Ecma Standard or of parts thereof does or does not make use of any or all of such Intellectual Property Rights. Furthermore, Ecma International does not assume – under any circumstances – any responsibility in this respect.

Ecma International informs that as of the date of approval of this Standard, Ecma International has received notice of Intellectual Property Rights. Implementers and users are cautioned that this may not represent the latest information which is available and are therefore strongly urged to consult the Ecma International website for further information.

Introduction

In October 2004 a group of Companies, known as the HVD Alliance, proposed to Ecma to develop a standard for the first member of a family of holographic media. Ecma adopted this project and Ecma Technical Committee TC44 was established for the standardization of holographic media.

This Standard ECMA-378 is the first standard for a read-only holographic disk.

This Ecma Standard has been adopted by the General Assembly in May 2007.

Table of contents

Section 1	- General	1
1	Scope	1
2	Conformance	1
2.1	Holographic disk	1
2.2	Generating system	1
2.3	Receiving system	1
2.4	Compatibility statement	1
3	References	2
4	Definitions	2
4.1	asymmetry	2
4.2	case	2
4.3	clamping zone	2
4.4	cover layer	2
4.5	Data Page	2
4.6	Data Page hologram	2
4.7	Data Page hologram pitch	2
4.8	data reading beam	2
4.9	data reading energy	2
4.10	disk reference plane	2
4.11	entrance surface	2
4.12	Error Correction Code (ECC)	3
4.13	format	3
4.14	hologram track	3
4.15	holographic disk	3
4.16	holographic storage layer	3
4.17	packet	3
4.18	pit	3
4.19	pit layer	3
4.20	pit track	3
4.21	pixel	3
4.22	Read Only Memory (ROM) disk	3
4.23	Reed-Solomon code	3
4.24	Reference Drive	3

4.25	Reference Pattern	3
4.26	Specific Disk Information (SDI)	3
4.27	spindle	3
4.28	Sub-Page	3
4.29	substrate	4
4.30	symbol	4
4.31	Sync Mark	4
4.32	track	4
4.33	track pitch	4
4.34	tracking/addressing beam	4
4.35	tracking/addressing reading power	4
4.36	User data Zone	4
4.37	zone	4
5	Conventions and notations	4
5.1	Representation of numbers	4
5.2	Names	4
6	Acronyms	5
7	General description	5
8	General requirement	5
8.1	Environments	5
8.1.1	Operating environment	5
8.1.2	Storage environment	5
8.1.3	Transportation	6
8.2	Temperature shock	6
8.3	Safety requirements	6
8.4	Flammability	6
9	Reference Drive	6
9.1	Optical system	6
9.2	Tracking and Addressing Channel	8
9.2.1	Tracking/addressing beam	8
9.2.2	Tracking/Addressing/SDI signals	8
9.3	Data Holographic Reading Channel	8
9.3.1	Reading beam	8
9.3.2	Reference Pattern	9
9.3.3	Photodetector array	10
9.4	Conditions for measuring the operational signals	10
9.4.1	Tracking, Addressing, Specific Disk Information	10

9.4.2	Data reading	11
9.4.3	Normalized servo transfer functions	11
9.4.4	Rotation of the disk	11
Section 2 - Mechanical and physical characteristics		11
10	Dimensional, mechanical, and physical characteristics of the disk	11
10.1	General description of the disk	11
10.2	Reference axis and plane of the disk	12
10.3	Dimensions of the disk	12
10.4	Clamping Zone	12
10.5	Mechanical characteristics	13
10.5.1	Material	13
10.5.2	Mass	13
10.5.3	Moment of inertia	13
10.5.4	Imbalance	13
10.5.5	Axial deflection	13
10.5.6	Axial acceleration	13
10.5.7	Radial runout	13
10.5.8	Radial acceleration	13
10.5.9	Tilt	14
10.6	Optical characteristics	14
10.6.1	Substrate	14
10.6.2	Metadata layer	14
10.6.3	Gap layer 1	14
10.6.4	Dichroic mirror layer	14
10.6.5	Gap layer 2	14
10.6.6	Holographic storage layer	14
10.6.7	Cover layer	14
10.6.8	Thicknesses of the stack of layers	14
10.6.9	Birefringence of the stack of layers	16
11	Interface between disk and drive	16
11.1	Clamping method	16
11.2	Tapered cone for disk clamping	16
11.3	Clamping force	16
Section 3 - Format of information		16
12	General description	16
13	Tracking and addressing information format / Specific Disk Information format	16
13.1	Pit track pitch	16

13.2	Pit track format	17
13.2.1	Sector	17
13.2.2	Header	17
13.2.3	Sync	22
13.2.4	Tracking data	22
13.2.5	Land	22
13.3	Specific Disk Information (SDI)	22
13.3.1	SDI bytes encoding	23
13.4	Radial alignment	23
14	Data information format	23
14.1	Data Page holograms layout in the storage layer	23
14.1.1	Radial Data Page hologram pitch	23
14.1.2	Data Page hologram layout within tracks	24
14.1.3	Zones / Tangential Data Page hologram pitch / Number of Data Page holograms per Peapod	24
14.2	Data Page encoding	25
14.2.1	User data	25
14.2.2	Header	26
14.2.3	Footer	26
14.2.4	ECC	26
14.2.5	Scrambling	27
14.3	Digital to image conversion	27
14.3.1.	8 bits to 16 bits conversion	27
14.3.2	Symbol/Sub-Page	28
14.4	Data Page hologram - Reference Pattern	30
15	Division of the Formatted Zone	30
15.1	General description of the Formatted Zone	30
15.2	Content/usage of the Formatted Zone	30
15.2.1	Zone 0 – Lead-in Zone / Buffer Zone 1 / Test Zone / Buffer Zone 2	31
15.2.2	Zones 1 to 15 - User data Zone	31
15.2.3	Zone 16 - Lead-out Zone	31
Section 4	Characteristics of the tracking/addressing and SDI information	32
16	Method of testing	32
16.1	Environment	32
16.2	Use of the Reference Drive	32
16.2.1	Optics and mechanics	32
16.2.2	Tracking/addressing beam power	32
16.2.3	Tracking requirements	32
16.3	Definition of signals	32

17	Signal requirements	33
17.1	Reflectivity	33
17.2	Normalized Push Pull signal	33
17.3	Modulation	34
17.4	Resolution	34
17.5	4Ttop modulation	34
17.6	Asymmetry	34
17.6.1	Asymmetry (4T - 2T)	34
17.6.2	Asymmetry (16T - 4T)	34
17.7	Jitter	34
17.8	Phase depth	34
Section 5 - Characteristics of user data		35
18	User data – Method of testing	35
18.1	Environment	35
18.2	Reference Drive	35
18.2.1	Optics and mechanics	35
18.2.2	Tracking/addressing reading power	35
18.2.3	Data reading energy	35
18.2.4	Tracking requirements	35
18.2.5	Relative positioning of the focus of the data reading beam and the tracking/addressing beam	35
18.2.6	Data detection for testing purposes	35
19	Minimum quality of a Data Page	35
19.1	Reading energy damage	36
20	Data interchange requirements	36
20.1	Tracking	36
20.2	Stored data	36
20.3	User-read data	36
Annex A (normative) Measurement of light reflectance		37
Annex B (normative) Measurement of birefringence		39
Annex C (normative) Tapered cone for disk clamping		43
Annex D (normative) Specific Disk Information		45
Annex E (normative) ECC		47

Annex F (normative)	16 bits to Symbols conversion look-up table	51
Annex G (normative)	Finalizing data	67
Annex H (normative)	Tracking/Addressing and Data Reading Channels characteristics	69
Annex I (normative)	Asymmetry measuring definition	73
Annex J (informative)	Office environment	75
Annex K (informative)	Transportation	77
Annex L (informative)	Track deviation measurement	79

Section 1 - General

1 Scope

This Ecma Standard specifies the mechanical, physical, and optical characteristics of a holographic disk that employs holographic storage to enable data interchange between such disks.

The disk is of the ROM (Read Only Memory) type providing for stored data to be read a multiplicity of times.

The 120 mm diameter disk has a nominal capacity of 100 Gigabytes.

This Ecma Standard specifies

- the conditions for conformance testing and the Reference Drive;
- the environments in which the disks are to be operated and stored;
- the mechanical, physical and dimensional characteristics of the disk so as to provide mechanical interchangeability between data processing systems;
- the format of the information on the disk, including the physical disposition of the tracks and data pages, the error correction codes, the modulation methods used;
- the characteristics of the embossed information on the disk;
- the characteristics of the holographic information on the disk;
- the minimum quality of stored data on the disk, enabling data processing systems to read data from the disk.

This Ecma Standard provides for interchange between holographic disk drives. Together with a standard for volume and file structure, it provides for full data interchange between data processing systems. The disks specified by this Ecma Standard may be enclosed in cases according to Standard ECMA-375 as specified therein.

2 Conformance

2.1 Holographic disk

A holographic disk shall be in conformance with this Ecma Standard if it meets all mandatory requirements specified therein.

2.2 Generating system

A system generating a holographic disk for interchange shall be in conformance with this Ecma Standard if it meets the mandatory requirements of this Ecma Standard.

2.3 Receiving system

A system receiving a holographic disk for interchange shall be in conformance with this Ecma Standard if it is able to process any stored data on the disk according to 2.1.

2.4 Compatibility statement

A claim of conformance with this Ecma Standard shall include a statement listing any other disk standard supported by the system for which conformance is claimed. This statement shall specify the number of the standard(s), including, where appropriate, the disk type(s), and whether support includes reading only or both reading and writing.

3 References

The following Standards contain provisions, which through reference in this text, constitute provisions of this Ecma Standard. At the time of publication, the edition indicated was valid. All standards are subjected to revision, and parties to agreements based on this Ecma Standard are encouraged to investigate the possibility of applying the most recent edition of the following Standards.

ECMA-287 (2002)	Safety of electronic equipment
ECMA-328 (2001)	Detection and measurement of chemical emissions from electronic equipment
ECMA-375 (2006)	Case for 120 mm HVD-ROM disks

4 Definitions

For the purpose of this Ecma Standard the following definitions apply.

4.1 **asymmetry**

The deviation between the centre levels of signals generated by two distinct repeating pit and land patterns.

4.2 **case**

The housing that may protect the disk.

4.3 **clamping zone**

The annular part of the disk within which the clamping force is applied by the clamping device.

4.4 **cover layer**

A transparent layer of the disk, which protects other layers.

4.5 **Data Page**

A two-dimensional representation of data.

4.6 **Data Page hologram**

A hologram storing a Data Page.

4.7 **Data Page hologram pitch**

The distance between adjacent Data Page hologram centres in the holographic storage layer, measured in the radial direction (radial Data Page hologram pitch) or in the tangential direction (tangential Data Page hologram pitch).

4.8 **data reading beam**

The beam used to reconstruct the image recorded in the stored hologram.

4.9 **data reading energy**

The optical energy, incident at the entrance surface of the disk, of the hologram reading beam.

4.10 **disk reference plane**

A plane defined by the perfectly flat annular surface of an ideal spindle onto which the clamping zone of the disk is clamped, and which is normal to the axis of rotation.

4.11 **entrance surface**

The surface of the disk onto which the optical beams first impinge.

4.12 Error Correction Code (ECC)

An error-detecting code designed to correct certain kinds of errors in data.

4.13 format

The arrangement or layout of information on the disk. The annular area on the disk bearing the format is the Formatted Zone.

4.14 hologram track

Track in the storage layer that contains or may contain holograms.

4.15 holographic disk

A disk that will accept and retain information in a holographic storage layer.

4.16 holographic storage layer

A layer of the disk in which data is stored in the form of holograms. The holographic storage layer may actually consist of a multiple layer stack of different materials or composite materials.

4.17 packet

A group of bytes/bits processed together during data encoding/decoding.

4.18 pit

A local depression used to store data information.

4.19 pit layer

A layer of the disk bearing pits.

4.20 pit track

Track in the pit layer that contains pits.

4.21 pixel

The smallest independent element of an image.

4.22 Read Only Memory (ROM) disk

A disk which can be only read.

4.23 Reed-Solomon code

An error detection and/or correction code which is particularly suited to the correction of errors that occur in bursts or are strongly correlated.

4.24 Reference Drive

A drive with well defined properties used to test conformance to the Standard of the read parameters of the disk.

4.25 Reference Pattern

A light pattern used to generate the Data Page hologram, and reconstitute its image content.

4.26 Specific Disk Information (SDI)

Manufacturing information recorded on the disk.

4.27 spindle

The part of the disk drive that contacts the disk.

4.28 Sub-Page

A subdivision of a Data Page.

4.29 substrate

A layer of the disk provided for mechanical support of other layers.

4.30 symbol

An encoding data unit of Data Page.

4.31 Sync Mark

A pattern of data pixels used for synchronization of Page data.

4.32 track

A path that is followed by the focus of an optical beam during exactly one revolution of the disk.

4.33 track pitch

The distance between adjacent tracks centrelines, measured in a radial direction.

4.34 tracking/addressing beam

The beam used to read the tracking/addressing information.

4.35 tracking/addressing reading power

The optical power, incident at the entrance surface of the disk, of the tracking/addressing beam.

4.36 User data Zone

The zone of the disk intended for storage of user data.

4.37 zone

An annular area of the disk.

5 Conventions and notations

5.1 Representation of numbers

A measured value is rounded off to the least significant digit of the corresponding specified value. For instance, it implies that a specified value of 1,26 with a positive tolerance of + 0,01 and a negative tolerance of - 0,02 allows a range of measured values from 1,235 to 1,275.

Numbers in decimal notations are represented by the digits 0 to 9.

Numbers in hexadecimal notation are represented by the hexadecimal digits 0 to 9 and A to F in parentheses.

The setting of bits is denoted by ZERO and ONE.

Numbers in binary notations and bit patterns are represented by strings of digits 0 and 1, with the most significant bit shown to the left.

Negative values of numbers in binary notation are given as Two's complement.

In each field the data is recorded so that the most significant byte (MSB), identified as Byte 0, is recorded first and the least significant byte (LSB) last. In a field of $8n$ bits, bit $b_{(8n-1)}$ shall be the most significant bit (msb) and bit b_0 the least significant bit (lsb). Bit $b_{(8n-1)}$ is recorded first.

A binary digit which can be set indifferently to ZERO or to ONE is represented by "x".

5.2 Names

The names of entities, e.g. specific fields, areas, zones, etc. are given a capital initial.

6 Acronyms

ECC	Error Correction Code
HVD	Holographic Versatile Disc
HVD R	Holographic Versatile Disc Recordable
HVD ROM	Holographic Versatile Disc Read Only Memory
LDPC	Low Density Parity Check (code)
LSB	Least Significant Byte
lsb	least significant bit
MSB	Most Significant Byte
msb	most significant bit
SDI	Specific Disk Information
Sync	Synchronization

7 General description

The holographic disk, which is the subject of this Ecma Standard, is made from a substrate bearing a stack of layers.

Data is stored onto the disk as holographic fringes in the volume of the storage layer. Data can be read by a focused optical beam.

A layer of the disk contains tracking/addressing data carried by embossed pits. This data can be read using the diffraction of a focused optical beam by the pits.

The beams access the storage and pit layers through the transparent cover layer of the disk.

8 General requirement

8.1 Environments

8.1.1 Operating environment

The operating environment is the environment where air immediately surrounding the holographic disk has the following properties:

Temperature	35 °C ± 2 °C
Atmospheric pressure	60 kPa to 106 kPa
Relative humidity	20 % to 80 %
Absolute humidity	25 g/m ³ max.
Air cleanliness	Office environment (see Annex J)

No condensation on the holographic disk shall occur. If a holographic disk has been exposed during storage and/or transportation to a condition outside the above values, before use the disk shall be conditioned in the operating environment for a time at least equal to the period during which it has been out of the operating environment, up to a maximum of 24 h.

8.1.2 Storage environment

The holographic disk without any protective enclosure shall not be stored in an environment outside the range allowed for storage. The storage environment is defined as an environment where the air immediately surrounding the holographic disk has the following properties:

Temperature	16 °C to 32 °C
Atmospheric pressure	60 kPa to 106 kPa
Relative humidity	20 % to 80 %
Absolute air humidity	25g/m ³ max.
Air cleanliness	Office environment (see Annex J)

No condensation on the holographic disk shall occur.

8.1.3 Transportation

This Ecma Standard does not specify requirements for transportation. Guidance for transportation is given in Annex K.

8.2 Temperature shock

The holographic disk shall withstand a temperature shock of up to 10 °C when inserted into, or removed from, the drive.

8.3 Safety requirements

The disk shall satisfy the safety requirements of Standards ECMA-287 and ECMA-328, when used in the intended manner or in any foreseeable use in an information processing system.

8.4 Flammability

The disk and its components shall be made from materials that comply with the flammability class for HB materials, or better, as specified in Standard ECMA-287.

9 Reference Drive

The Reference Drive is a drive several critical components of which have well defined properties and which is used to test the read parameters of the disk for conformance to this Ecma Standard. This section gives an outline of all components; components critical for tests in specific sections are specified in those sections.

9.1 Optical system

The basic set-up of the optical system of the Reference Drive used for measuring the read parameters is shown in Figure 1a. Different components and locations of components are permitted, provided that the performance remains the same as that of the set-up in Figure 1a. The optical system shall be such that the detected light reflected from the entrance surface of the disk is minimized so as not to influence the accuracy of the measurements.

The combination of the polarizing beamsplitter PBS2 and quarter-wave plate separates the incident reading beam and the reading beam reflected from the holographic disk. The polarizing beamsplitter PBS2 shall have, at the reading beam wavelength λ_R , a p-s intensity transmittance ratio of at least 1000 and s-p intensity reflectance ratio of at least 80.

The dichroic beamsplitter DBS shall have a reflectance of at least 99 % for the tracking/addressing wavelength λ_T and a transmittance of at least 98 % for the reading wavelength λ_R .

The combination of the polarizing beamsplitter PBS1 and quarter-wave plate separates the incident tracking/addressing optical beam and the tracking/addressing beam reflected from the holographic disk. The polarizing beamsplitter PBS1 shall have, at the tracking/addressing beam wavelength λ_T , a p-s intensity reflectance ratio of at least 100.

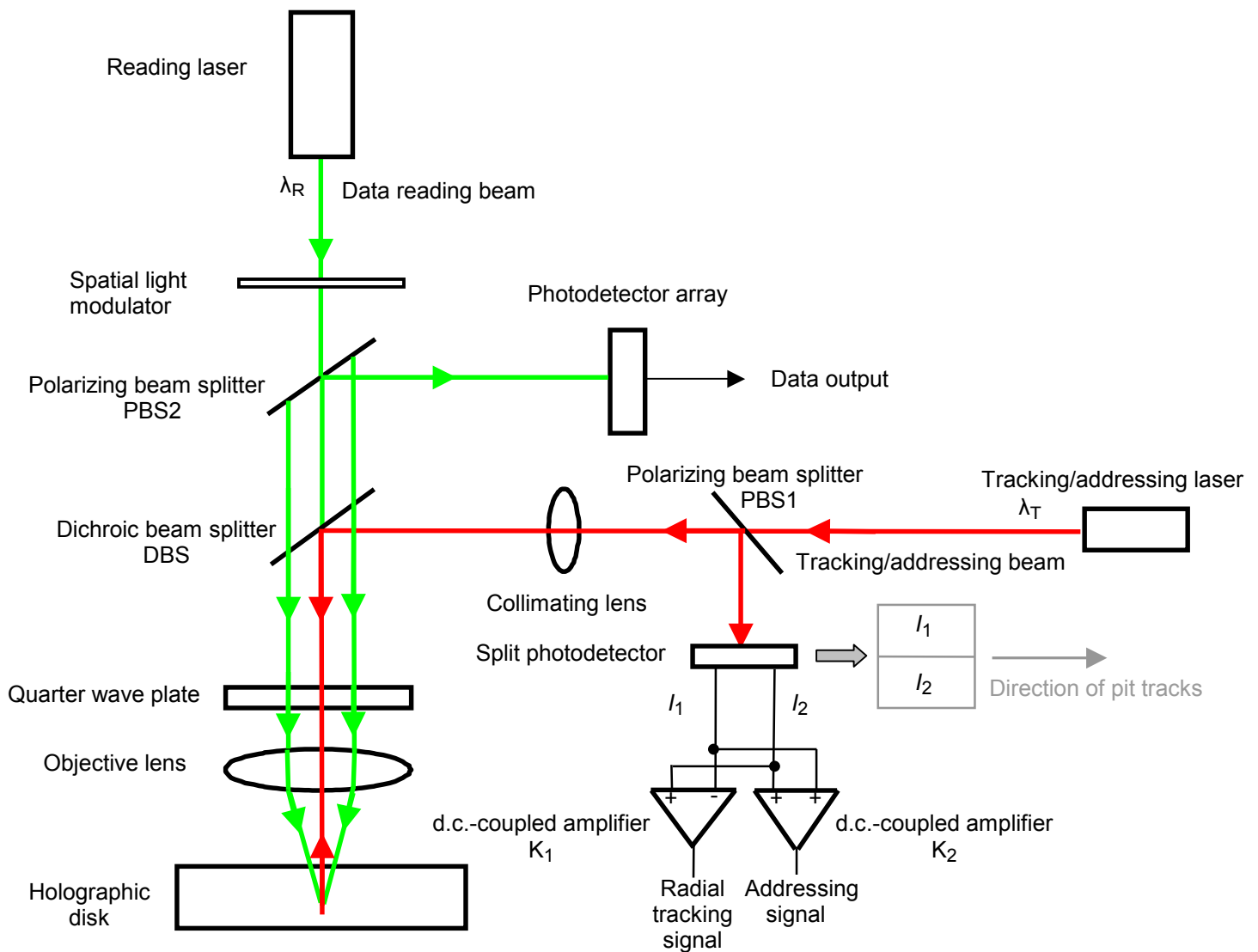

λ_T : Wavelength of the tracking/addressing beam
 λ_R : Wavelength of the data reading beam
 I_1, I_2 : Output currents from the split photodetector

Figure 1a – Optical system of the Reference Drive

9.2 Tracking and Addressing Channel

The Tracking and Addressing Channel shall be used to generate tracking/addressing information and read manufacture Specific Disk Information (SDI).

9.2.1 Tracking/addressing beam

The laser beam used for tracking/addressing shall have the following characteristics.

Wavelength	655 nm	+ 10 nm - 5 nm
Polarization	Circular	
Focal length of objective lens	Such that to conform to 9.4.2 specifications	
Numerical aperture	0,39 ± 0,01	
Light intensity at the rim of the pupil of the objective lens	≥ 40% of the maximum intensity level in the radial direction, and ≥ 40% in the tangential direction	
Wave front aberration from an ideal spherical wave front after passing through an ideal stack of disk layers	0,033 λ rms max.	
Relative Intensity noise (RIN)	-126 dB/Hz max.	

9.2.2 Tracking/Addressing/SDI signals

The method of generating the axial tracking error is not specified for the Reference Drive.

The radial tracking error signal shall be generated from the output currents of a split photodiode detector, the division of which runs parallel to the image of the pit tracks on the diode (see Figure 1a). The radial tracking error signal relates to the difference in the amount of light in the two halves of the exit pupil of the objective lens.

The amplifier K_1 after the photodetector shall be d.c.-coupled with the bandwidth characteristics specified in Clause 18.

The addressing information signal is generated from the reading signal issued from the sum of the output currents of the split photodiode detector. The addressing information reading signal relates to the total amount of light in the exit pupil of the objective lens. The amplifier K_2 after the photodetector shall be d.c.-coupled with the bandwidth characteristics specified in Clause 18.

The SDI signal shall be derived from the reading of the content of tracking data area of specific tracks, as specified in Clause 18.

9.3 Data Holographic Reading Channel

The Data Holographic Reading Channel shall be used to reconstitute the image from the stored hologram and read back the stored data.

9.3.1 Reading beam

The pulsed laser beam used for data reading shall have the following characteristics.

Wavelength	532 nm ± 0,1 nm	
Polarization	Circular	
Focal length of objective lens	5,000 mm ± 0,002 mm	
Numerical aperture	0,50 ± 0,01	
Light intensity at the rim of the pupil of the objective lens	≥ 55% of the maximum intensity level, in radial and tangential directions	

Wave front aberration from an ideal spherical wave front after passing through an ideal stack of disk layers	0,012 λ rms max.
Coherent length	$\geq 1,8$ mm
Laser pulse width	< 50 ns at half maximum
Laser pulse energy	as specified in SDI (see Annex D)

9.3.2 Reference Pattern

The reading beam shall be spatially modulated to generate the reading Reference Pattern light distribution shown on figure 1b.

The spatial light modulator (see Figure 1a) could be a physical passive transmissive or reflective element.

The content of the Reference Pattern in a plane perpendicular to the optical axis is specified versus a square pattern of 358x358 pixels with a pitch of $13,68 \mu\text{m} \pm 0,02 \mu\text{m}$ and a fill factor of $85,2\% \pm 0,1 \%$.

The Reference Pattern shall be constituted of 120 radial lines of On (illuminated) pixels. The size of the inner and outer diameters shall be 230 and 358 pixels. The width of the lines shall be 1 pixel.

The modulation ratio of the On/Off (illuminated/non-illuminated) pixels of the Reference Pattern shall be at least 500.

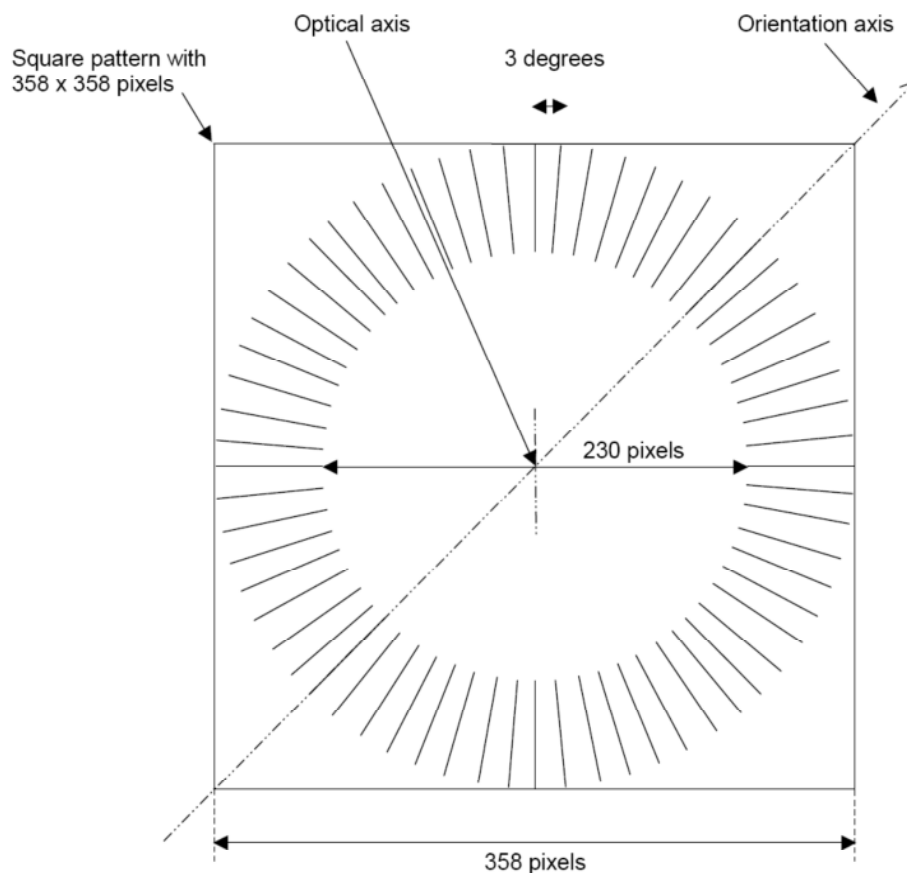
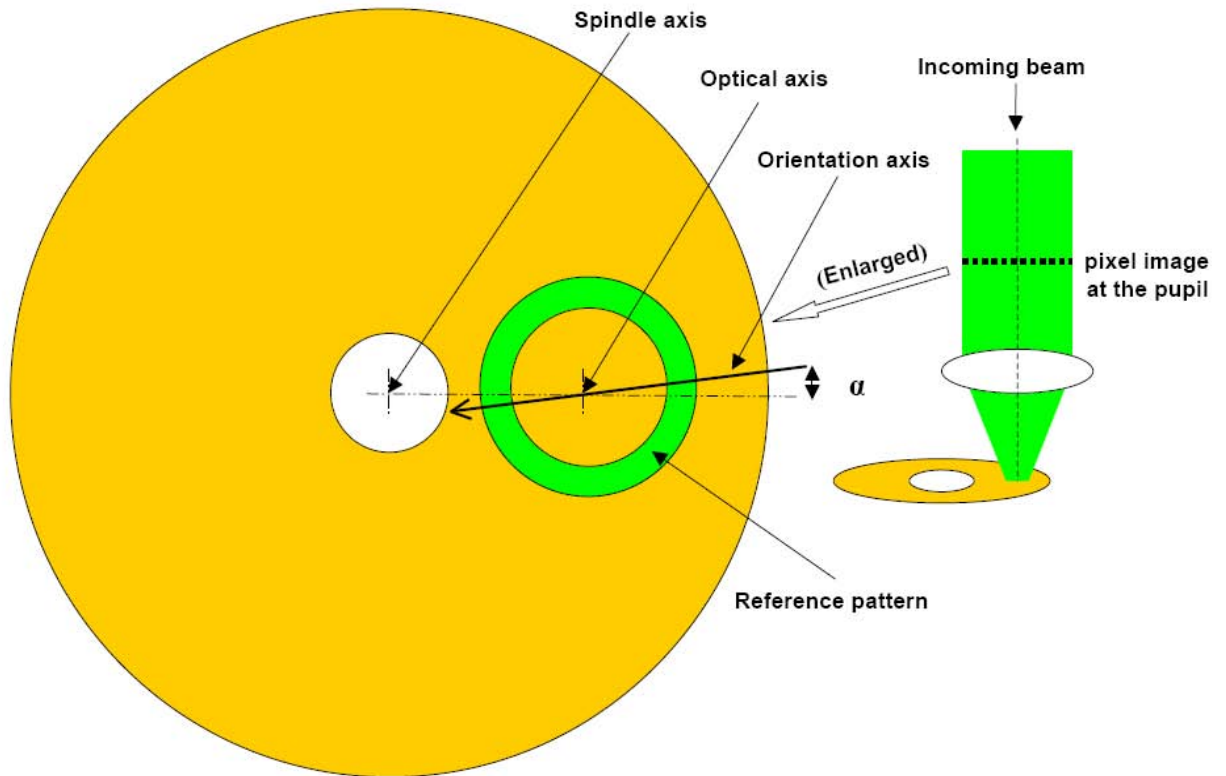

Figure 1b – Reference Pattern used to recover the stored image of the Data Page

The relative positioning of the Reference Pattern versus the spindle axis and the optical axis shall be as shown on Figure 1c.
 The orientation axis of the Reference Pattern shall be disposed in direction of the spindle axis with a tolerance α better than $\pm 0,01^\circ$.



*Figure 1c - Positioning of the Reference Pattern
 (Seen from the incoming beam side)*

9.3.3 Photodetector array

The photodetector array shall be constituted of 576x576 elements that shall be used for the detection of data stored in the Data Page.

The pitch of the elements shall be $12,0 \mu\text{m} \pm 0,5 \mu\text{m}$. The signal generated by each photodetector array element shall be linearly related to the energy received by this element during each reading pulse.

Data detection shall be performed as specified in Annex H.2.

9.4 Conditions for measuring the operational signals

9.4.1 Tracking, Addressing, Specific Disk Information

During the measurement of the signals, the focus of the tracking/addressing beam shall have an axial deviation of not more than

$$e_{\text{max}}(\text{axial}) = 0,23 \mu\text{m}$$

from the pit layer, and it shall have a radial deviation of not more than

$$e_{\text{max}}(\text{radial}) = 0,022 \mu\text{m}$$

from the centre of the track.

9.4.2 Data reading

During data reading, the relative positioning of the centres of the focus of the data reading beam and the tracking/addressing beam shall be such that their axial distance shall be $100 \mu\text{m} \pm 1 \mu\text{m}$, and their radial and tangential misalignments shall be less than $0,1 \mu\text{m}$.

9.4.3 Normalized servo transfer functions

9.4.3.1 Reference servo for axial tracking

The reference servo for axial tracking used for measurement of servo related parameters specifications shall be as specified in 10.5.6.

9.4.3.2 Reference servo for radial tracking

The reference servo for axial tracking used for measurement of servo related parameters specifications shall be as specified in 10.5.8.

9.4.4 Rotation of the disk

The spindle shall position the disk as specified in 11.1.

It shall rotate the disk at $300 \text{ rpm} \pm 30 \text{ rpm}$.

The direction of rotation of the disk shall be counter-clockwise when viewed from the objective lens.

Section 2 - Mechanical and physical characteristics

10 Dimensional, mechanical, and physical characteristics of the disk

10.1 General description of the disk

The disk shall consist of a circular substrate with a hole in the centre, bearing a stack of layers incorporating the holographic storage layer (see Figure 2). The storage layer is protected from environmental influences by a laser-transparent protective cover layer.

The centring of the disk on the drive spindle is performed on the edge of the centre hole of the substrate. Clamping is performed in the Clamping Zone (see Figure 3).

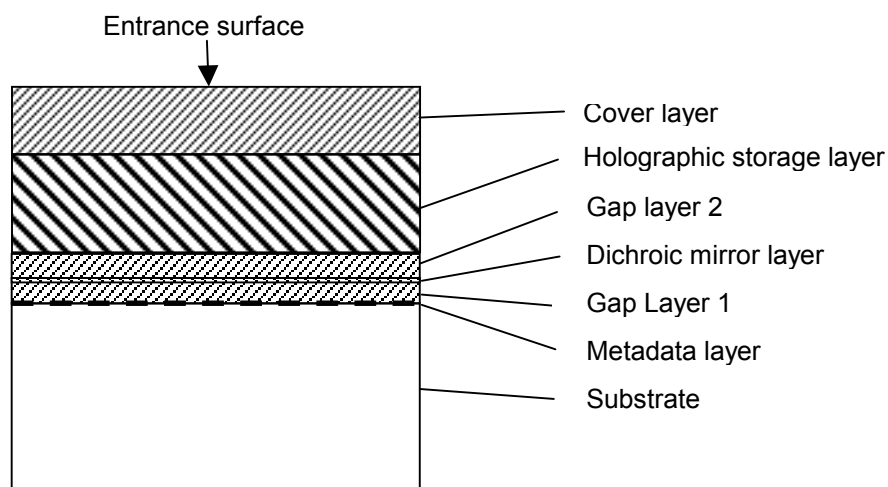

Figure 2 – Layers structure of the disk

10.2 Reference axis and plane of the disk

Some dimensions of the disk are referred to a Disk Reference Plane D (see Figure 3). Plane D is defined by the perfectly flat annular surface of an ideal spindle onto which the Clamping Zone of the disk, on the entrance surface, is clamped, and which is normal to the axis of rotation of this spindle. The Reference Axis A of the disk passes through the centre of the centre hole of the disk, and is normal to Disk Reference Plane D.

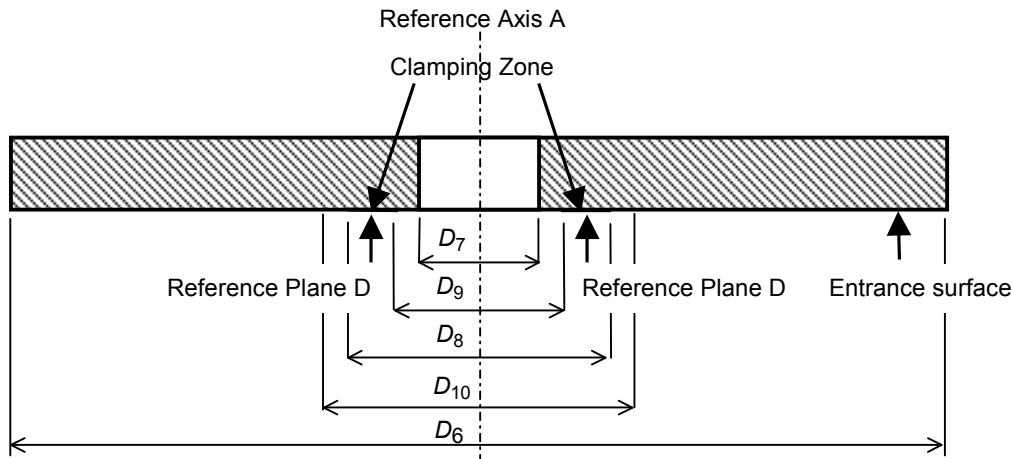

Figure 3 – Disk dimensions

10.3 Dimensions of the disk

The dimensions of the disk shall be measured in the operating environment. The outer diameter of the disk shall be (see Figure 3)

$$D_6 = 120 \text{ mm} \pm 0,30 \text{ mm}$$

The centre hole shall have a diameter

$$D_7 = 15,00 \text{ mm} \begin{matrix} + 0,15 \text{ mm} \\ - 0,00 \text{ mm} \end{matrix}$$

There shall be no burr on the edges of the centre hole.

The edge of the centre hole shall be rounded off or chamfered. The rounding radius shall be 0,1 mm max. The chamfer shall extend over a height of 0,1 mm max.

The total thickness of the disk shall be 2,3 mm min. and 2,6 mm max.

10.4 Clamping Zone

The Clamping Zone is the area on the entrance surface of the disk where the clamping mechanism of the drive grips the disk and is defined by D_8 and D_9 (see Figure 3).

The clearance zone extending from the outer diameter of the Clamping Zone (D_8) to the inner diameter of the reflective zone (D_{10}) shall be excluded from the total thickness requirement; however there shall be no projection from the Disk Reference Plane D in the direction of the optical system of more than 0,2 mm in this zone.

The outer diameter of the Clamping Zone shall be

$$D_8 = 28 \text{ mm min.}$$

The inner diameter of the Clamping zone shall be

$$D_9 = 22 \text{ mm max.}$$

10.5 Mechanical characteristics

All requirements in this clause shall be met in the operating environment.

10.5.1 Material

The disk shall be made from any suitable materials such that it meets the requirements of this Ecma Standard.

10.5.2 Mass

The mass of the disk shall not exceed 80 g.

10.5.3 Moment of inertia

The moment of inertia of the disk relative to axis A shall not exceed 0,160 g·m².

10.5.4 Imbalance

The imbalance of the disk relative to axis A shall not exceed 0,040 g·m.

10.5.5 Axial deflection

The axial deflection of the disk is measured as the axial deviation of the tracking/addressing pit layer. Thus it comprises the tolerances on the thicknesses of the crossed layers, on their indexes of refraction, and the deviation of the entrance surface from the Disk Reference Plane D.

The deviation of any point of the tracking/addressing pit layer from its nominal position, in a direction normal to the Disk Reference Plane D, shall not exceed 0,3 mm in the Formatted Zone for rotational frequencies of the disk as specified in 9.4.4. The deviation shall be measured by the optical system defined in 9.1.

10.5.6 Axial acceleration

The maximum allowed axial error e_{\max} (see Annex L) shall not exceed 0,23 μm, measured using the Reference Servo for axial tracking of the tracking/addressing layer. The rotational frequency of the disk shall be as specified in 9.4.4. The stationary part of the motor is assumed to be motionless (no external disturbances). The measurement shall be made using a servo with the transfer function

$$H_s(i\omega) = \frac{1}{3} \times \left(\frac{\omega_0}{i\omega} \right)^2 \times \frac{1 + \frac{3i\omega}{\omega_0}}{1 + \frac{i\omega}{3\omega_0}}$$

where $\omega = 2\pi f$, $\omega_0/2\pi = 450$ Hz, $i = \sqrt{-1}$

or any other servo with $|1 + H|$ within the 20 % of $|1 + H_s|$ in the bandwidth of 5 Hz to 1 kHz. Thus, the disk shall not require an acceleration of more than 0,38 m/s² at low frequencies from the servo motor of the Reference Servo.

10.5.7 Radial runout

The radial runout of the tracks in the tracking/addressing pit layer is measured as seen by the optical head of the Reference Drive. Thus it includes the distance between the axis of rotation of the spindle and reference axis A, the tolerances on the dimensions between axis A and the location of the track, and effects of non-uniformities in the index of refraction of the stack of layers.

The radial runout is the difference between the maximum and the minimum distance of any track from the axis of rotation, measured along a fixed radial line over one track. The radial runout shall not exceed 70 μm as measured by the optical system under conditions of a disk mounted on a perfect sized test fixture shaft, for rotational frequencies of the disk as specified in 9.4.4.

10.5.8 Radial acceleration

The maximum allowed radial error e_{\max} (see Annex L) shall not exceed 0,022 μm, measured using the Reference Servo for radial tracking of the tracks. The rotational frequency of the disk shall be as specified in 9.4.4. The stationary part of the motor is assumed to be motionless (no external disturbances).

The measurement shall be made using a servo with the transfer function

$$H_s(i\omega) = \frac{1}{3} \times \left(\frac{\omega_0}{i\omega} \right)^2 \times \frac{1 + \frac{3i\omega}{\omega_0}}{1 + \frac{i\omega}{3\omega_0}}$$

where $\omega = 2\pi f$, $\omega_0/2\pi = 650$ Hz, $i = \sqrt{-1}$

or any other servo with $|1 + H|$ within the 20 % of $|1 + H_s|$ in the bandwidth of 5 Hz to 1,0 kHz. Thus, the disk shall not require an acceleration of more than 0,08 m/s² at low frequencies from the servo motor of the Reference Servo.

10.5.9 Tilt

The tilt angle, defined as the angle that the normal to the entrance surface, averaged over a circular area of 1 mm diameter, makes with the normal to the Disk Reference Plane D, shall not exceed 0,80° in the radial direction and 0,30° in the tangential direction, in the Formatted Zone.

10.6 Optical characteristics

10.6.1 Substrate

The substrate has no optical requirement.

10.6.2 Metadata layer

The Metadata layer shall be constituted of a reflective layer bearing data pits.

10.6.3 Gap layer 1

The thickness and index of refraction of Gap layer 1 at wavelength λ_T shall be such that within the Formatted Zone, the combined stack of layers specifications of 10.6.8 and 10.6.9 shall be met.

10.6.4 Dichroic mirror layer

The reflectance of the dichroic mirror layer within the Formatted Zone, measured according to Annex A, shall be at least 80% at wavelength λ_R specified in 9.3.1.

10.6.5 Gap layer 2

The thickness, index of refraction and birefringence of Gap layer 2 at wavelengths λ_T and λ_R shall be such that within the Formatted Zone, the combined stack of layers specifications of 10.6.8 and 10.6.9 shall be met.

10.6.6 Holographic storage layer

The holographic storage layer shall be used to store the Data Page holograms.

Its thickness, and index of refraction and birefringence shall be such that within the Formatted Zone, the combined stack of layers specifications of 10.6.8 and 10.6.9 shall be met.

10.6.7 Cover layer

The cover layer shall be used to protect the other layers.

Its thickness and index of refraction shall be such that within the Formatted Zone, the combined stack of layers specifications of 10.6.8 and 10.6.9 shall be met.

10.6.8 Thicknesses of the stack of layers

The thickness within the Formatted Zone of the stack "cover layer + holographic storage layer + Gap layer 2 + Dichroic mirror layer + Gap layer 1" shall be determined versus the average index of refraction N_{AV} at wavelength λ_T , as specified in Figure 4.

The thickness within the Formatted Zone of the stack "cover layer + holographic storage layer + Gap layer 2" shall be determined versus the average index of refraction N_{AV} at wavelength λ_R , as specified in Figure 5.

The average index N_{av} of the stack of layers with individual thicknesses and indexes T_i and N_i shall be calculated as $N_{av} = \frac{\sum N_i \cdot T_i}{\sum T_i}$, with $1,45 \leq N_i \leq 1,65$.

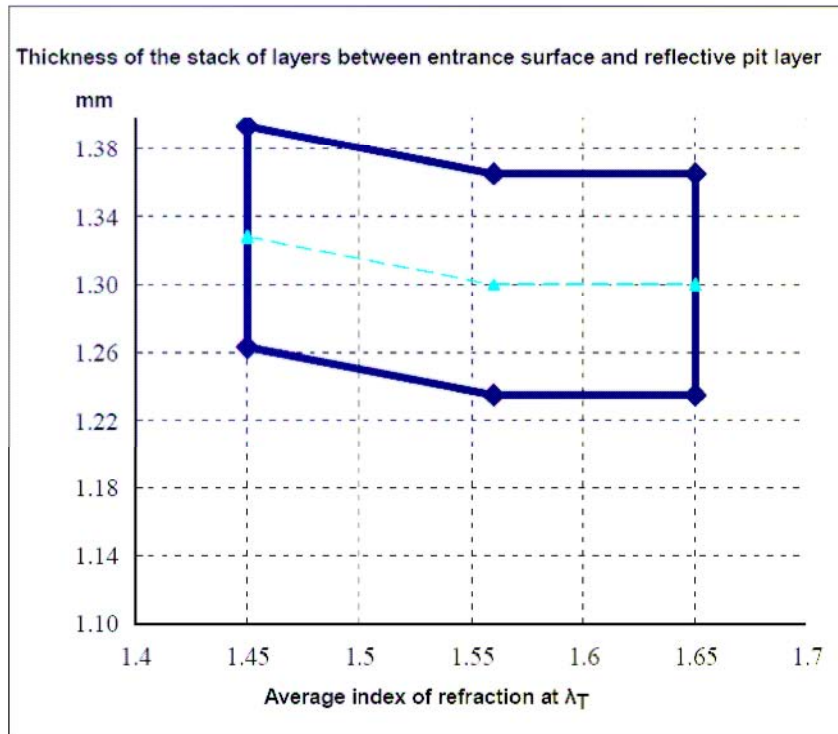

Figure 4 – Thickness of stack of layer between entrance surface and reflective pit Layer

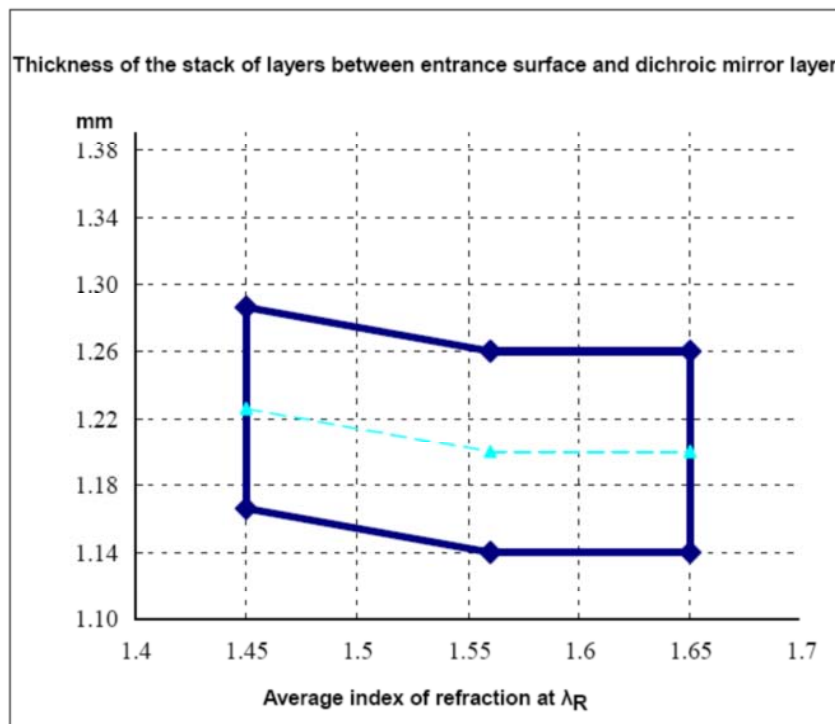

Figure 5 – Thickness of stack of layers between entrance surface and dichroic mirror layer

10.6.9 Birefringence of the stack of layers

The birefringence of the layers within the Formatted Zone, measured according to Annex B, shall be less than:

- 100 nm for the stack "cover layer + holographic storage layer + Gap layer 2 + Dichroic mirror layer + Gap layer 1" at wavelength λ_T ,
- 100 nm for the stack "cover layer + holographic storage layer + Gap layer 2" at wavelength λ_R .

11 Interface between disk and drive

11.1 Clamping method

The drive spindle engages the disk by its centre hole. The disk is held against the spindle by an axial clamping force. The radial positioning of the disk is provided by the centring of the axis of the spindle in the centre hole of the disk. A turntable of the spindle shall support the disk in its Clamping Zone, determining the axial position of the disk in the case.

11.2 Tapered cone for disk clamping

The device used for centring the disk for test measurements shall be a cone as defined in Annex C.

11.3 Clamping force

The clamping force exerted by the spindle shall be less than $2,0 \text{ N} \pm 0,2 \text{ N}$.

Section 3 - Format of information

12 General description

This section specifies:

- the format of the tracking/addressing information and manufacture specific disk information contained in the pit layer,
- the format of the data information stored in form of holograms in the storage layer.

13 Tracking and addressing information format / Specific Disk Information format

The tracking and addressing information and manufacture Specific Disk Information shall be disposed along circular concentric tracks on the internal surface of the substrate and shall consist of successive depressions as seen from the entrance surface of the disk, called pits, in the otherwise flat reflective layer. The information shall be represented by variations of pit length and distance between pits.

There shall be 20 172 pit tracks.

The first pit track at the inside of the disk shall be located at radius $22,4 \text{ mm}$
 $+ 0,2 \text{ mm}$
 $- 0,0 \text{ mm}$

13.1 Pit track pitch

The pit track pitch shall be $1,6 \mu\text{m} \pm 0,1 \mu\text{m}$.

The pit track pitch averaged over the Formatted Zone shall be $1,6 \mu\text{m} \pm 0,01 \mu\text{m}$.

13.2 Pit track format

The pit track format is described hereafter in term of Channel bits.

Each track shall contain 302 400 Channel bits. At the nominal test rotation speed of 300 rpm the nominal channel bit time period T shall be 661ns.

The physical Channel bit length shall consequently vary with the track radius.

13.2.1 Sector

The track (one revolution) shall be divided in 120 Sectors numbered from 0 to 119.

The Sector layout shall be as shown in Figure 6.

Header	Sync	Tracking data	Land
Number of Channel bits per field			
184	40	2288	8
Sector total Channel bits = 2520			

Figure 6 – Sector format

13.2.2 Header

The header layout shall be as shown in Figure 7.

Address Mark	Address data	ECC	Reserved field
Number of Channel bits per field			
48	64	32	40
Header total Channel bits = 184			

Figure 7 – Header format

13.2.2.1 Address Mark

The Address Mark shall consist of a pattern that does not occur elsewhere in the Sector. It shall have length of 48 Channel bits with the following pattern:

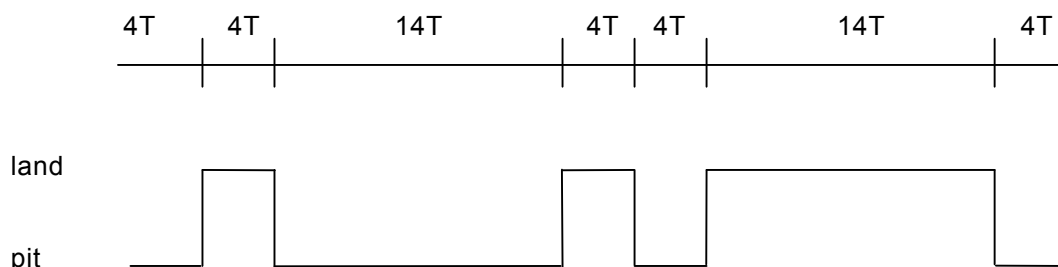

Total: 48 Channel bits

Figure 8 – Address Mark

13.2.2.2 Address data

The Address data format shall be as shown in Figure 9.

Control data	Track number H	Track number L	Sector number
Number of Channel bits per field			
16	16	16	16
Address total Channel bits = 64			

Figure 9 – Address data

The Control data bits shall be generated as shown in Figure 9.a.

The track address of the first track at inner radius shall be –1 280.

The track addresses of tracks located at radii larger than Track –1 280 shall be increased by 1 for each track.

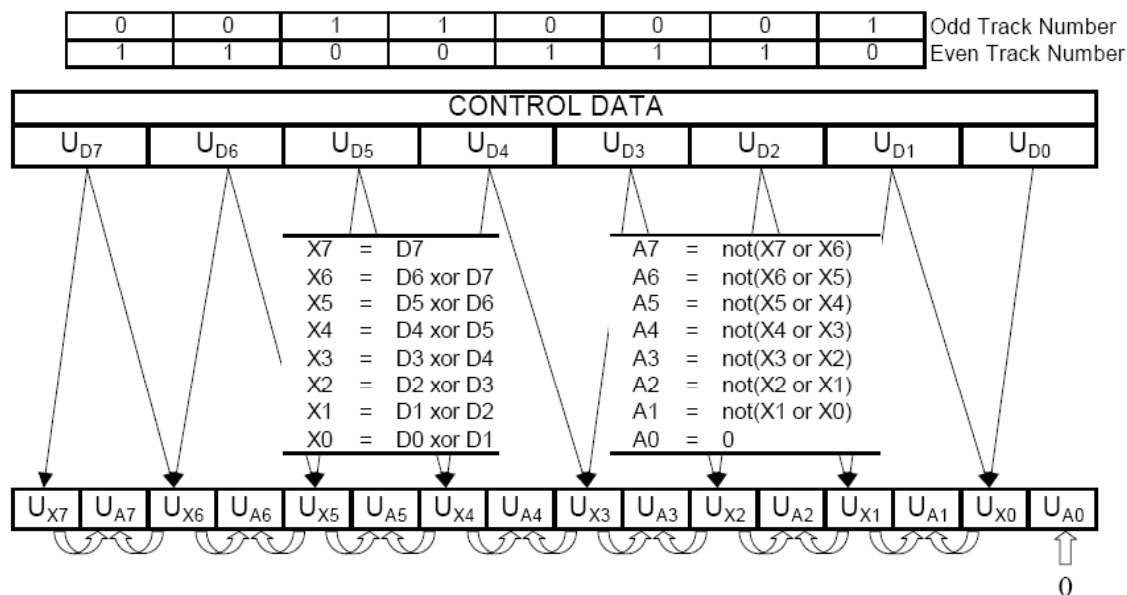

Figure 9.a – Generation of Control data

The higher 16 bits, Track Number H, of Track Number data bits shall be generated as shown in Figure 9.b.

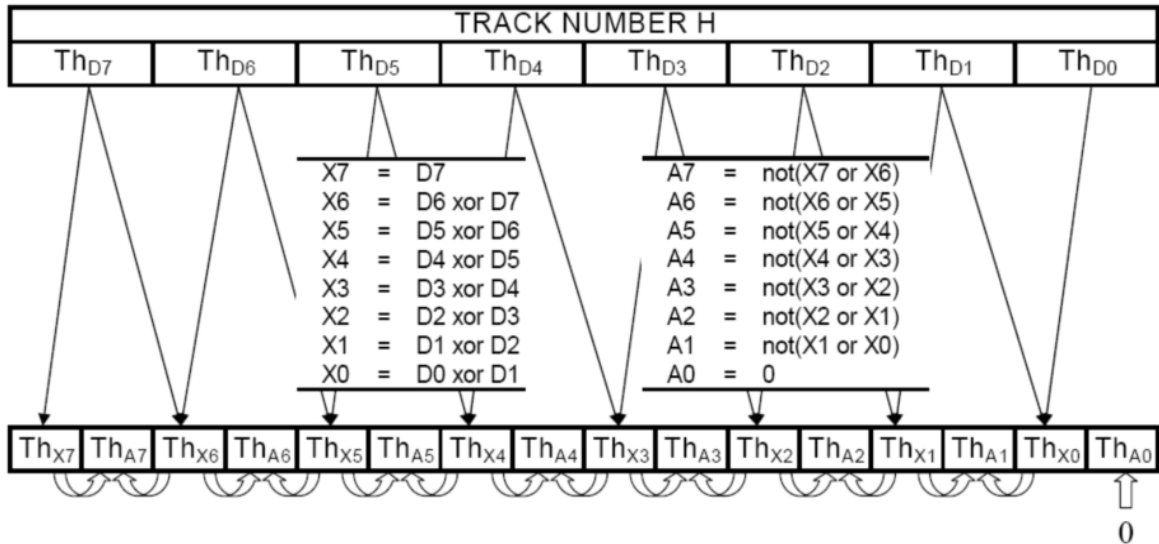

Figure 9.b – Generation of higher digits of Track Number data

The lower 16 bits, Track Number L, of Track Number data bits shall be generated as shown in Figure 9.c.

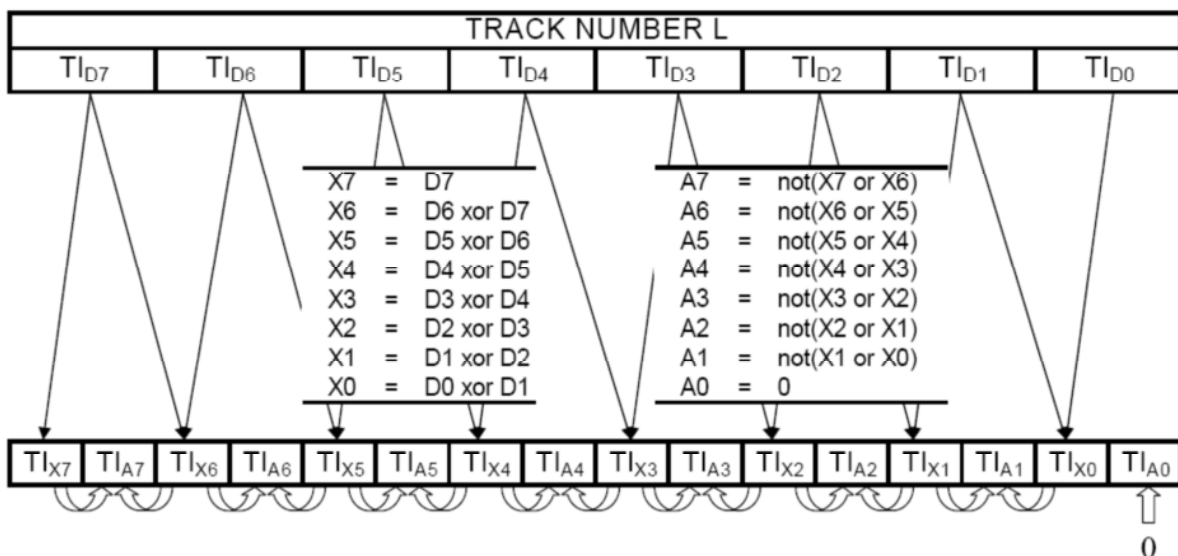

Figure 9.c – Generation of lower digits of Track Number data

The Sector Number data bits shall be generated as shown in Figure 9.d.

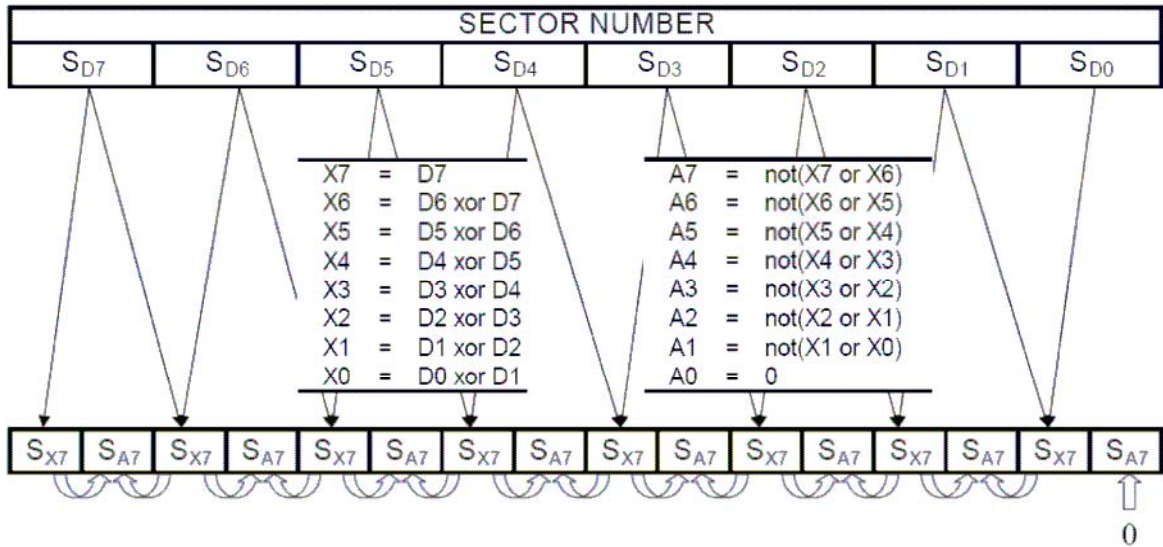

Figure 9.d – Generation of Sector Number data

13.2.2.3 ECC

The ECC data format shall be as shown in Figure 10.

Control data ECC	Track number H ECC	Track number L ECC	Sector number ECC
8	8	8	8
Number of Channel bits per field			
ECC total Channel bits = 32			

Figure 10 – ECC data

The higher digits of ECC data bits shall be generated as shown in Figure 10.a.

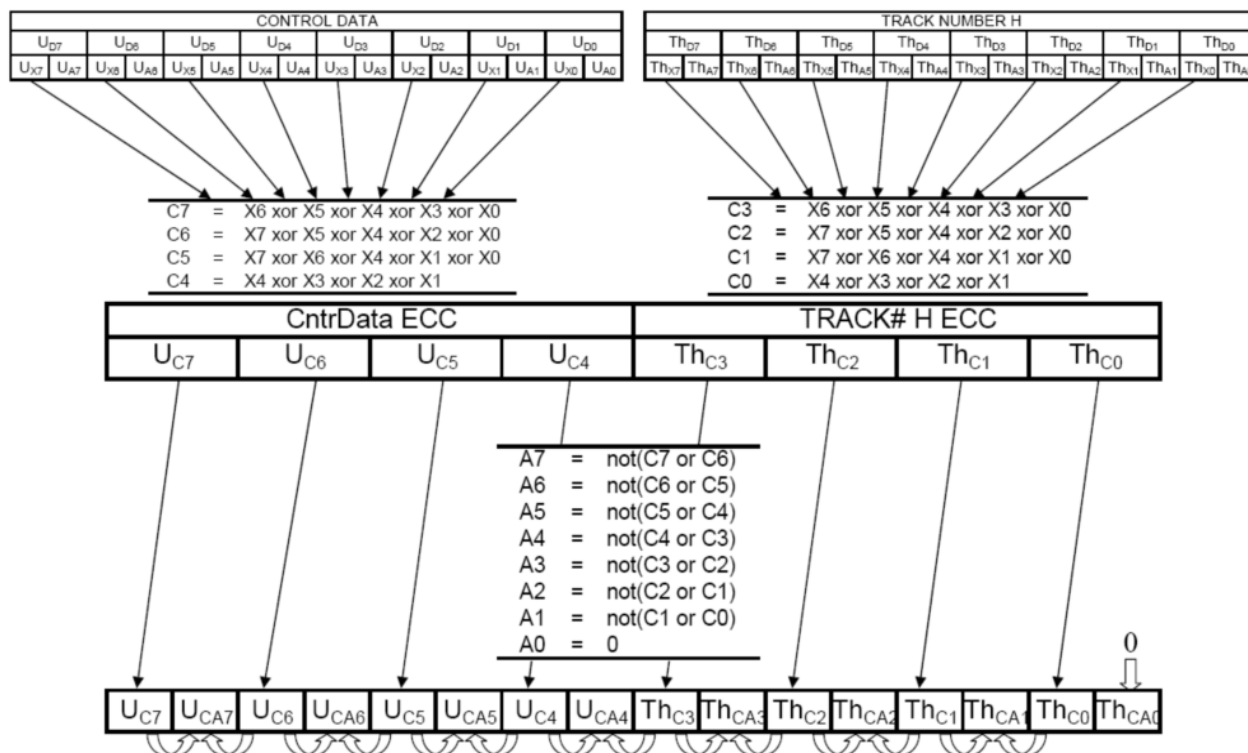

Figure 10.a – Generation of higher digits of ECC data

The lower digits of ECC data bits shall be generated as shown in Figure 10.b.

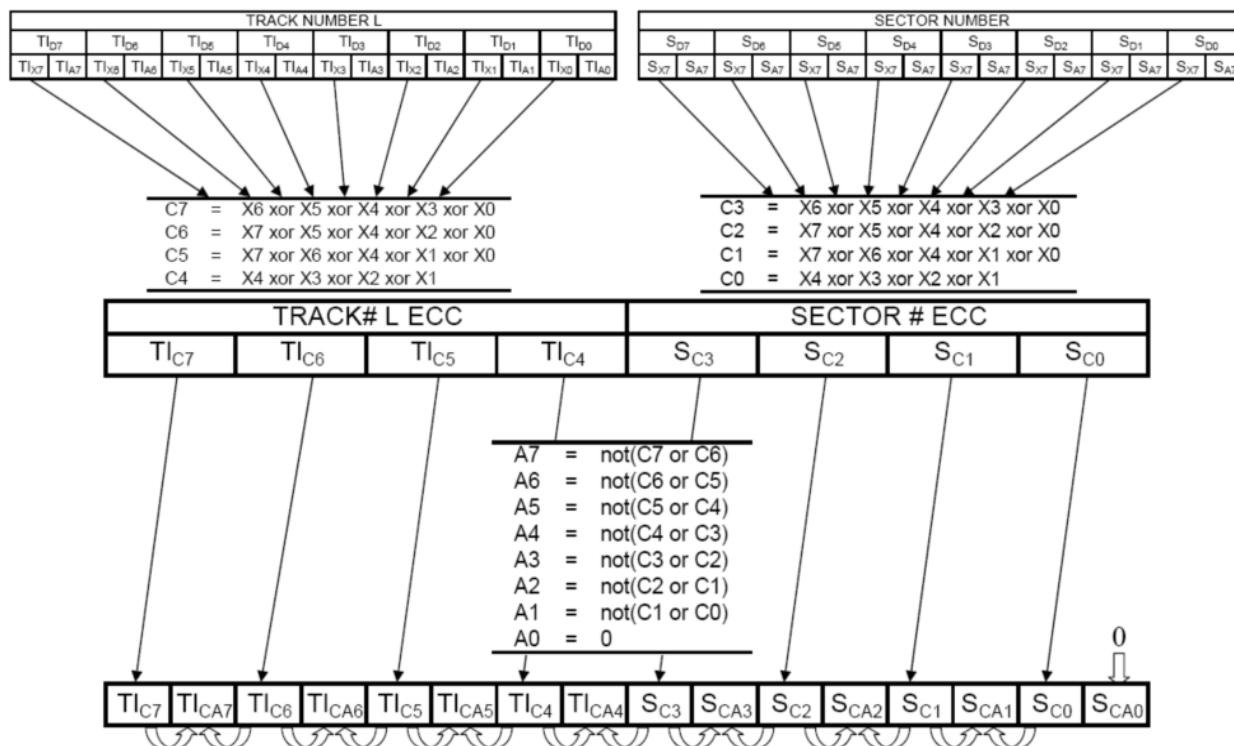

Figure 10.b – Generation of lower digits of ECC data

13.2.2.4 Reserved field

The reserved field shall be a blank space of 40 Channel bits length.

The reserved field shall be ignored in interchange.

13.2.3 Sync

This field shall have a 40 channel bits length and shall consist of a 3T/16T/16T/5T land/pit pattern, as shown on Figure 11.

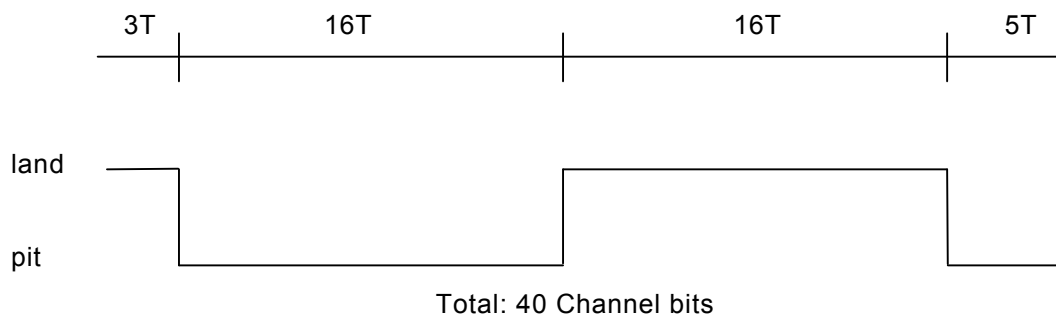

Figure 11 – Sync field pattern

13.2.4 Tracking data

This field shall have a 2288 channel bits length and shall consist of a 4T land / 4T pit pattern, starting with a 4T land as shown on Figure 12.

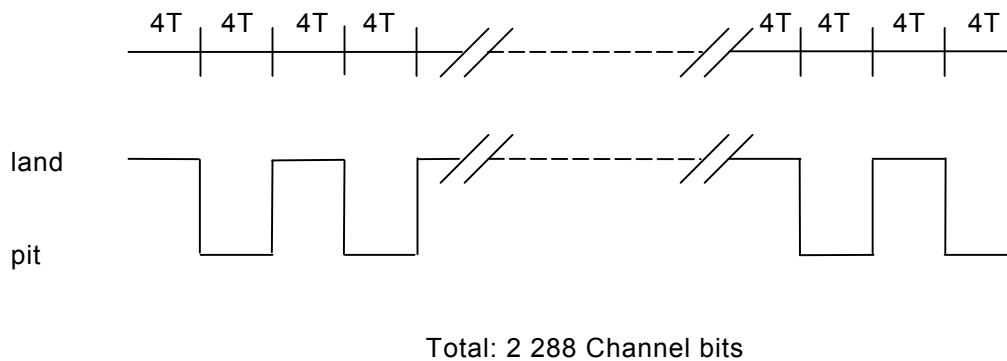

Figure 12 – Tracking data pattern

13.2.5 Land

Each Sector shall finish with a land field with a length of 8 Channel bits.

13.3 Specific Disk Information (SDI)

The Specific Disk Information (SDI) shall be stored in the tracking data area of the Lead-in tracks of the pit layer, as specified in Annex D.

13.3.1 SDI bytes encoding

The encoding of the SDI bytes shall be processed as shown on Figure 13.

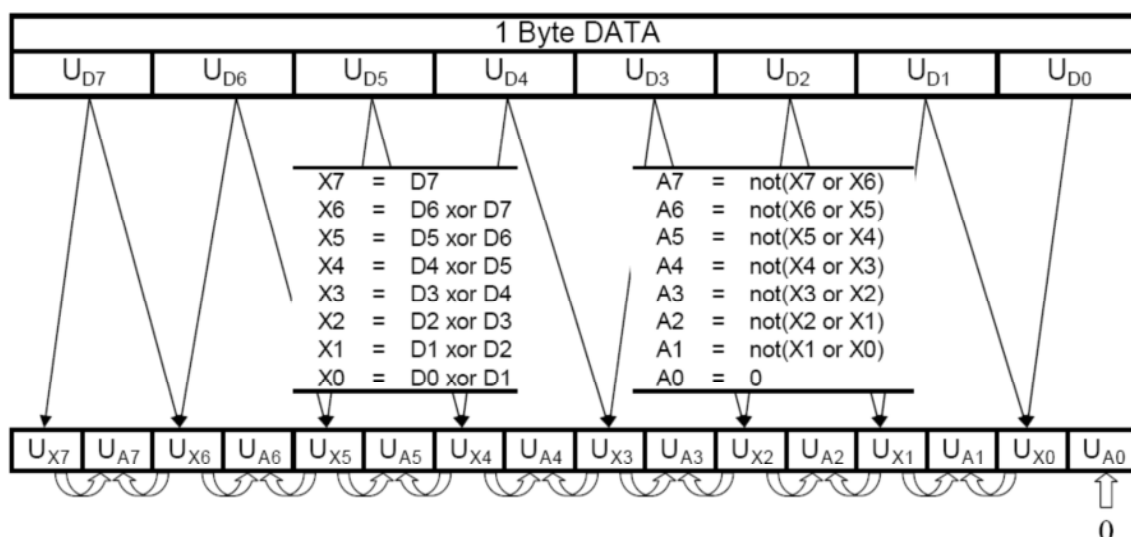

Figure 13 – SDI bytes encoding

13.4 Radial alignment

The misalignment δ of the Channel bits of adjacent tracks (see Figure 14) shall be less than ± 50 nm.



Figure 14 – Channel bit alignment

14 Data information format

The data information shall be stored in the form of holograms in the volume of the storage layer. Each hologram shall contain a Data Page of information.

14.1 Data Page holograms layout in the storage layer

All hologram layout format characteristics shall be specified in reference to the pit layer, as access to the information in the holographic storage layer is defined through the tracking/addressing features of the pit layer. The hologram track address shall be in particular designated by the corresponding pit track address.

14.1.1 Radial Data Page hologram pitch

The radial Data Page hologram pitch, the hologram track pitch, shall correspond to 8 pit track pitches.

14.1.2 Data Page hologram layout within tracks

A track in the storage layer (one revolution of the disk) shall contain 840 Peapods (see Figure 15), each comprising a number of n holograms depending on the Zone, as specified in Clause 14.1.3.

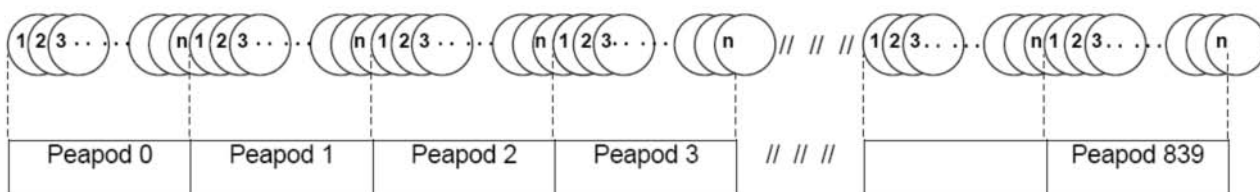

Figure 15 – Peapods layout

14.1.3 Zones / Tangential Data Page hologram pitch / Number of Data Page holograms per Peapod

The holograms shall be exclusively stored in the tracking data area of the track. Within this area the tangential Data Page hologram pitch shall be the same in Zones defined in Table 1. This pitch shall vary from 8 to 4 Channel bit periods depending on the Zone.

The centre of holograms shall coincide with passages to Zero of the Channel bit period signal. The centre of the first hologram in a track shall coincide with the third transition of the pit signal in the tracking data area (see Figure 16).

The holograms shall be stored in sequential order so that to fill successively all positions 1 of the Peapods and then successively all positions 2 of the Peapods and then all position 3, ... etc. until all available positions in all Peapods have been used (see Figure 15).

The number of holograms stored in the last (7th) Peapod of each Sector (see Table 1) shall be reduced due to the smaller tracking data area space available for this Peapod at the end of each Sector.

Table 1 – Zones with different tangential Data Page hologram pitches

Zone	Start pit track number	End pit track number	Number of pit tracks	Start address	End address	Number of hologram tracks	Tangential hologram pitch (Number of Channel bit periods)	Holograms per Peapod	
								Peapods* 0,1, ... 5 7, 8, ...12 833, 834, ... 838	Peapods** 6, 13, 839
0	- 1 280	- 1	1 280	(FB00)	(FFFF)	0	--	--	--
1	0	1 279	1 280	(0000)	(04FF)	160	8	45	15
2	1 280	2 559	1 280	(0500)	(09FF)	160	8	45	15
3	2 560	3 839	1 280	(0A00)	(0EFF)	160	8	45	15
4	3 840	5 119	1 280	(0F00)	(13FF)	160	8	45	15
5	5 120	6 399	1 280	(1400)	(18FF)	160	8	45	15
6	6 400	7 679	1 280	(1900)	(1DFF)	160	8	45	15
7	7 680	8 959	1 280	(1E00)	(22FF)	160	8	4T	15
8	8 960	10 239	1 280	(2300)	(27FF)	160	8	45	15
9	10 240	11 519	1 280	(2800)	(2CFF)	160	8	45	15
10	11 520	12 799	1 280	(2D00)	(31FF)	160	8	45	15
11	12 800	14 079	1 280	(3200)	(36FF)	160	8	45	15
12	14 080	15 359	1 280	(3700)	(3BFF)	160	8	45	15
13	15 360	16 639	1 280	(3C00)	(40FF)	160	4	90	30
14	16 640	17 919	1 280	(4100)	(45FF)	160	4	90	30
15	17 920	18 879	960	(4600)	(49BF)	120	4	90	30
16	18 880	18 891	12	(49C0)	(49CB)	2	4	90	30

NOTES: * First six Peapods of Sectors.

** Last seventh Peapods of Sectors.

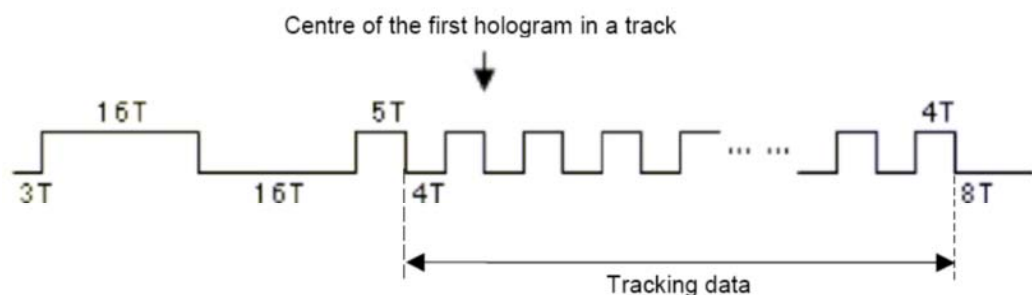

Figure 16 – Position of the first Data Page hologram in a track

14.2 Data Page encoding

14.2.1 User data

The user data bytes shall be processed as shown on Figure 17 to generate the content of the Data Page of the hologram.

Each 192 512 user data bytes shift shall be formatted in 188 packets of 1 024 bytes (see figure 18).

15.2.4.2 Page number

4 bytes sequential Page numbers shall be added to each of the preceding (188+20) packets. Page number 0 shall be given to the first Page at inner diameter. Page numbers shall be incremented by one for each following Page.

14.2.4.3 Intra-Page ECC

The 1 072 bytes of each of the here above 208 packets shall be processed as specified in Annex E2 to generate 560 Intra-Page ECC bytes that shall be added to each of these 1 072 bytes to constitute the 1 632-bytes content of the Data Page, as shown on Figure 19.

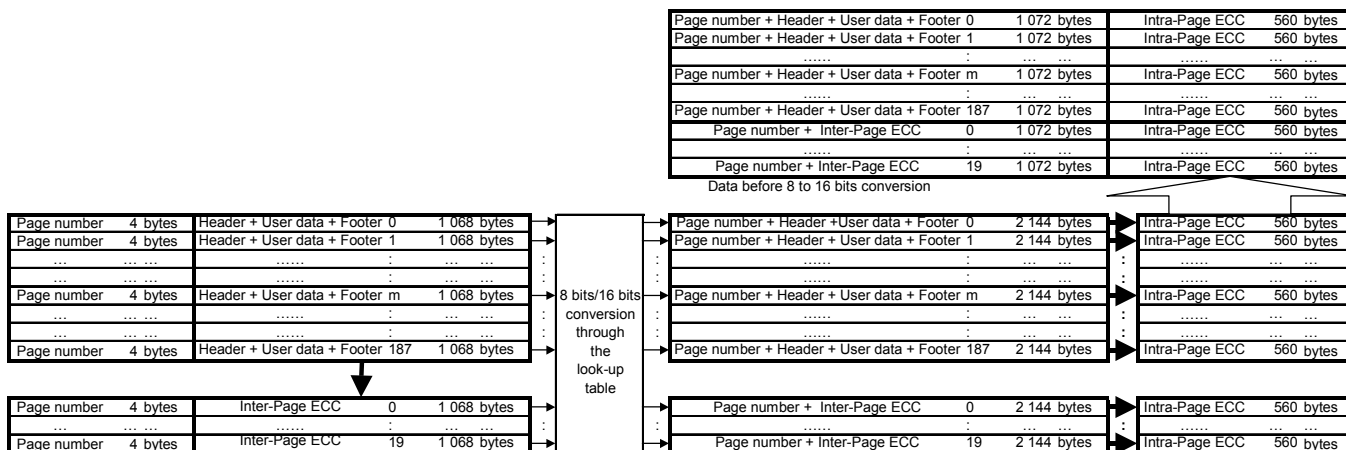

Figure 19 – Inter-Page and Intra-Page ECC codes

14.2.5 Scrambling

The 1 632-bytes Data Page content shall be scrambled by means of the circuit shown in Figure 20 which shall consist of a feedback bit shift register in which bits r_7 (msb) to r_0 (lsb) represent a scrambling byte at each 8-bit shift. The scrambling shall start at the beginning of each every 208 Pages, with pre-set values of positions r_{14} to r_0 of the shift register as specified in figure 20.

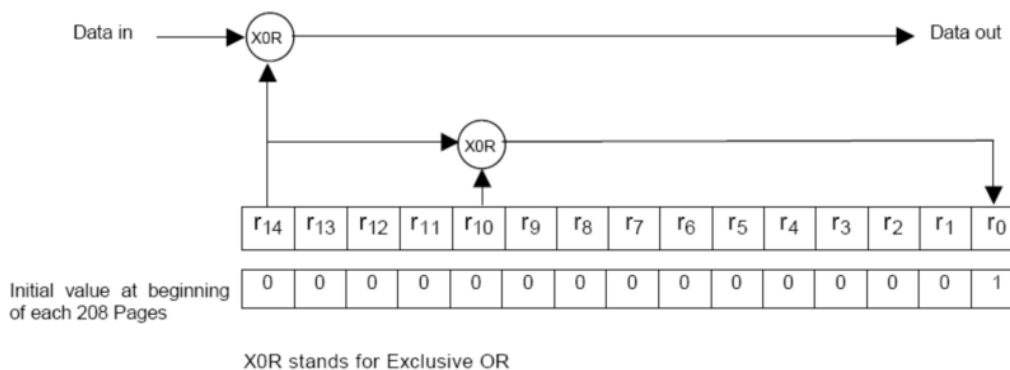

Figure 20 – Feedback shift register for generating the scrambling bytes

14.3 Digital to image conversion

14.3.1. 8 bits to 16 bits conversion

Each of the 1 632 bytes corresponding to the content of a page shall be transformed to 2x1 632 bytes by a 8 to 16 bits conversion using the look-up table shown on figure 21.

This conversion shall be such that three 1's shall appear within each successive 16 bits.

Each 1 632 obtained bytes shall represent the hologram content of a Data Page (see Figure 22).

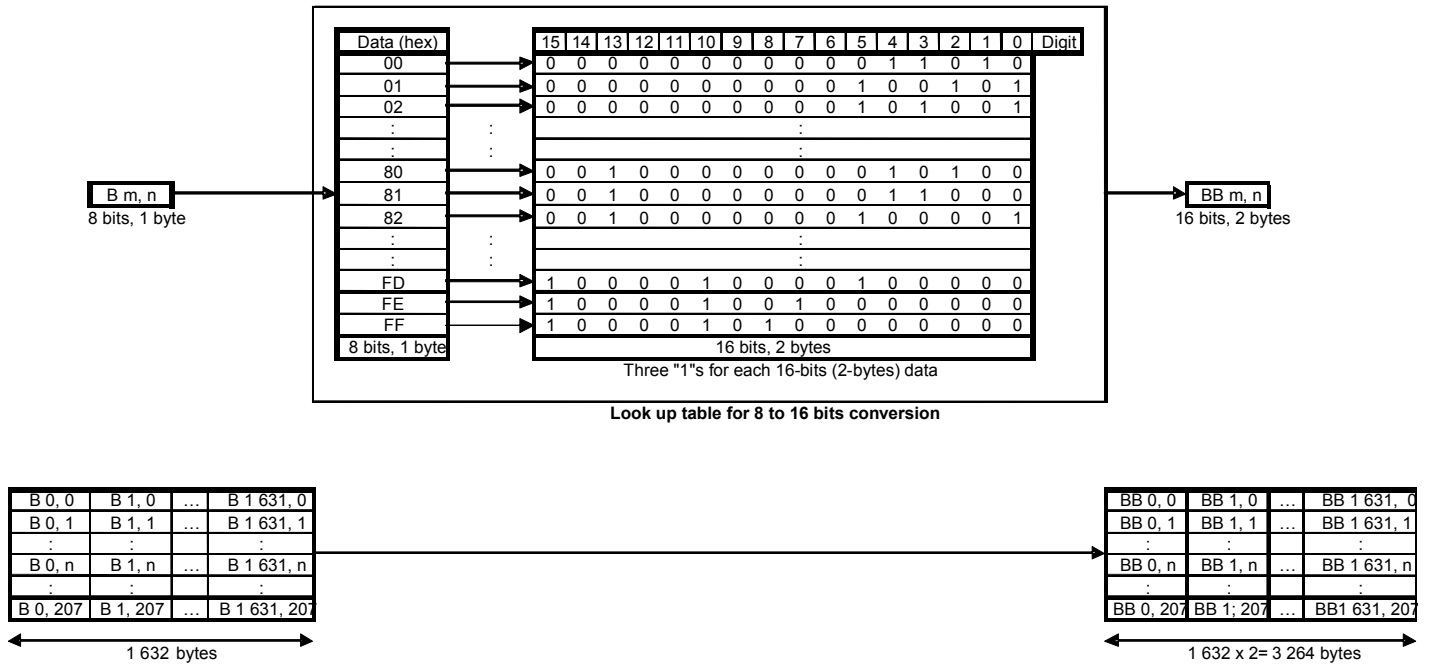

Figure 21 – 8 to 16 bits conversion

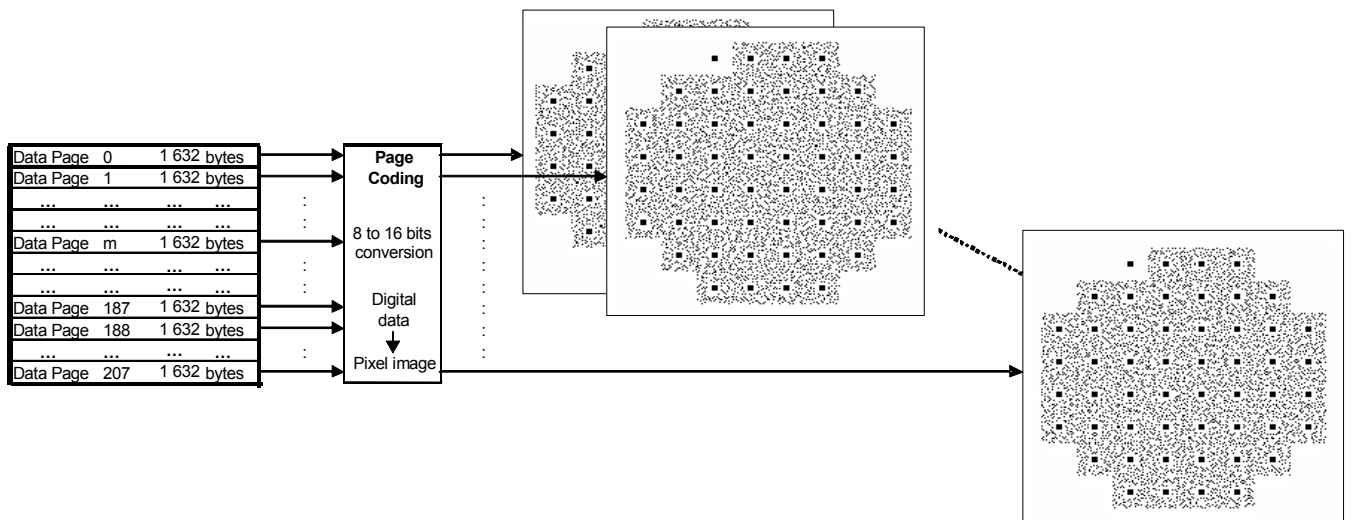

Figure 22 – Data Page image generation

14.3.2 Symbol/Sub-Page

After the 8 to 16 bits conversion, each 16 bits shall be represented in the Data Page by a 4X4 On/Off-pixels Symbol, as illustrated on Figure 23, using the look-up table of Annex F.

Bits to One shall correspond to On (illuminated)-pixels of the Data Page.
 Bits to Zero shall correspond to Off (non-illuminated)-pixels of the Data Page.

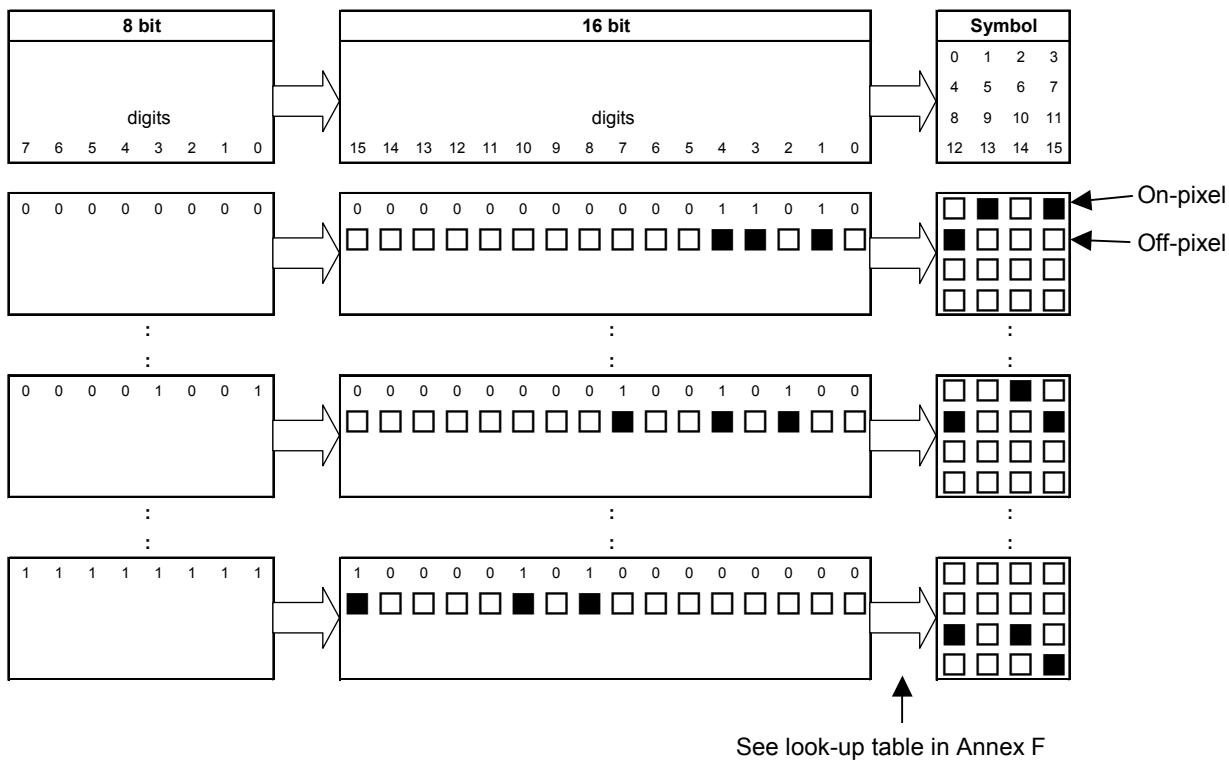

Figure 23 – Data Page pixel symbols representation after 8 to 16 bits conversion

A Sub-Page Sync Mark constituted of 16 On-pixels shall be added to 32 Symbols to constitute the Sub-Page image that shall be organized as shown on Figure 24.

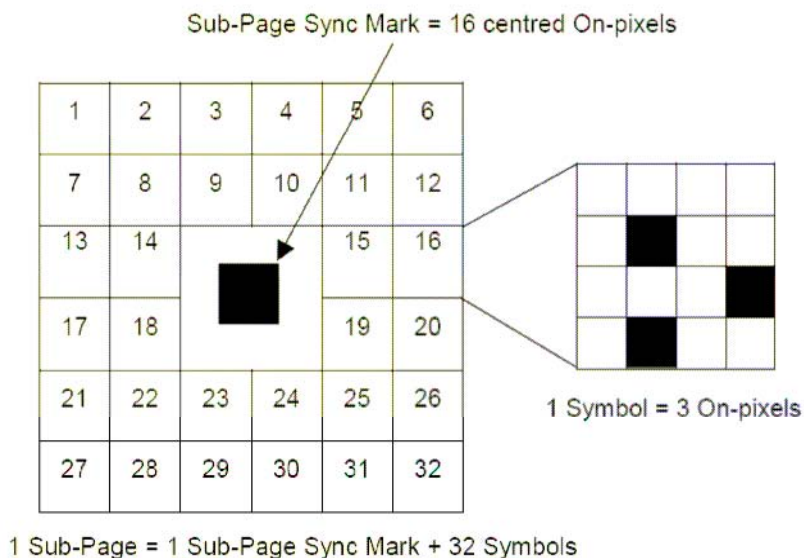
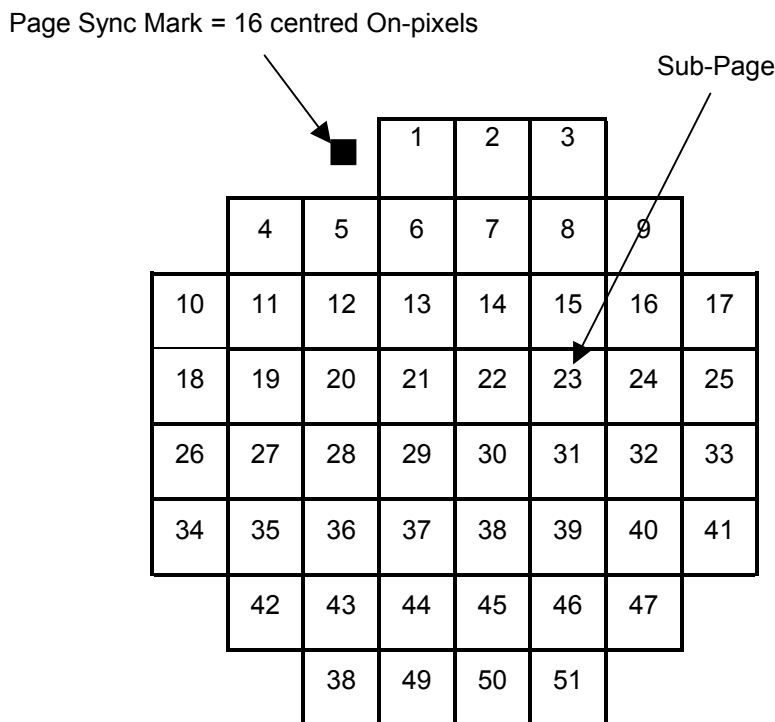

Figure 24 – Pixel Symbols organization of the content of a Sub-Page

A Page Sync Mark constituted of 16 On-pixels shall be added to 51 Sub-Pages to generate the Data Page image that shall be organized as shown on Figure 25.



1 Page = 1 Page Sync Mark + 51 Sub-Pages = 1 632 Kbytes

Figure 25 – Sub-Page organization of a Page

14.4 Data Page hologram - Reference Pattern

The Data Page image generated as specified in 14.3.2 shall be stored as a hologram in the storage layer in relation with the Reference Pattern specified in 9.3.2.

15 Division of the Formatted Zone

15.1 General description of the Formatted Zone

The Formatted Zone specified in 14.1.3 contains all information on the disk relevant for data interchange. This information comprises tracking/addressing/SDI provisions, and stored data. In this clause the term "data" is reserved for the content of the Data Page, which, in general, is transferred to the host.

Clause 15 defines the layout/content of the information. The characteristics of signals obtained from this information are specified in Sections 4 and 5.

15.2 Content/usage of the Formatted Zone

The Formatted Zone shall be structured and used as shown in Table 2.

Table 2 – Content/usage of the Formatted Zone

Content / usage	Zone number(s)	Pit track addresses (Decimal)	Pit track addresses (Hexadecimal)	Number of pit tracks	Number of hologram tracks
Lead-in Zone	0	-1 280 to -831	(FB00) to (FCC1)	450
Buffer Zone 1	0	-830 to -511	(FCC2) to (FE01)	320
Test Zone	0	-510 to -321	(FE02) to (FEBF)	190
Buffer Zone 2	0	-320 to -1	(FEC0) to (FFFF)	320
User data Zone	1 to 15	0 to 18 879	(0000) to (49BF)	18 880	2 360
Lead-out Zone	16	18 880 to 18 891 ¹	(49C0) to (49CB)	12	2

15.2.1 Zone 0 – Lead-in Zone / Buffer Zone 1 / Test Zone / Buffer Zone 2

The Zone 0 shall be divided in 4 Sub-Zones.

15.2.1.1 Lead-in Zone

The Lead-in Zone shall comprise 450 pit tracks.

The Lead-in Zone shall be used for storing the SDI.

15.2.1.2 Buffer Zone 1

The Buffer Zone 1 shall comprise 320 pit tracks.

15.2.1.3 Test Zone

The Test Zone shall comprise 190 pit tracks.

The Test Zone could be used for read tests. Its content is not specified by this Standard and shall be ignored in interchange.

15.2.1.4 Buffer Zone 2

The Buffer Zone 2 shall comprise 320 pit tracks.

15.2.2 Zones 1 to 15 - User data Zone

Zones 1 to 15 shall constitute the User data Zone used to store user data.

The User data Zone shall comprise 18 880 pit tracks corresponding to 2360 hologram tracks that may contain 95 760 000 holograms storing 86 552 308 user Data Pages.

The first user hologram on the disk shall be stored centred on pit Track 0.

15.2.3 Zone 16 - Lead-out Zone

The Lead-out Zone shall comprise 12 pit tracks corresponding to 2 hologram tracks.

The Lead-out Zone shall be used to store the finalizing data specified in Annex G. The specified Data Page shall be stored repetitively in the two hologram tracks of the Lead-out Zone.

Section 4 - Characteristics of the tracking/addressing and SDI information

16 Method of testing

The format of the pit tracking /addressing and SDI information on the disk is defined in Clause 13. Clause 17 specifies the requirements for the signals from the tracks, addresses and SDI, as obtained when using the Reference Drive specified in Clause 9.

16.1 Environment

All signals specified in Clause 17 shall be within their specified ranges with the disk in any environment in the range of allowed operating environments defined in 8.1.1.

16.2 Use of the Reference Drive

All signals specified in Clause 17 shall be measured in the indicated channel of the Reference Drive. The drive shall have the following characteristics for the purpose of these tests.

16.2.1 Optics and mechanics

The drive shall have a Tracking/Addressing Channel, with the implementation as given in 9.2.

The tracking/addressing beam shall have the properties defined in 9.2.1.

The disk shall rotate as specified in 9.4.4.

16.2.2 Tracking/addressing beam power

The tracking/addressing beam power shall be $0,5 \text{ mW} \pm 0,2 \text{ mW}$.

16.2.3 Tracking requirements

During the measurement of the signals, the focus of the beam shall follow the pit track with the requirements defined in Clause 9.4.1.

16.3 Definition of signals

Figure 26 shows the signals specified in Clause 17.

All signals are linearly related to currents I_1 and I_2 derived from the outputs of the split photodiode detector of the Reference Drive (see 9.1), and are therefore linearly related to the optical power falling on the detector.

The reading signal I provided by the Addressing Channel is the high bandwidth sum signal

$$I = I_1 + I_2$$

as processed by the band-pass filter described in Annex H1.

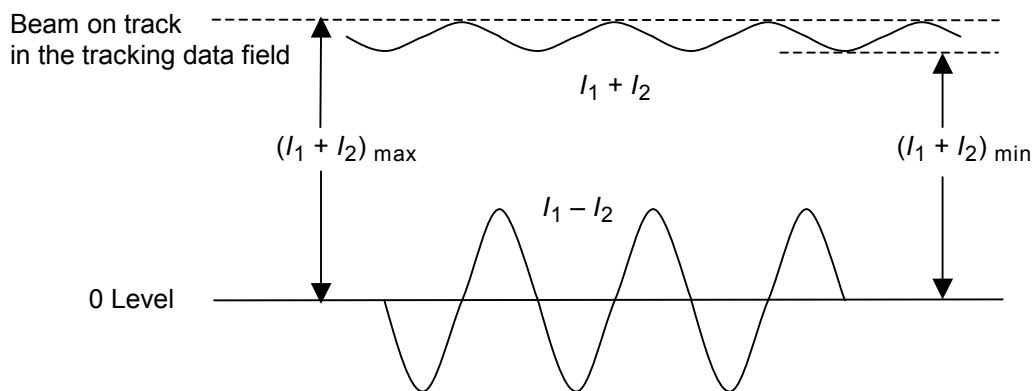

Figure 26a – Signals from the tracking data field

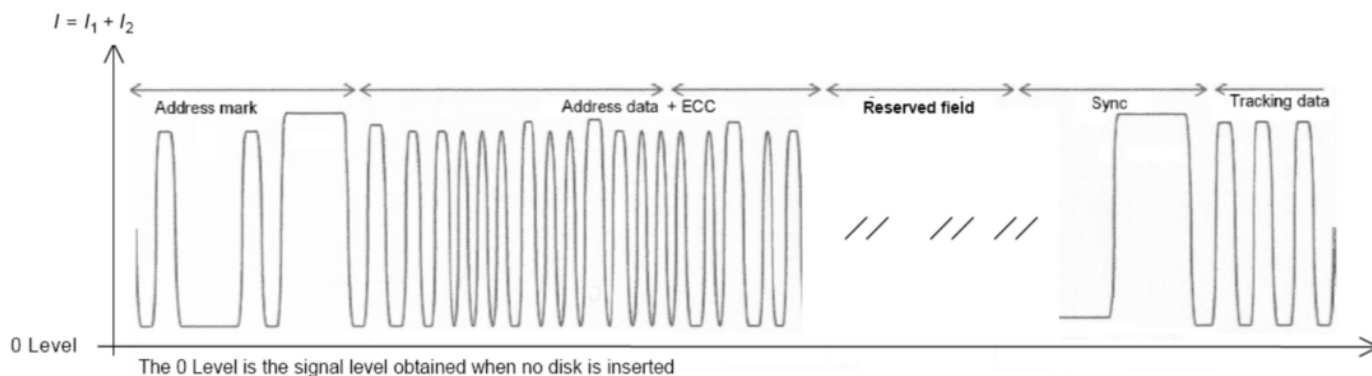

Figure 26b – Signal $I = I_1 + I_2$ in the different fields

Figure 26 – Illustration of the various parameters for tracking/addressing signal characteristics

17 Signal requirements

17.1 Reflectivity

The reflectivity is defined as the ratio of the upper level of signal $I = I_1 + I_2$ obtained from a 4T mark to the signal $I = I_1 + I_2$ obtained from a totally reflecting disk.

The reflectivity shall not be less than 18%.

17.2 Normalized Push Pull signal

The push-pull signal is the sinusoidal difference signal $(I_1 - I_2)$ in the Radial Tracking Channel, when the focus of the optical beam crosses the tracks. This signal can be used as error signal for radial tracking. The normalized peak-to-peak value of the push-pull signal shall meet the following requirement in the Formatted Zone:

$$0,4 \leq \frac{(I_1 - I_2)_{PP}}{(I_1 + I_2)_{av}} \leq 0,8$$

17.3 Modulation

The modulation of signal $I = I_1 + I_2$ is the ratio of its average peak-to-peak value to its average top value.

$$\text{Modulation} = \frac{(I_1 + I_2)_{PP}}{(I_1 + I_2)_{top\ av}}$$

The modulation shall not be less than 0,3 for the tracking data 4T marks.

17.4 Resolution

The resolution I_{nT} / I_{mT} is the ratio of the average peak-to-peak value I_{nT} of the signal obtained from nT pits and nT lands to the average peak-to-peak value of the signal I_{mT} obtained from mT pits and mT lands.

$$\text{Resolution } I_{nT} / I_{mT} = \frac{I_{nT\ PP\ av}}{I_{mT\ PP\ av}}$$

The resolution I_{2T} / I_{4T} shall not be less than 0,5 for the Address data or ECC 2T pits and tracking data 4T pits.

The resolution I_{16T} / I_{4T} shall not be less than 0,5 for the Sync 16T pits and tracking data 4T pits.

17.5 4Ttop modulation

The 4Ttop modulation is the ratio of the peak-to-peak variation value of the upper envelope of the signal obtained from 4T pits to its maximum upper level value.

$$4Ttop\ modulation = \frac{(I_{4T\ top})_{PP}}{(I_{4T\ top})_{max}}$$

The 4T top modulation shall be less than 10% on a disk revolution.

17.6 Asymmetry

The asymmetry (see Annex I) relates to the deviation of the centre levels of the signals of two distinct repeating pit and land patterns.

17.6.1 Asymmetry (4T - 2T)

The asymmetry (4T - 2T) shall be less than $\pm 10\%$ for the Address data or ECC 2T pits and tracking data 4T pits.

17.6.2 Asymmetry (16T - 4T)

The asymmetry (16T - 4T) shall be less than $\pm 10\%$ for the Sync 16T pits and tracking data 4T pits.

17.7 Jitter

Jitter is the standard deviation (sigma) of the time variation of the digitized data.

The jitter of the 4T pits and lands, measured as a percentage of the nominal pits and lands durations, shall be less than 8%.

17.8 Phase depth

The phase depth of pits

$$\frac{n \times d}{\lambda_T} \times 360^\circ$$

where n is the index of refraction of the cover layer, d is the pit depth, and λ_T is the wavelength of the tracking/addressing laser, shall be less than 90°.

Section 5 - Characteristics of user data

18 User data – Method of testing

Clauses 18 and 19 describe measurements to test conformance of the stored data on the disk with this Ecma Standard. It checks the legibility of stored data. The stored data is assumed to be arbitrary. The read tests shall be performed on the Reference Drive.

The requirements in Clauses 18 and 19 define a minimum quality of the data, necessary for data interchange.

18.1 Environment

All specifications of Clauses 19 and 20 shall be verified with the disk in any environment in the range of allowed operating environments defined in 8.1.1.

18.2 Reference Drive

All specifications of Clauses 19 and 20 shall be measured in the Reference Drive. The drive shall have the following characteristics for the purpose of these tests:

18.2.1 Optics and mechanics

The reference drive shall have Tracking/Addressing and Reading Channels as given in 9.2 and 9.3.

The Reference Pattern used to read the data image shall be as specified in 9.3.2.

The disk shall rotate as specified in 9.4.4.

18.2.2 Tracking/addressing reading power

The tracking/addressing reading power shall be $0,5 \text{ mW} \pm 0,2 \text{ mW}$.

18.2.3 Data reading energy

The data reading energy shall be as specified in the SDI (see Annex D).

18.2.4 Tracking requirements

During the measurement of the signals, the focus of the tracking/addressing beam shall follow the pit track with the requirements defined in 9.4.1.

18.2.5 Relative positioning of the focus of the data reading beam and the tracking/addressing beam

During data reading, the relative positioning of the centres of the focus of the data reading beam and the tracking/addressing beam shall be as specified in Clause 9.4.2.

18.2.6 Data detection for testing purposes

Data shall be detected for testing purposes as specified in Annex H2.

19 Minimum quality of a Data Page

This clause specifies the minimum quality of a Data Page as required for interchange of the data contained in that page. The quality shall be measured on the Reference Drive specified in 18.2.

A byte error occurs when one or more bits in a byte have a wrong setting, as detected by ECC circuits.

The stored data in a Data Page shall not contain any byte errors that cannot be corrected by the error correction circuit.

19.1 Reading energy damage

Stored data shall not become damaged due to the repetitive reading of pages. Media shall be tested against reading energy damage.

No error shall appear after ECC decoding after 1 million readouts.

20 Data interchange requirements

A disk offered for interchange of data shall comply with the following requirements.

20.1 Tracking

The focus of the optical beam shall not jump pit tracks unintentionally.

20.2 Stored data

Data for interchange shall be stored anywhere within the User data Zone.

20.3 User-read data

Any stored Page shall not contain byte errors during reading, after the error correction circuit.

Annex A (normative)

Measurement of light reflectance

A.1 Calibration method

A good reference disk shall be chosen, for instance a glass disk with a golden reflective mirror. This reference disk shall be measured by a parallel beam as shown in Figure A.1

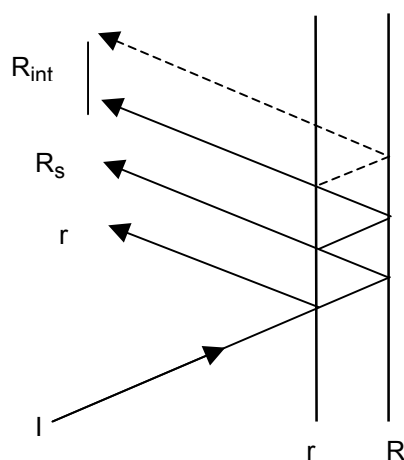

Figure A.1 - Reflectance calibration

In this figure the following applies.

I = incident beam

r = reflectance of the entrance surface

R_s = main reflectance of the measured reflective layer

R_{int} = other reflectance's of the entrance surface and of the measured reflective layer

$R_{//}$ = measured value, using the arrangement of Figure A.1

$$R_{//} = r + R_s + R_{int}$$

$$r = \left(\frac{n-1}{n+1} \right)^2 \quad \text{where } n \text{ is the refraction index of the cover layer}$$

$$R_s = R_{//} - r - R_{int}$$

$$R_s = \frac{[(1-r)^2 \times (R_{//} - r)]}{[1-r \times (2 - R_{//})]}$$

The reference disk shall be measured on a reference drive and I_{mirror} measured by the focused beam is equated to R_s as determined above.

Now the arrangement is calibrated and the focused reflectivity is a linear function of the reflectivity of the measured reflective layer, independently from the reflectivity of the entrance surface.

A.2 Measuring method

The measuring method comprises the following steps.

- a) Measure the reflective light power D_s from the reference disk with calibrated reflectivity R_s
- b) Measure I_{xx} in a defined area of the disk.
- c) Calculate the reflectivity as follows

$$R_{xx} = R_s \times \frac{I_{xx}}{D_s}$$

Annex B (normative)

Measurement of birefringence

B.1 Principle of the measurement

In order to measure the birefringence, circularly polarized light in a parallel beam is used. The phase retardation is measured by observing the ellipticity of the reflected light.

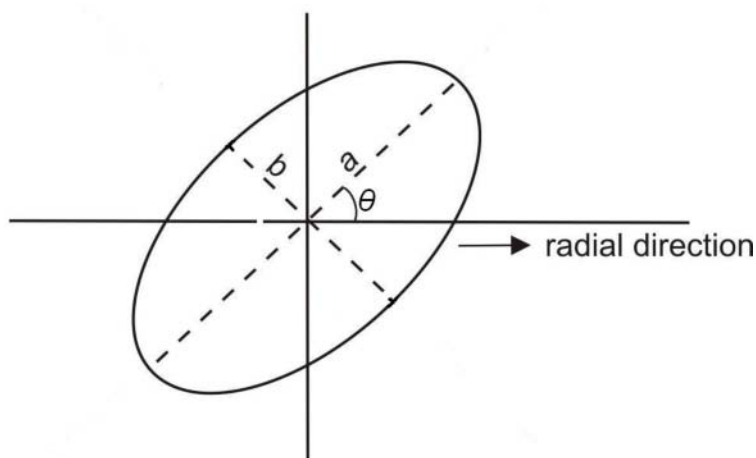

97-0008-A

Figure B.1 - Ellipse with ellipticity $e = b/a$ and orientation θ

The orientation θ of the ellipse is determined by the orientation of the optical axis

$$\theta = \gamma - \pi/4 \quad (I)$$

where γ is the angle between the optical axis and the radial direction.

The ellipticity $e = b/a$ is a function of the phase retardation δ

$$e = \tan \left[\frac{1}{2} \left(\frac{\pi}{2} - \delta \right) \right] \quad (II)$$

When the phase retardation δ is known the birefringence BR can be expressed as a fraction of the wavelength

$$BR = \frac{\lambda}{2\pi} \delta \text{ nm} \quad (III)$$

Thus, by observing the elliptically polarized light reflected from the disk, the birefringence can be measured and the orientation of the optical axis can be assessed as well.

B.2 Measurements conditions

The measurement of the birefringence specified above shall be made under the following conditions:

Mode of measurement in reflection

double pass through the specified stack of layers

Wavelength λ of the laser light	λ_T or λ_R nm \pm 15 nm
Beam diameter (Full width half maximum)	1,0 mm \pm 0,2 mm
Angle β of incidence in radial direction relative to the radial plane perpendicular to Reference Plane P	$7,0^\circ \pm 0,2^\circ$
Clamping and chucking conditions	as specified in 11.2 and 11.3
Disk mounting	horizontally
Rotation	less than 1 Hz
Temperature and relative humidity	as specified in 8.1.1

B.3 Example of a measuring set-up

Whilst this Ecma Standard does not prescribe a specific device for measuring birefringence, the device shown schematically in Figure B.2 as an example, is well suited for this measurement.

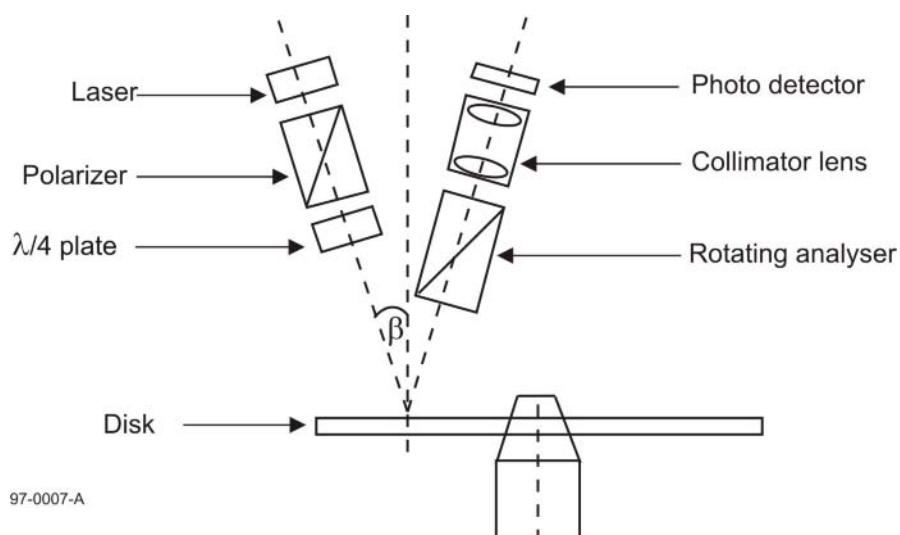

Figure B.2 - Example of a device for the measurement of birefringence

Light from a laser source, collimated into a polarizer (extinction ratio $\approx 10^{-5}$), is made circular by a $\lambda/4$ plate. The ellipticity of the reflected light is analyzed by a rotating analyser and a photo detector. For every location on the disk, the minimum and the maximum values of the intensity I are measured. The ellipticity can then be calculated as

$$e^2 = I_{\min} / I_{\max} \quad (IV)$$

Combining equations II, III and IV yields

$$BR = \lambda / 4 - \lambda / \pi \times \arctang \sqrt{\frac{I_{\min}}{I_{\max}}}$$

This device can be easily calibrated as follows

- I_{\min} is set to 0 by measuring a polarizer or a $\lambda/4$ plate,
- $I_{\min} = I_{\max}$ when measuring a mirror.

Apart of the d.c. contribution of the front surface reflection, a.c. components may occur, due to the interference of the reflection(s) of the front surface with the reflection(s) from the internal layers. These a.c. reflectance effects are significant only if the disk substrate has an extremely accurate flatness and if the light source has a high coherence.



Annex C (normative)

Tapered cone for disk clamping

The device used for centring the disk for measurement shall be a cone with a taper angle $\beta = 40,0^\circ \pm 0,5^\circ$ (see Figure C.1).

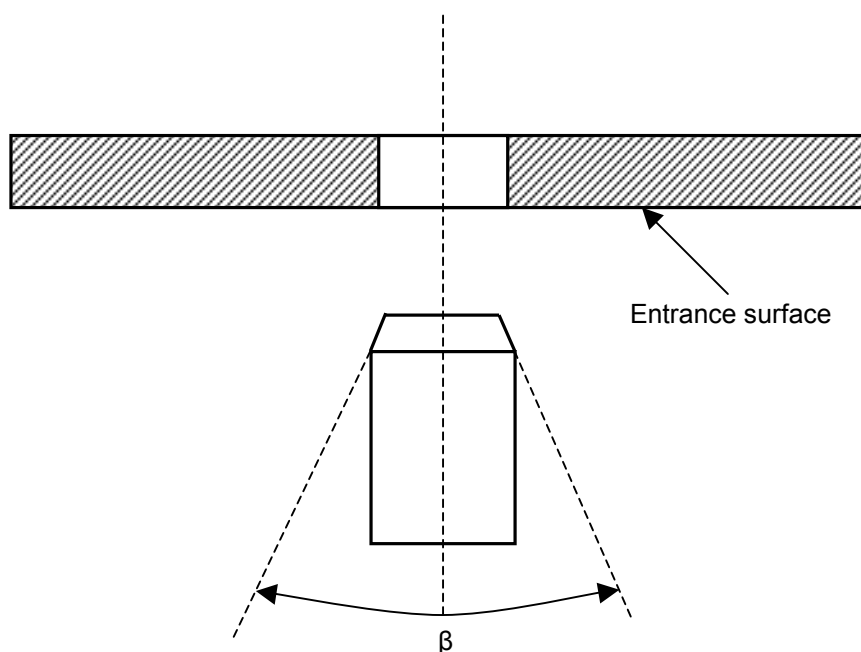

Figure C.1 - Tapered cone



Annex D (normative)

Specific Disk Information

The Specific Disk Information (SDI) recorded in the tracking data area of the Lead-in tracks shall contain the items/parameters listed in Table D.1.

Format, number of bytes and position in the tracks of each item/parameter shall be as specified in the table.

Table D.1 – SDI content

Pit Track number		Pit Sector number		Start Channel bit		Items	Format / Meaning	Bytes				
DEC	HEX	DEC	HEX	DEC	HEX							
-1 280	FB00	0	00	224	00E0	Version of disk format	2 / HVD-ROM 100 GB	2				
				256	0100	Version of Specific Disk Information (SDI)	n / (Version n) x 100	2				
				288	0120	Disk category	2 / HVD-ROM	2				
				320	0140	Disk size	1 / 120 mm	2				
				352	0160	Disk capacity	n / n Gbytes	2				
				384	0180	Reserved	Set to Zero	14				
				608	0260	Hologram read energy	n / n nanoJoules	2				
				640	0280	Write strategy	1 / Sequential	1				
				656	0290	Reserved	Set to Zero	116				
				2 512	09D0							
				1	01	224	00E0	Reserved	Set to Zero	143		
						2 512	09D0					
				2	02	224	00E0	Reserved	Set to Zero	143		
						2 512	09D0					
:	:	:	:	:	:	:						
199	C7	224	00E0	Reserved	Set to Zero	143						
		2 512	09D0									
-1 279	FB01	0	00	224	00E0	Repeat of Channel bits 224 to 655		27				
				656	0290	Reserved	Set to Zero	116				
				2 512	09D0							
				1	01	224	00E0	Reserved	Set to Zero	143		
						2 512	09D0					
				2	02	224	00E0	Reserved	Set to Zero	143		
						2 512	09D0					
				:	:	:	:	:	:	:		
				199	C7	224	00E0	Reserved	Set to Zero	143		
						2 512	09D0					
				:	:	:	:	:	:	:		
				-1 231	FB31	0	00	224	00E0	Repeat of Channel bits 224 to 655		27
								656	0290	Reserved	Set to Zero	116
								2 512	09D0			
1	01	224	00E0					Reserved	Set to Zero	143		
		2 512	09D0									
2	02	224	00E0					Reserved	Set to Zero	143		
		2 512	09D0									
:	:	:	:					:	:	:		
199	C7	224	00E0					Reserved	Set to Zero	143		
		2 512	09D0									
:	:	:	:					:	:	:		
-1 230	FB32	Repeat of tracks -1 280 to -1 231										
-1 181	FB63	Repeat of tracks -1 280 to -1 231										
-1 180	FB64	Repeat of tracks -1 280 to -1 231										
:	:	Repeat of tracks -1 280 to -1 231										
-1 131	FB95	Repeat of tracks -1 280 to -1 231										

* NOTE: The Channel bits of each Sector are numbered from 1 to 2 520.



Annex E (normative)

ECC

The codes used to generate the Inter-Page and Intra-Page ECC bytes shall be as specified in this annex.

E.1 Inter- Page ECC

The 1 068 bytes of the 188 packets described in Clause 14.2.4.1 shall be processed by a Reed-Solomon code (255,235,20) to generate 20 packets of 1 068 Inter-Page ECC bytes, as shown on figure E.1.

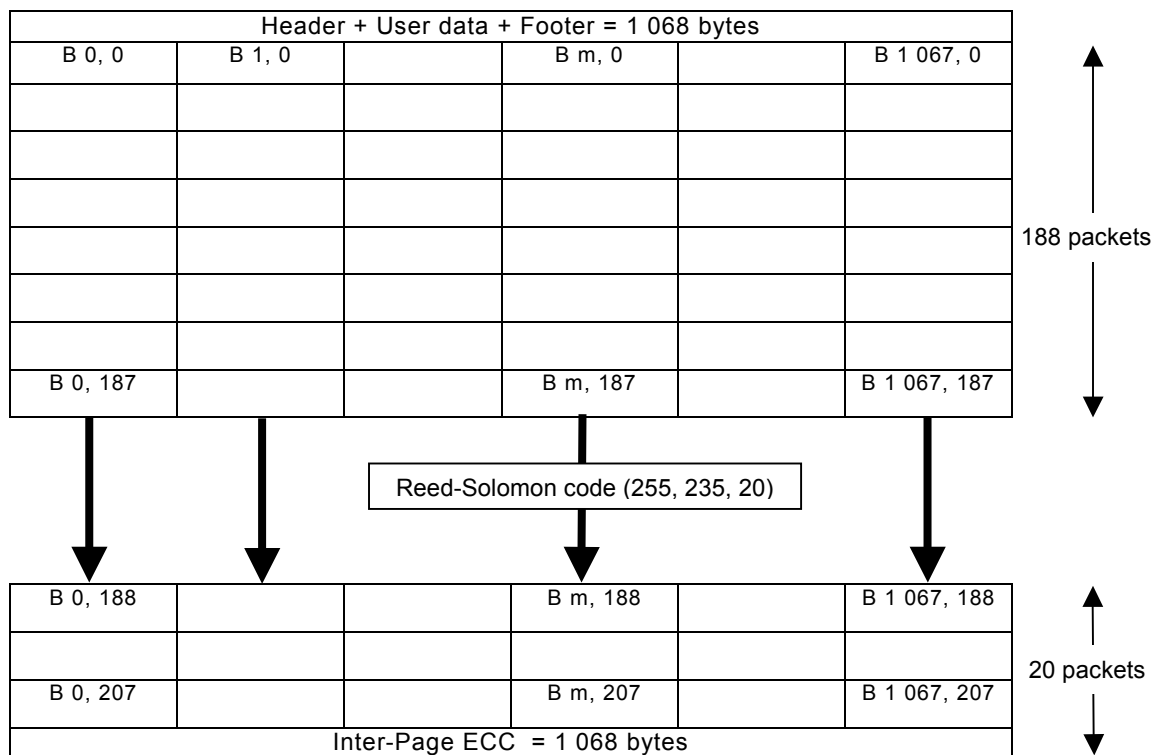

Figure E.1 – Generation of the Inter-Page ECC bytes

E.2 Intra-Page ECC

The 1 072 bytes packets of Clause 14.2.4.1 corresponding to User data + Inter-Page ECC bytes shall be first converted in 2 144 bytes packets through the 8 to 16 bits conversion table shown in Figure E.2.

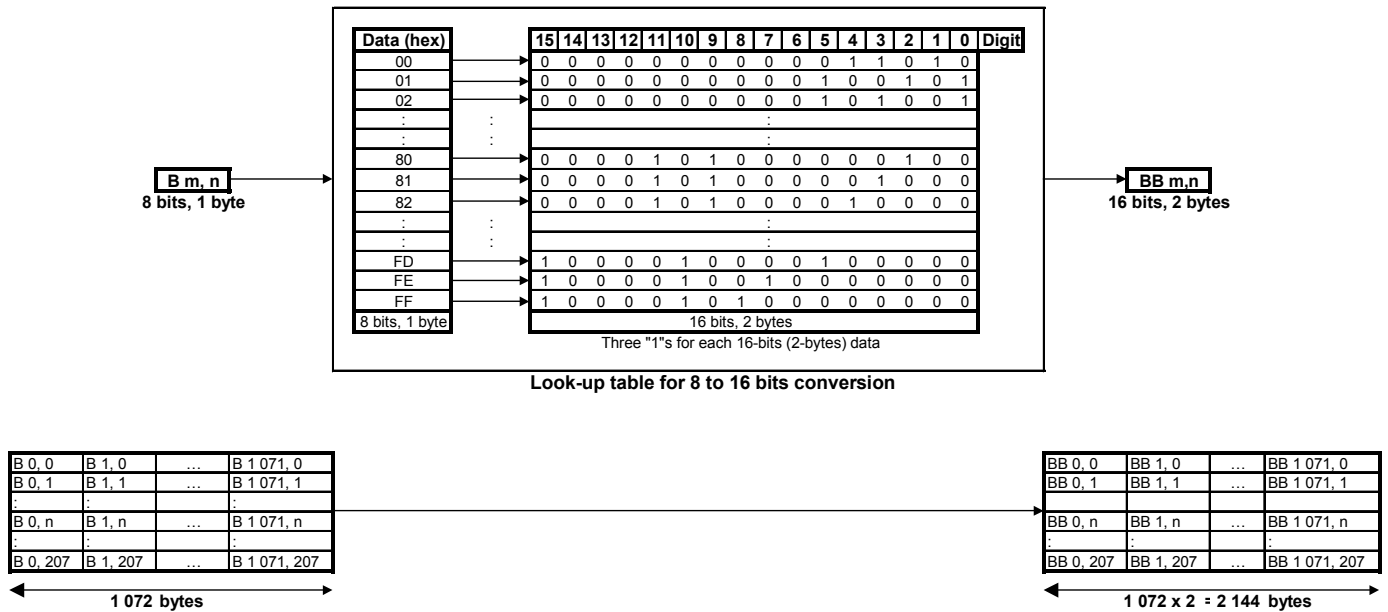

Figure E.2 – 8 to 16 bits conversion

These 2 144 bytes packets shall be then processed by the ECC/LDPC encoding of figure E.3a, E.3b and E.3c to generate 560 Intra-Page ECC bytes added to each of the initial 1 072 bytes packets.

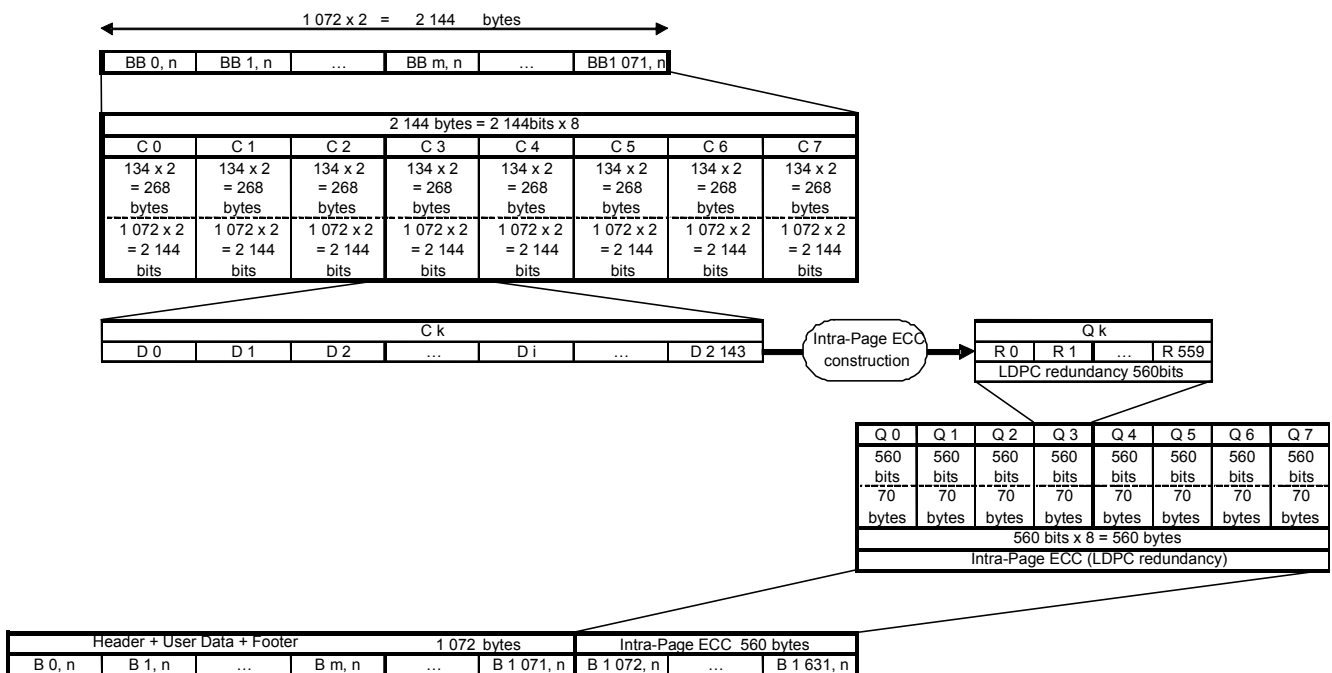

Figure E.3a – Generation of the Intra-Page ECC bytes

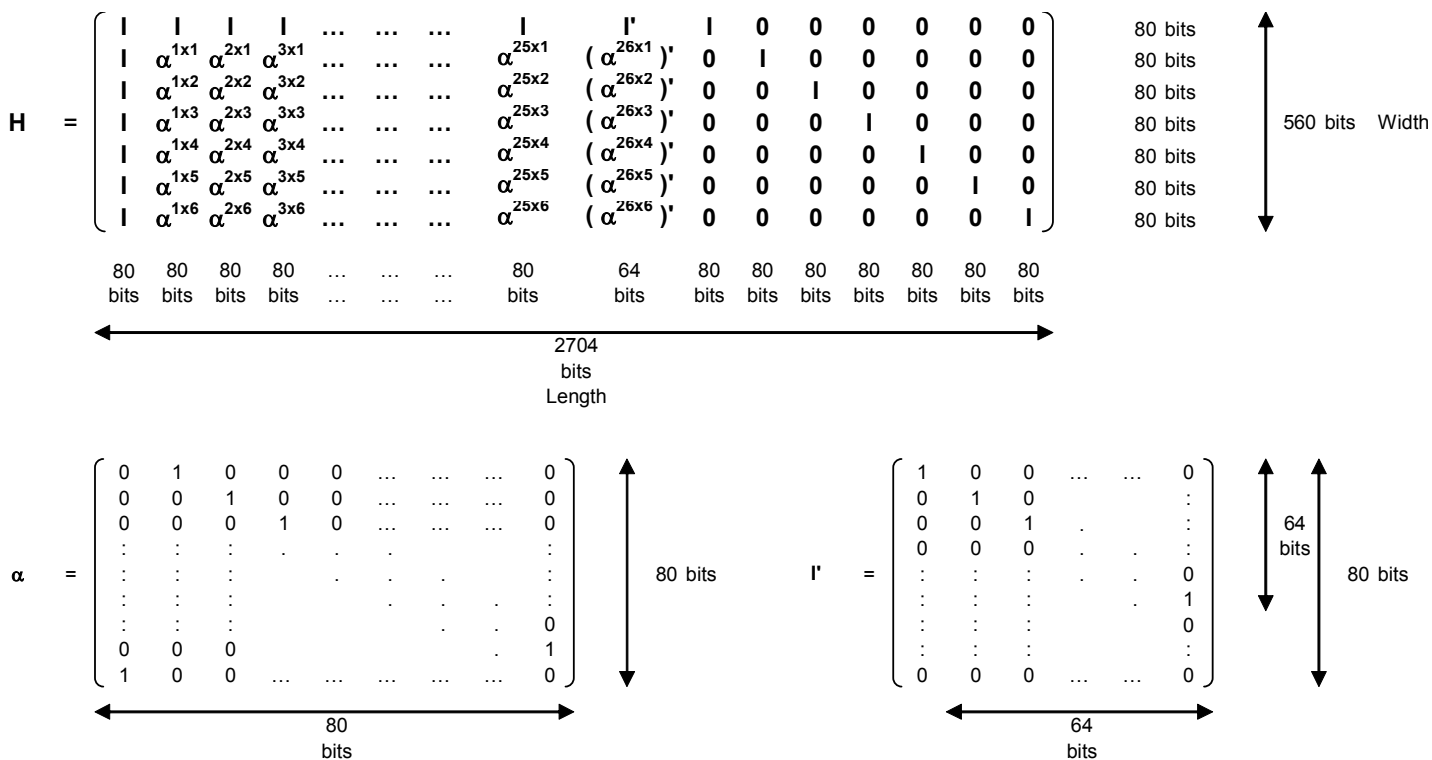

Figure E.3b – Intra-Page ECC code structure

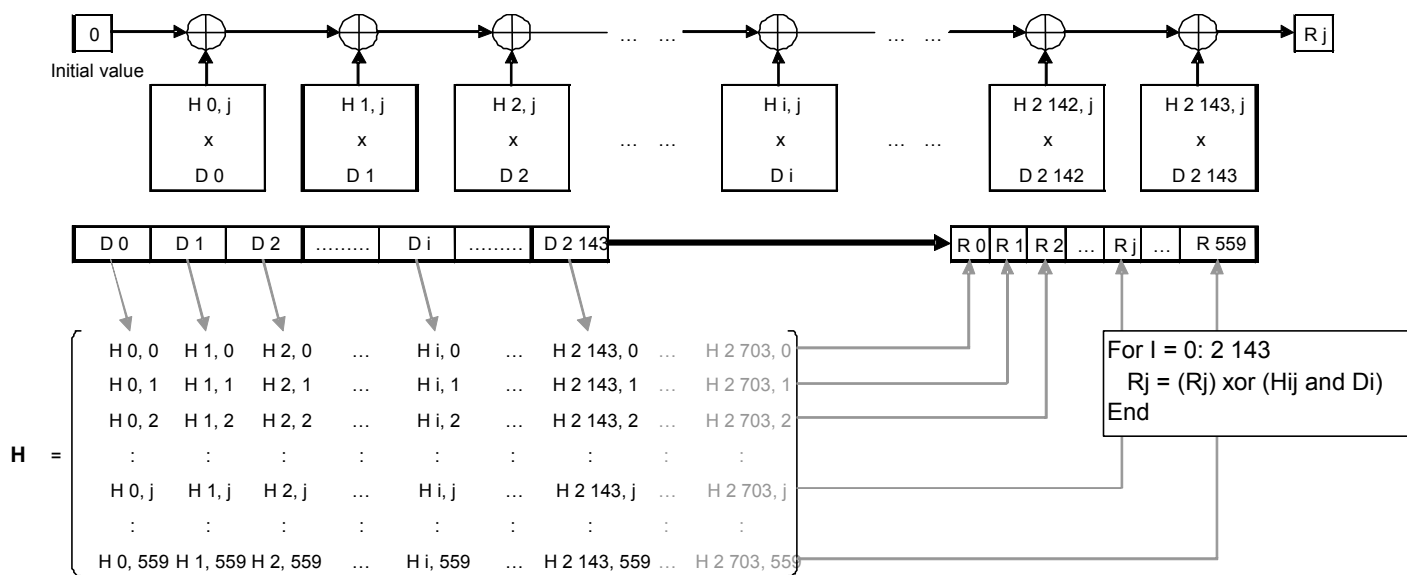

Figure E.3c – Intra-Page ECC code structure



Annex F **(normative)**

16 bits to Symbols conversion look-up table

The conversion of the 16-bits data in Symbols and Symbols to 16-bits data shall be done as shown in Table F.1.

Bits to One shall correspond to ON (illuminated) pixels.

Bits to Zero shall correspond to Off (non-illuminated) pixels.

Table F.1 – 16-bits data to Symbols conversion

symbol	code (binary)				data		
	(dec)	(hex)	(dec)				
	0 0 0 0	0 0 0 0	0 0 0 0	1 1 0 1 0	26	00	0
	0 0 0 0	0 0 0 0	0 0 1 0	0 1 0 1	37	01	1
	0 0 0 0	0 0 0 0	0 0 1 0	1 0 0 1	41	02	2
	0 0 0 0	0 0 0 0	0 1 0 0	1 0 0 1	73	03	3
	0 0 0 0	0 0 0 0	0 1 0 0	1 0 1 0	74	04	4
	0 0 0 0	0 0 0 0	0 1 0 1	0 0 1 0	82	05	5
	0 0 0 0	0 0 0 0	0 1 0 1	1 0 0 0	88	06	6
	0 0 0 0	0 0 0 0	1 0 0 0	0 1 0 1	133	07	7
	0 0 0 0	0 0 0 0	1 0 0 1	0 0 1 0	146	08	8
	0 0 0 0	0 0 0 0	1 0 0 1	0 1 0 0	148	09	9
	0 0 0 0	0 0 0 0	1 0 1 0	0 0 0 1	161	0A	10
	0 0 0 0	0 0 0 0	1 0 1 0	0 1 0 0	164	0B	11
	0 0 0 0	0 0 0 0	1 0 0 0	0 1 0 1	261	0C	12
	0 0 0 0	0 0 0 0	1 0 0 0	1 0 0 1	265	0D	13
	0 0 0 0	0 0 0 0	1 0 0 0	1 0 1 0	266	0E	14
	0 0 0 0	0 0 0 0	1 0 0 1	0 0 0 1	289	0F	15
	0 0 0 0	0 0 0 0	1 0 0 1	0 1 0 0	292	10	16
	0 0 0 0	0 0 0 0	1 0 0 1	1 0 0 0	296	11	17

Table F.1 – 16-bits data to Symbols conversion



















	0 0 0 0	0 0 0 1	0 1 0 0	0 0 0 1	321	12	18
	0 0 0 0	0 0 0 1	0 1 0 0	0 0 1 0	322	13	19
	0 0 0 0	0 0 0 1	0 1 0 0	1 0 0 0	328	14	20
	0 0 0 0	0 0 0 1	1 0 0 0	0 0 0 1	385	15	21
	0 0 0 0	0 0 0 1	1 0 0 0	0 0 1 0	386	16	22
	0 0 0 0	0 0 0 1	1 0 0 0	0 1 0 0	388	17	23
	0 0 0 0	0 0 0 1	1 0 1 0	0 0 0 0	416	18	24
	0 0 0 0	0 0 1 0	0 0 0 0	0 1 0 1	517	19	25
	0 0 0 0	0 0 1 0	0 0 0 0	1 0 0 1	521	1A	26
	0 0 0 0	0 0 1 0	0 0 0 0	1 0 1 0	522	1B	27
	0 0 0 0	0 0 1 0	0 0 0 1	0 0 1 0	530	1C	28
	0 0 0 0	0 0 1 0	0 0 0 1	0 1 0 0	532	1D	29
	0 0 0 0	0 0 1 0	0 0 0 1	1 0 0 0	536	1E	30
	0 0 0 0	0 0 1 0	0 1 0 0	0 0 0 1	577	1F	31
	0 0 0 0	0 0 1 0	0 1 0 0	0 0 1 0	578	20	32
	0 0 0 0	0 0 1 0	0 1 0 0	1 0 0 0	584	21	33
	0 0 0 0	0 0 1 0	0 1 0 1	0 0 0 0	592	22	34
	0 0 0 0	0 0 1 0	1 0 0 0	0 0 0 1	641	23	35
	0 0 0 0	0 0 1 0	1 0 0 0	0 0 1 0	642	24	36

Table F.1 – 16-bits data to Symbols conversion



















	0 0 0 0	0 0 1 0	1 0 0 0	0 1 0 0	644	25	37
	0 0 0 0	0 0 1 0	1 0 0 1	0 0 0 0	656	26	38
	0 0 0 0	0 1 0 0	0 0 0 0	0 1 0 1	1029	27	39
	0 0 0 0	0 1 0 0	0 0 0 0	1 0 0 1	1033	28	40
	0 0 0 0	0 1 0 0	0 0 0 0	1 0 1 0	1034	29	41
	0 0 0 0	0 1 0 0	0 0 0 1	0 0 1 0	1042	2A	42
	0 0 0 0	0 1 0 0	0 0 0 1	0 1 0 0	1044	2B	43
	0 0 0 0	0 1 0 0	0 0 0 1	1 0 0 0	1046	2C	44
	0 0 0 0	0 1 0 0	0 0 1 0	0 0 0 1	1057	2D	45
	0 0 0 0	0 1 0 0	0 0 1 0	0 1 0 0	1060	2E	46
	0 0 0 0	0 1 0 0	0 0 1 0	1 0 0 0	1064	2F	47
	0 0 0 0	0 1 0 0	1 0 0 0	0 0 0 1	1153	30	48
	0 0 0 0	0 1 0 0	1 0 0 0	0 0 1 0	1154	31	49
	0 0 0 0	0 1 0 0	1 0 0 0	0 1 0 0	1156	32	50
	0 0 0 0	0 1 0 0	1 0 0 1	0 0 0 0	1168	33	51
	0 0 0 0	0 1 0 0	1 0 1 0	0 0 0 0	1184	34	52
	0 0 0 0	0 1 0 1	0 0 0 0	0 0 0 1	1281	35	53
	0 0 0 0	0 1 0 1	0 0 0 0	0 0 1 0	1282	36	54
	0 0 0 0	0 1 0 1	0 0 0 0	0 1 0 0	1284	37	55

Table F.1 – 16-bits data to Symbols conversion



















	0 0 0 0	0 1 0 1	0 0 0 0	1 0 0 0	1288	38	56
	0 0 0 0	0 1 0 1	0 0 1 0	0 0 0 0	1312	39	57
	0 0 0 0	0 1 0 1	1 0 0 0	0 0 0 0	1408	3A	58
	0 0 0 0	1 0 0 0	0 0 0 0	0 1 0 1	2053	3B	59
	0 0 0 0	1 0 0 0	0 0 0 0	1 0 0 1	2057	3C	60
	0 0 0 0	1 0 0 0	0 0 0 0	1 0 1 0	2058	3D	61
	0 0 0 0	1 0 0 0	0 0 0 1	0 0 1 0	2066	3E	62
	0 0 0 0	1 0 0 0	0 0 0 1	0 1 0 0	2068	3F	63
	0 0 0 0	1 0 0 0	0 0 0 1	1 0 0 0	2072	40	64
	0 0 0 0	1 0 0 0	0 0 1 0	0 0 0 1	2081	41	65
	0 0 0 0	1 0 0 0	0 0 1 0	0 1 0 0	2084	42	66
	0 0 0 0	1 0 0 0	0 0 1 0	1 0 0 0	2088	43	67
	0 0 0 0	1 0 0 0	0 1 0 0	0 0 0 1	2113	44	68
	0 0 0 0	1 0 0 0	0 1 0 0	0 0 1 0	2114	45	69
	0 0 0 0	1 0 0 0	0 1 0 0	1 0 0 0	2120	46	70
	0 0 0 0	1 0 0 0	0 1 0 1	0 0 0 0	2128	47	71
	0 0 0 0	1 0 0 1	0 0 0 0	0 0 0 1	2305	48	72
	0 0 0 0	1 0 0 1	0 0 0 0	0 0 1 0	2306	49	73
	0 0 0 0	1 0 0 1	0 0 0 0	0 1 0 0	2308	4A	74

Table F.1 – 16-bits data to Symbols conversion

	0 0 0 0	1 0 0 1	0 0 0 0	1 0 0 0	2312	4B	75
	0 0 0 0	1 0 0 1	0 0 1 0	0 0 0 0	2336	4C	76
	0 0 0 0	1 0 0 1	0 1 0 0	0 0 0 0	2368	4D	77
	0 0 0 0	1 0 1 0	0 0 0 0	0 0 0 1	2561	4E	78
	0 0 0 0	1 0 1 0	0 0 0 0	0 0 1 0	2562	4F	79
	0 0 0 0	1 0 1 0	0 0 0 0	0 1 0 0	2564	50	80
	0 0 0 0	1 0 1 0	0 0 0 0	1 0 0 0	2568	51	81
	0 0 0 0	1 0 1 0	0 0 0 1	0 0 0 0	2576	52	82
	0 0 0 0	1 0 1 0	0 1 0 0	0 0 0 0	2624	53	83
	0 0 0 0	0 0 0 0	0 0 0 0	0 1 0 1	4101	54	84
	0 0 0 0	0 0 0 0	0 0 0 0	1 0 0 1	4105	55	85
	0 0 0 0	0 0 0 0	0 0 0 0	1 0 1 0	4106	56	86
	0 0 0 0	0 0 0 0	0 0 0 1	0 0 1 0	4114	57	87
	0 0 0 0	0 0 0 0	0 0 0 1	0 1 0 0	4116	58	88
	0 0 0 0	0 0 0 0	0 0 0 1	1 0 0 0	4120	59	89
	0 0 0 0	0 0 0 0	0 0 1 0	0 0 0 1	4129	5A	90
	0 0 0 0	0 0 0 0	0 0 1 0	0 1 0 0	4132	5B	91
	0 0 0 0	0 0 0 0	0 0 1 0	1 0 0 0	4136	5C	92
	0 0 0 0	0 0 0 0	0 1 0 0	0 0 0 1	4161	5D	93

Table F.1 – 16-bits data to Symbols conversion

	0 0 0 1	0 0 0 0	0 1 0 0	0 0 1 0	4162	5E	94
	0 0 0 1	0 0 0 0	0 1 0 0	1 0 0 0	4168	5F	95
	0 0 0 1	0 0 0 0	0 1 0 1	0 0 0 0	4176	60	96
	0 0 0 1	0 0 0 0	1 0 0 0	0 0 0 1	4225	61	97
	0 0 0 1	0 0 0 0	1 0 0 0	0 0 1 0	4226	62	98
	0 0 0 1	0 0 0 0	1 0 0 0	0 1 0 0	4228	63	99
	0 0 0 1	0 0 0 0	1 0 0 1	0 0 0 0	4240	64	100
	0 0 0 1	0 0 0 0	1 0 1 0	0 0 0 0	4256	65	101
	0 0 0 1	0 0 1 0	0 0 0 0	0 0 0 1	4609	66	102
	0 0 0 1	0 0 1 0	0 0 0 0	0 0 1 0	4610	67	103
	0 0 0 1	0 0 1 0	0 0 0 0	0 1 0 0	4612	68	104
	0 0 0 1	0 0 1 0	0 0 0 0	1 0 0 0	4616	69	105
	0 0 0 1	0 0 1 0	0 0 0 1	0 0 0 0	4624	6A	106
	0 0 0 1	0 0 1 0	0 1 0 0	0 0 0 0	4672	6B	107
	0 0 0 1	0 0 1 0	1 0 0 0	0 0 0 0	4736	6C	108
	0 0 0 1	0 1 0 0	0 0 0 0	0 0 0 1	5121	6D	109
	0 0 0 1	0 1 0 0	0 0 0 0	0 0 1 0	5122	6E	110
	0 0 0 1	0 1 0 0	0 0 0 0	0 1 0 0	5124	6F	111
	0 0 0 1	0 1 0 0	0 0 0 0	1 0 0 0	5128	70	112

Table F.1 – 16-bits data to Symbols conversion



















	0 0 0 1	0 1 0 0	0 0 0 1	0 0 0 0	5136	71	113
	0 0 0 1	0 1 0 0	0 0 1 0	0 0 0 0	5152	72	114
	0 0 0 1	0 1 0 0	1 0 0 0	0 0 0 0	5248	73	115
	0 0 0 1	1 0 0 0	0 0 0 0	0 0 0 1	6145	74	116
	0 0 0 1	1 0 0 0	0 0 0 0	0 0 1 0	6146	75	117
	0 0 0 1	1 0 0 0	0 0 0 0	0 1 0 0	6148	76	118
	0 0 0 1	1 0 0 0	0 0 0 0	1 0 0 0	6152	77	119
	0 0 0 1	1 0 0 0	0 0 0 1	0 0 0 0	6160	78	120
	0 0 0 1	1 0 0 0	0 0 1 0	0 0 0 0	6176	79	121
	0 0 0 1	1 0 0 0	0 1 0 0	0 0 0 0	6208	7A	122
	0 0 0 1	1 0 1 0	0 0 0 0	0 0 0 0	6656	7B	123
	0 0 1 0	0 0 0 0	0 0 0 0	0 1 0 1	8197	7C	124
	0 0 1 0	0 0 0 0	0 0 0 0	1 0 0 1	8201	7D	125
	0 0 1 0	0 0 0 0	0 0 0 0	1 0 1 0	8202	7E	126
	0 0 1 0	0 0 0 0	0 0 0 1	0 0 1 0	8210	7F	127
	0 0 1 0	0 0 0 0	0 0 0 1	0 1 0 0	8212	80	128
	0 0 1 0	0 0 0 0	0 0 0 1	1 0 0 0	8216	81	129
	0 0 1 0	0 0 0 0	0 0 1 0	0 0 0 1	8225	82	130
	0 0 1 0	0 0 0 0	0 0 1 0	0 1 0 0	8228	83	131

Table F.1 – 16-bits data to Symbols conversion



















	0 0 1 0	0 0 0 0	0 0 1 0	1 0 0 0	8232	84	132
	0 0 1 0	0 0 0 0	0 1 0 0	0 0 0 1	8257	85	133
	0 0 1 0	0 0 0 0	0 1 0 0	0 0 1 0	8258	86	134
	0 0 1 0	0 0 0 0	0 1 0 0	1 0 0 0	8264	87	135
	0 0 1 0	0 0 0 0	0 1 0 1	0 0 0 0	8272	88	136
	0 0 1 0	0 0 0 0	1 0 0 0	0 0 0 1	8321	89	137
	0 0 1 0	0 0 0 0	1 0 0 0	0 0 1 0	8322	8A	138
	0 0 1 0	0 0 0 0	1 0 0 0	0 1 0 0	8324	8B	139
	0 0 1 0	0 0 0 0	1 0 0 1	0 0 0 0	8336	8C	140
	0 0 1 0	0 0 0 0	1 0 1 0	0 0 0 0	8352	8D	141
	0 0 1 0	0 0 0 1	0 0 0 0	0 0 0 1	8449	8E	142
	0 0 1 0	0 0 0 1	0 0 0 0	0 0 1 0	8450	8F	143
	0 0 1 0	0 0 0 1	0 0 0 0	0 1 0 0	8452	90	144
	0 0 1 0	0 0 0 1	0 0 0 0	1 0 0 0	8456	91	145
	0 0 1 0	0 0 0 1	0 0 1 0	0 0 0 0	8480	92	146
	0 0 1 0	0 0 0 1	0 1 0 0	0 0 0 0	8512	93	147
	0 0 1 0	0 0 0 1	1 0 0 0	0 0 0 0	8576	94	148
	0 0 1 0	0 1 0 0	0 0 0 0	0 0 0 1	9217	95	149
	0 0 1 0	0 1 0 0	0 0 0 0	0 0 1 0	9218	96	150

Table F.1 – 16-bits data to Symbols conversion



















	0 0 1 0	0 1 0 0	0 0 0 0	0 1 0 0	9220	97	151
	0 0 1 0	0 1 0 0	0 0 0 0	1 0 0 0	9224	98	152
	0 0 1 0	0 1 0 0	0 0 0 1	0 0 0 0	9232	99	153
	0 0 1 0	0 1 0 0	0 0 1 0	0 0 0 0	9248	9A	154
	0 0 1 0	0 1 0 0	1 0 0 0	0 0 0 0	9344	9B	155
	0 0 1 0	0 1 0 0	0 0 0 0	0 0 0 0	9472	9C	156
	0 0 1 0	1 0 0 0	0 0 0 0	0 0 0 1	10241	9D	157
	0 0 1 0	1 0 0 0	0 0 0 0	0 0 1 0	10242	9E	158
	0 0 1 0	1 0 0 0	0 0 0 0	0 1 0 0	10244	9F	159
	0 0 1 0	1 0 0 0	0 0 0 0	1 0 0 0	10248	A0	160
	0 0 1 0	1 0 0 0	0 0 0 1	0 0 0 0	10256	A1	161
	0 0 1 0	1 0 0 0	0 0 1 0	0 0 0 0	10272	A2	162
	0 0 1 0	1 0 0 0	0 1 0 0	0 0 0 0	10304	A3	163
	0 0 1 0	1 0 0 0	0 0 0 0	0 0 0 0	10496	A4	164
	0 1 0 0	0 0 0 0	0 0 0 0	0 1 0 1	16389	A5	165
	0 1 0 0	0 0 0 0	0 0 0 0	1 0 0 1	16393	A6	166
	0 1 0 0	0 0 0 0	0 0 0 0	1 0 1 0	16394	A7	167
	0 1 0 0	0 0 0 0	0 0 0 1	0 0 1 0	16402	A8	168
	0 1 0 0	0 0 0 0	0 0 0 1	0 1 0 0	16404	A9	169

Table F.1 – 16-bits data to Symbols conversion



















	0 1 0 0	0 0 0 0	0 0 0 1	1 0 0 0	16408	AA	170
	0 1 0 0	0 0 0 0	0 0 1 0	0 0 0 1	16417	AB	171
	0 1 0 0	0 0 0 0	0 0 1 0	0 1 0 0	16420	AC	172
	0 1 0 0	0 0 0 0	0 0 1 0	1 0 0 0	16424	AD	173
	0 1 0 0	0 0 0 0	0 1 0 0	0 0 0 1	16449	AE	174
	0 1 0 0	0 0 0 0	0 1 0 0	0 0 1 0	16450	AF	175
	0 1 0 0	0 0 0 0	0 1 0 0	1 0 0 0	16456	B0	176
	0 1 0 0	0 0 0 0	0 1 0 1	0 0 0 0	16464	B1	177
	0 1 0 0	0 0 0 0	1 0 0 0	0 0 0 1	16513	B2	178
	0 1 0 0	0 0 0 0	1 0 0 0	0 0 1 0	16514	B3	179
	0 1 0 0	0 0 0 0	1 0 0 0	0 1 0 0	16516	B4	180
	0 1 0 0	0 0 0 0	1 0 0 1	0 0 0 0	16528	B5	181
	0 1 0 0	0 0 0 0	1 0 1 0	0 0 0 0	16544	B6	182
	0 1 0 0	0 0 0 1	0 0 0 0	0 0 0 1	16641	B7	183
	0 1 0 0	0 0 0 1	0 0 0 0	0 0 1 0	16642	B8	184
	0 1 0 0	0 0 0 1	0 0 0 0	0 1 0 0	16644	B9	185
	0 1 0 0	0 0 0 1	0 0 0 0	1 0 0 0	16648	BA	186
	0 1 0 0	0 0 0 1	0 0 1 0	0 0 0 0	16672	BB	187
	0 1 0 0	0 0 0 1	0 1 0 0	0 0 0 0	16704	BC	188

Table F.1 – 16-bits data to Symbols conversion



















	0 1 0 0	0 0 0 1	1 0 0 0	0 0 0 0	16768	BD	189
	0 1 0 0	0 0 1 0	0 0 0 0	0 0 0 1	16897	BE	190
	0 1 0 0	0 0 1 0	0 0 0 0	0 0 1 0	16898	BF	191
	0 1 0 0	0 0 1 0	0 0 0 0	0 1 0 0	16900	C0	192
	0 1 0 0	0 0 1 0	0 0 0 0	1 0 0 0	16904	C1	193
	0 1 0 0	0 0 1 0	0 0 0 1	0 0 0 0	16912	C2	194
	0 1 0 0	0 0 1 0	0 1 0 0	0 0 0 0	16960	C3	195
	0 1 0 0	0 0 1 0	1 0 0 0	0 0 0 0	17024	C4	196
	0 1 0 0	1 0 0 0	0 0 0 0	0 0 0 1	18433	C5	197
	0 1 0 0	1 0 0 0	0 0 0 0	0 0 1 0	18434	C6	198
	0 1 0 0	1 0 0 0	0 0 0 0	0 1 0 0	18436	C7	199
	0 1 0 0	1 0 0 0	0 0 0 0	1 0 0 0	18440	C8	200
	0 1 0 0	1 0 0 0	0 0 0 1	0 0 0 0	18448	C9	201
	0 1 0 0	1 0 0 0	0 0 1 0	0 0 0 0	18464	CA	202
	0 1 0 0	1 0 0 0	0 1 0 0	0 0 0 0	18496	CB	203
	0 1 0 0	1 0 0 1	0 0 0 0	0 0 0 0	18688	CC	204
	0 1 0 0	1 0 1 0	0 0 0 0	0 0 0 0	18944	CD	205
	0 1 0 1	0 0 0 0	0 0 0 0	0 0 0 1	20481	CE	206
	0 1 0 1	0 0 0 0	0 0 0 0	0 0 1 0	20482	CF	207

Table F.1 – 16-bits data to Symbols conversion



















	0 1 0 1	0 0 0 0	0 0 0 0	0 1 0 0	20484	D0	208
	0 1 0 1	0 0 0 0	0 0 0 0	1 0 0 0	20488	D1	209
	0 1 0 1	0 0 0 0	0 0 0 1	0 0 0 0	20496	D2	210
	0 1 0 1	0 0 0 0	0 0 1 0	0 0 0 0	20512	D3	211
	0 1 0 1	0 0 0 0	0 1 0 0	0 0 0 0	20544	D4	212
	0 1 0 1	0 0 0 0	1 0 0 0	0 0 0 0	20608	D5	213
	0 1 0 1	0 0 1 0	0 0 0 0	0 0 0 0	20992	D6	214
	0 1 0 1	1 0 0 0	0 0 0 0	0 0 0 0	22528	D7	215
	1 0 0 0	0 0 0 0	0 0 0 0	0 1 0 1	32773	D8	216
	1 0 0 0	0 0 0 0	0 0 0 0	1 0 0 1	32777	D9	217
	1 0 0 0	0 0 0 0	0 0 0 0	1 0 1 0	32778	DA	218
	1 0 0 0	0 0 0 0	0 0 0 1	0 0 1 0	32786	DB	219
	1 0 0 0	0 0 0 0	0 0 0 1	0 1 0 0	32788	DC	220
	1 0 0 0	0 0 0 0	0 0 0 1	1 0 0 0	32792	DD	221
	1 0 0 0	0 0 0 0	0 0 1 0	0 0 0 1	32801	DE	222
	1 0 0 0	0 0 0 0	0 0 1 0	0 1 0 0	32804	DF	223
	1 0 0 0	0 0 0 0	0 0 1 0	1 0 0 0	32808	E0	224
	1 0 0 0	0 0 0 0	0 1 0 0	0 0 0 1	32833	E1	225
	1 0 0 0	0 0 0 0	0 1 0 0	0 0 1 0	32834	E2	226

Table F.1 – 16-bits data to Symbols conversion





























	1 0 0 0	0 0 0 0	0 1 0 0	1 0 0 0	32840	E3	227
	1 0 0 0	0 0 0 0	0 1 0 1	0 0 0 0	32848	E4	228
	1 0 0 0	0 0 0 0	1 0 0 0	0 0 0 1	32897	E5	229
	1 0 0 0	0 0 0 0	1 0 0 0	0 0 1 0	32898	E6	230
	1 0 0 0	0 0 0 0	1 0 0 0	0 1 0 0	32900	E7	231
	1 0 0 0	0 0 0 0	1 0 0 1	0 0 0 0	32912	E8	232
	1 0 0 0	0 0 0 0	1 0 1 0	0 0 0 0	32928	E9	233
	1 0 0 0	0 0 0 1	0 0 0 0	0 0 0 1	33025	EA	234
	1 0 0 0	0 0 0 1	0 0 0 0	0 0 1 0	33026	EB	235
	1 0 0 0	0 0 0 1	0 0 0 0	0 1 0 0	33028	EC	236
	1 0 0 0	0 0 0 1	0 0 0 0	1 0 0 0	33032	ED	237
	1 0 0 0	0 0 0 1	0 0 1 0	0 0 0 0	33056	EE	238
	1 0 0 0	0 0 0 1	0 1 0 0	0 0 0 0	33088	EF	239
	1 0 0 0	0 0 0 1	1 0 0 0	0 0 0 0	33152	F0	240
	1 0 0 0	0 0 1 0	0 0 0 0	0 0 0 1	33281	F1	241
	1 0 0 0	0 0 1 0	0 0 0 0	0 0 1 0	33282	F2	242
	1 0 0 0	0 0 1 0	0 0 0 0	0 1 0 0	33284	F3	243
	1 0 0 0	0 0 1 0	0 0 0 0	1 0 0 0	33288	F4	244
	1 0 0 0	0 0 1 0	0 0 0 1	0 0 0 0	33296	F5	245

Table F.1 – 16-bits data to Symbols conversion

	1 0 0 0	0 0 1 0	0 1 0 0	0 0 0 0	33344	F6	246
	1 0 0 0	0 0 1 0	1 0 0 0	0 0 0 0	33408	F7	247
	1 0 0 0	0 1 0 0	0 0 0 0	0 0 0 1	33793	F8	248
	1 0 0 0	0 1 0 0	0 0 0 0	0 0 1 0	33794	F9	249
	1 0 0 0	0 1 0 0	0 0 0 0	0 1 0 0	33796	FA	250
	1 0 0 0	0 1 0 0	0 0 0 0	1 0 0 0	33800	FB	251
	1 0 0 0	0 1 0 0	0 0 0 1	0 0 0 0	33808	FC	252
	1 0 0 0	0 1 0 0	0 0 1 0	0 0 0 0	33824	FD	253
	1 0 0 0	0 1 0 0	1 0 0 0	0 0 0 0	33920	FE	254
	1 0 0 0	0 1 0 1	0 0 0 0	0 0 0 0	34048	FF	255



Annex G (normative)

Finalizing data

The Finalizing data shall be as shown in Table G.1.

The 41 finalizing bytes shall be stored at the beginning of a Data Page filled with additional bytes containing Zero data.

Table G.1 – Finalizing data

Item	Format/ Meaning	Bytes
Version of disk format	2 / HVD-ROM 100 GB	2
Version of Specific Disk Information	n / Version number x 100	2
Disk category	2 / HVD-ROM	2
Disk size	1 / 120 mm	2
Disk capacity	n / n Gbytes	2
Reserved	Set to Zero	14
Hologram read energy	n / n nanoJoules	2
Write strategy	1 / Sequential	1
Reserved	Set to Zero	2
Start track of user data	n / Track address number	2
Start Sector of user data	n / Sector address number	1
Start Channel bit of user data	n / Channel bit number	2
End track of user data	n / Track address number	2
End Sector of user data	n / Sector address number	1
End Channel bit of user data	n / Channel bit number	2
Amount of stored data	n / n Gbytes	2



Annex H (normative)

Tracking/Addressing and Data Reading Channels characteristics

H.1 Tracking/Addressing Channel characteristics

Analog signals and jitter shall be measured in the Tracking/Addressing Channel using the following circuit:

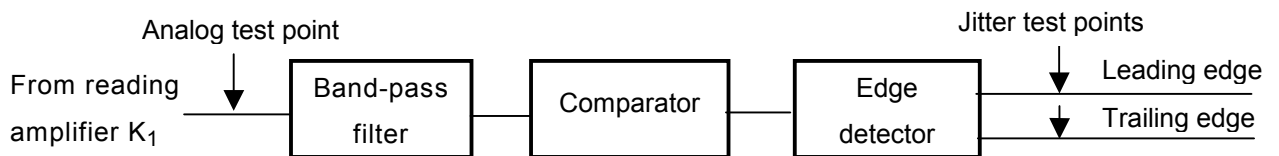

Figure H.1 – Addressing Channel block diagram

The band-pass filter shall be of the 2nd Order Bessel type with a bandwidth frequency of 20 Hz to 2 MHz.

H.2 Data Reading Channel characteristics

Data shall be detected in the Data Reading Channel by the following circuit:

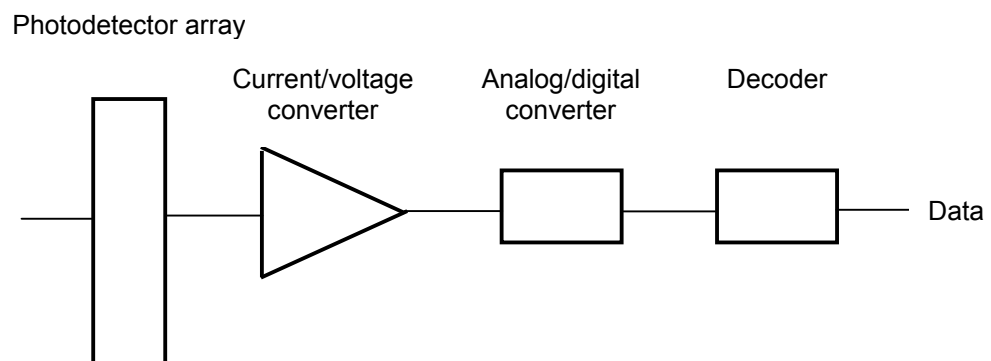
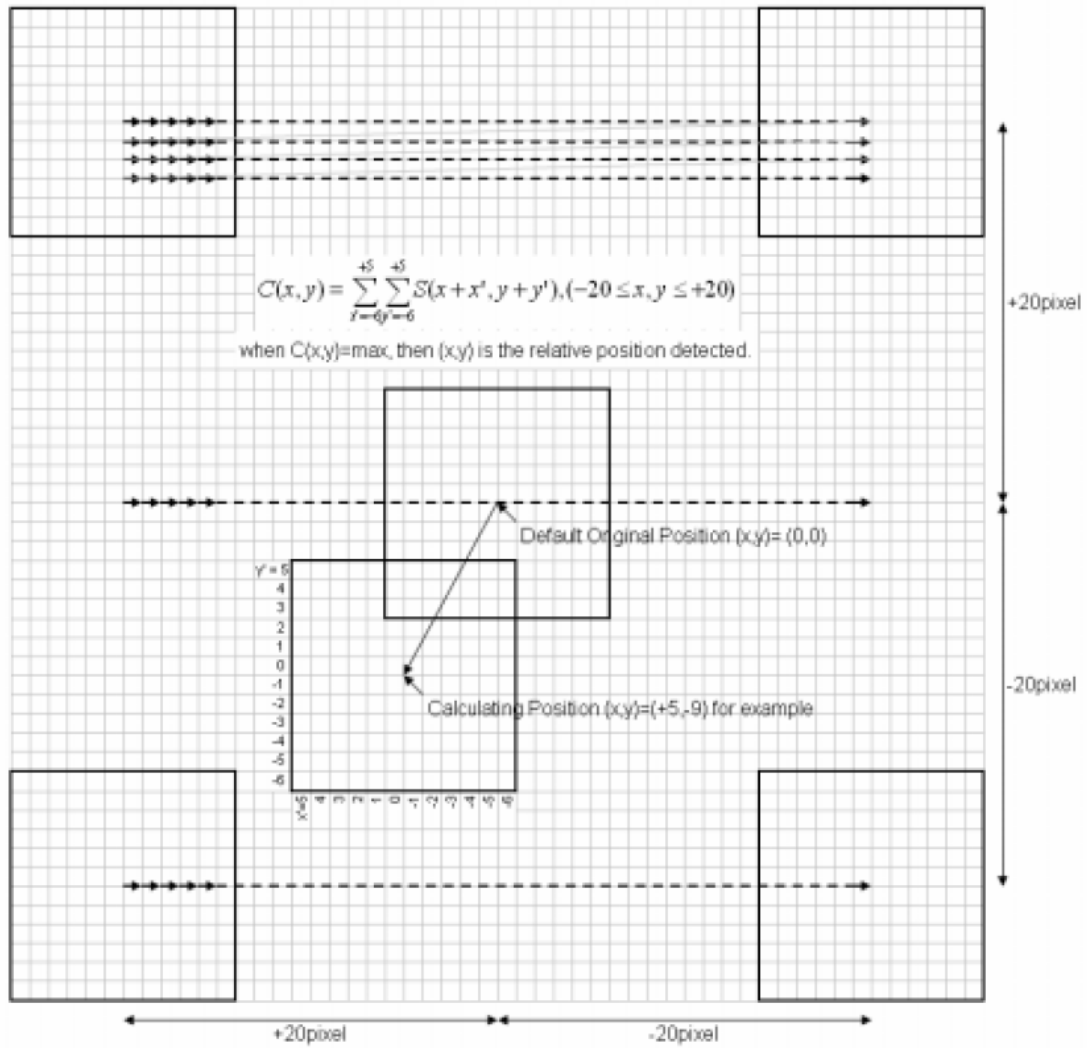

Figure H.2 – Data Reading Channel block diagram

H.2.1 Sync Marks detection

The Data Page Sync Mark shall be detected, as shown on Figure H.3a, by calculating the sum of the intensity of 12x12 (-6 to +6) pixels square for different positions of centre of this square in a range of 40x40 (-20 to +20) pixels around its supposed nominal position.

The position of the Data Page Sync Mark corresponds to the maximum of the detected sum.



$S(x+x', y+y')$ is the pixel signal intensity on the photodetector array.

Figure H.3a – Example of detection process of the Data Page Sync Mark

The Sub-Page Sync Mark shall be detected, as shown on Figure H.3b, by calculating the sum of the intensity of 12x12 (-6 to +6) pixels square for different positions of centre of this square in a range of 40x40 (-20 to +20) pixels around its supposed nominal position

The position of the Sync Mark corresponds to the maximum of the detected sum.

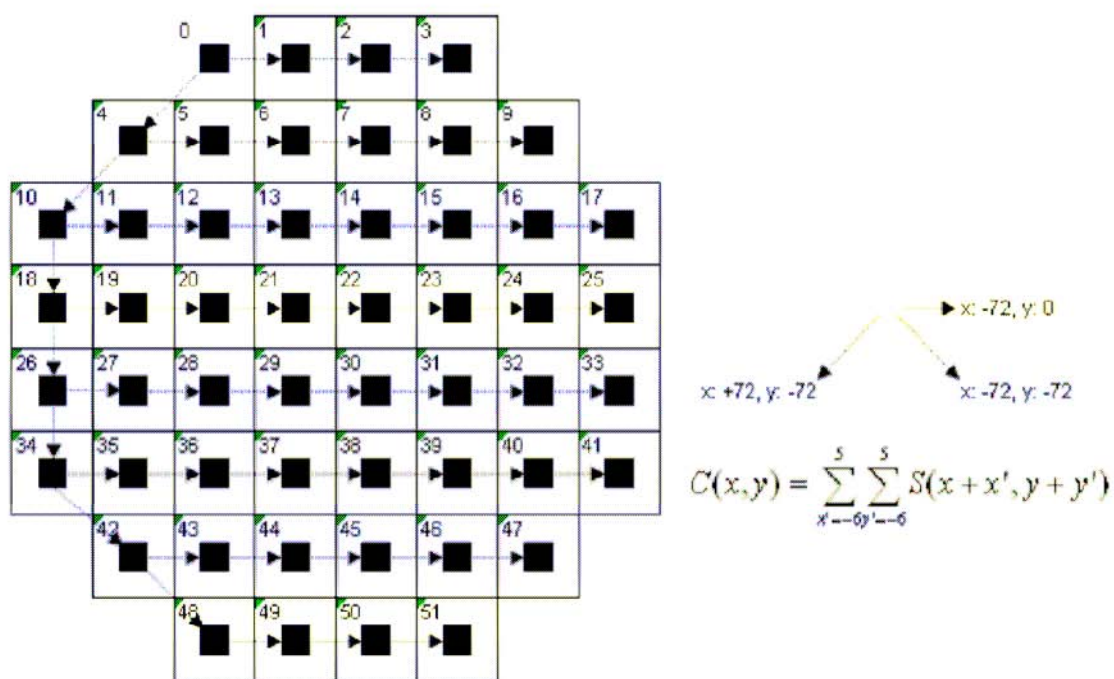

Figure H.3b – Example of detection process of the Sub-Page Sync Mark

H.2.2 Symbol decoding

The Symbol decoding shall be performed by a correlation process, as shown on Figure H.4.

The data content of the Symbol shall be the data content of the filter $F_i(x,y)$ giving the maximum of the multiplication signal C_i .

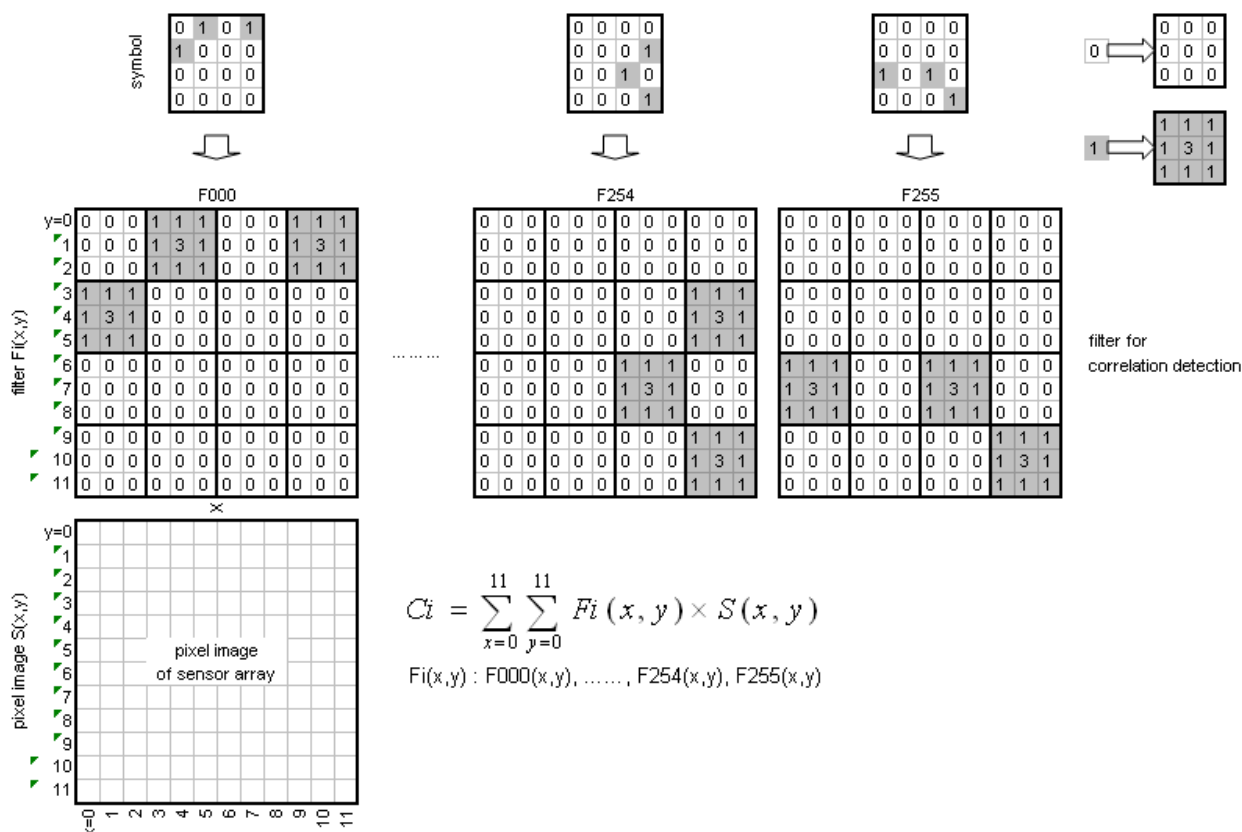

Figure H.4 – Symbol decoding

Annex I (normative)

Asymmetry measuring definition

The asymmetry of signals from mT and nT pits and lands shall be measured based on the following definitions. See Figure I.1.

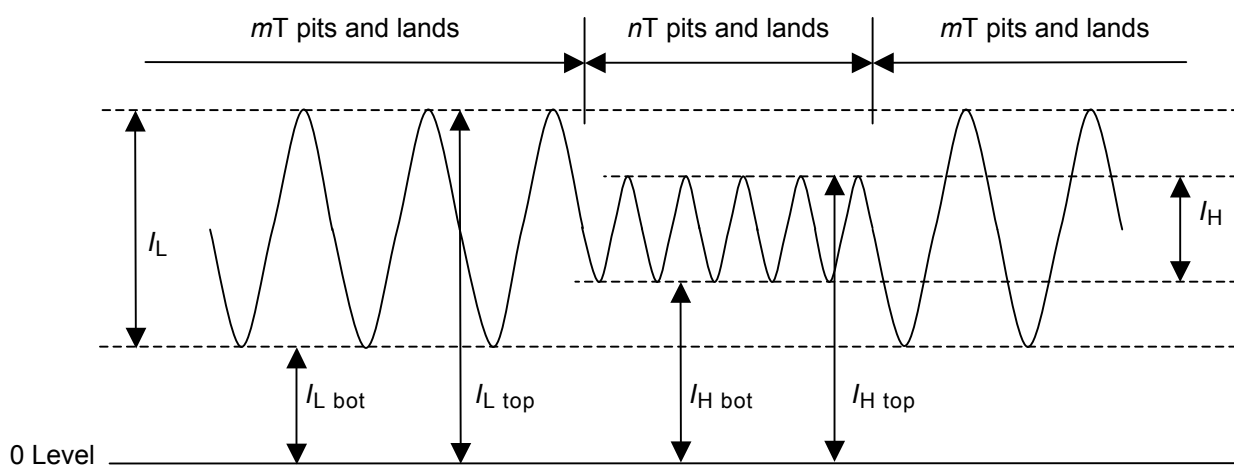

Figure I.1 – Signal from tracking/addressing data with mT and nT pits and lands

$$\text{Asymmetry (} mT\text{-}nT\text{)} = \frac{1/2 [(I_{L \text{ top}} + I_{L \text{ bot}}) - (I_{H \text{ top}} + I_{H \text{ bot}})]}{I_{L \text{ top}} - I_{L \text{ bot}}}$$

where

I_L and I_H are the peak-to-peak values of the Tracking/Addressing Channel signals for mT and nT pits and lands, read under the conditions specified in 16.2.

$I_{L \text{ top}}$, $I_{H \text{ top}}$, $I_{L \text{ bot}}$, $I_{H \text{ bot}}$ are the top and bottom levels of I_L and I_H .



Annex J **(informative)**

Office environment

J.1 Air cleanliness

Due to their construction and mode of operation, Holographic Disk Cartridges have considerable resistance to the effects of dust particles around and inside the disk drive. Consequently, it is not generally necessary to take special precautions to maintain a sufficiently low concentration of dust particles.

Operation in heavy concentrations of dust should be avoided, e.g. in a machine shop or on a building site.

Office environment implies an environment in which personnel may spend a full working day without protection and without suffering temporary or permanent discomfort.

J.2 Effects of operation

In the office environment (as well as other environments) it is possible for a holographic disk drive to degrade the quality of the stored pixels if the reading energy is applied to a track for a long period of time.

The media manufacturer's selection of the value for the maximum reading energy allowed in the User data Zones, as well as the drive manufacturer's reading energy management method, should reflect this possibility and be designed to minimize any risk to data integrity.



Annex K (informative)

Transportation

K.1 General

As transportation occurs under a wide range of temperature and humidity variations, for different periods, by many methods of transport and in all parts of the world it is not possible to specify conditions for transportation or for packaging.

The following gives recommendations.

K.2 Packaging

The form of packaging should be agreed between sender and recipient or, in the absence of such agreement, is the responsibility of the sender. It should take account of the following hazards.

K.2.1 Temperature and humidity

Insulation and wrapping should be designed to maintain the following conditions during transportation.

Temperature	5°C to 32°C
Atmospheric pressure	60 kPa to 106 kPa
Relative Humidity	5% to 80%
Absolute air humidity	25g/m ³ max.

No condensation on the disk.

K.2.2 Impact loads and vibration

Avoid mechanical loads that would distort the shape of the disk.

Avoid dropping the disk.

Disks should be packed in a rigid box containing adequate shock absorbent material.

The final box should have a clean interior and a construction that provides sealing to prevent the ingress of dirt and moisture.



Annex L (informative)

Track deviation measurement

The deviation of a track from its nominal location is measured in the same way as a drive sees a track, i.e. through a tracking servo. The strength of the Reference Servo used for the test is in general less than the strength of the same servo in a normal drive. The difference in strength is intended for margins in the drive. The deviation of the track is related to the tracking error between the track and the focus of the optical beam, remaining after the Reference Servo. The tracking error directly influences the performance of the drive, and is the best criterion for testing track deviations.

The specification of the axial and radial deviations can be described in the same terms. Therefore, this annex applies to both axial and radial track deviations.

L.1 Relation between requirements

The acceleration required by the motor of the tracking servo to make the focus of the optical beam follow the tracks on the disk (see 11.5.6 and 11.5.8) is a measure for the allowed deviations of the tracks. An additional measure is the allowed tracking error between the focus and the track (see 18.2.4). The relation between both is given in Figure L.1 where the maximum allowed amplitude of a sinusoidal track deviation is given as a function of the frequency of the deviation. It is assumed in the figure that there is only one sinusoidal deviation present at a time.

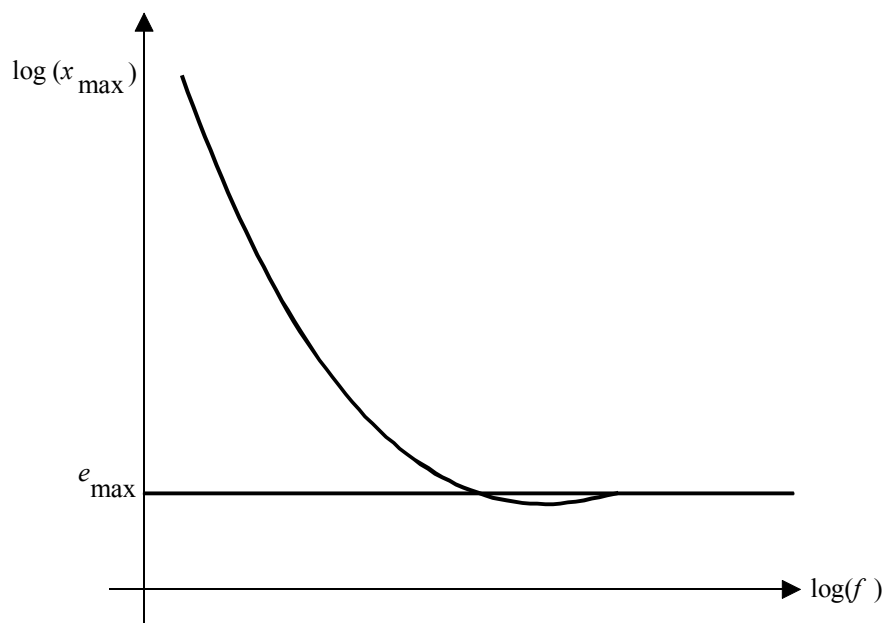

94-0145-A

Figure L.1 - Maximum allowed amplitude of a single, sinusoidal track deviation

At low frequencies the maximum allowed amplitude x_{\max} is given by

$$x_{\max} = a_{\max} / (2\pi f)^2, \quad (1)$$

where a_{\max} is the maximum acceleration of the servo motor.

At high frequencies the maximum allowed amplitude x_{\max} is given by

$$x_{\max} = e_{\max} \quad (2)$$

where e_{\max} is the maximum allowed tracking error. The connection between both frequency regions is given in L.3.

L.2 Reference Servo

The above restrictions of the track deviations are equal to the restriction of the track deviations for a Reference Servo. A Reference Servo has a well-defined transfer function, and reduces a single, sinusoidal track deviation with amplitude x_{\max} to a tracking error e_{\max} as in Figure L.1.

The open-loop transfer function of the Reference Servo shall be

$$H_s(i\omega) = \frac{1}{c} \times \left(\frac{\omega_0}{i\omega} \right)^2 \times \frac{1 + \frac{i\omega c}{\omega_0}}{1 + \frac{i\omega}{c\omega_0}} \quad (3)$$

where $i = \sqrt{-1}$, $\omega = 2\pi f$ and $\omega_0 = 2\pi f_0$, with f_0 the 0 dB frequency of the open-loop transfer function. The constant c gives the cross-over frequencies of the lead-lag network of the servo: the lead break frequency $f_1 = \frac{f_0}{c}$ and the lag break frequency $f_2 = f_0 \times c$. The reduction of a track deviation x to a tracking error e by the Reference Servo is given by

$$\frac{e}{x} = \frac{1}{1 + H_s} \quad (4)$$

If the 0 dB frequency is specified as

$$\omega_0 = \sqrt{\frac{a_{\max} c}{e_{\max}}} \quad (5)$$

then a low-frequency track deviation with an acceleration a_{\max} will be reduced to a tracking error e_{\max} , and a high frequency track deviation will not be reduced. The curve in Figure L.1 is given by

$$x_{\max} = e_{\max} |1 + H_s| \quad (6)$$

The maximum acceleration required from the motor of this Reference Servo is

$$a_{\max} (\text{motor}) = e_{\max} \omega^2 |1 + H_s| \quad (7)$$

At low frequencies $f > f_0 / c$ applies

$$a_{\max} (\text{motor}) = a_{\max} (\text{track}) = \frac{\omega_0^2 e_{\max}}{c} \quad (8)$$

Hence, it is permitted to use $a_{\max}(\text{motor})$ as specified for low frequencies in 10.5.6 and 10.5.8 for the calculation of ω_0 of a Reference Servo.

L.3 Requirement for track deviations

The track deviations shall be such that, when tracking with a Reference Servo on a disk rotating at the specified frequency, the tracking error shall not be larger than e_{\max} during more than 10 μs .

The open-loop transfer function of the Reference Servo for axial and radial tracking shall be given by equation (3) within an accuracy such that $|1 + H|$ does not differ by more than $\pm 20\%$ from its nominal value in a bandwidth from 20 Hz to 150 kHz. The constant c shall be 3. The 0 dB frequency

$\frac{\omega_0}{2\pi}$ shall be given by equation (5), where a_{\max} and e_{\max} for axial and radial tracking are specified in 9.4.1 and 18.2.4.

L.4 Measurement implementation

Three possible implementations for axial or radial measurement systems have been given below.

H_a is the open-loop transfer function of the actual tracking servo of the drive. H_s is the transfer function for the Reference Servo as given in equation (3). x and y are the position of the track and the focus of the optical beam. e_s is the tracking error after a Reference Servo, the signal of which has to be checked according to the previous paragraph.

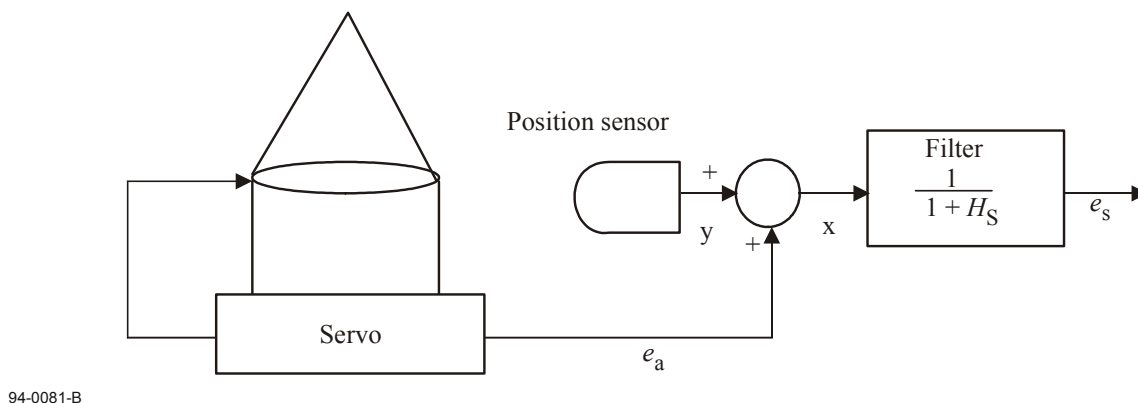

L.2 - Implementation of a Reference Servo by filtering the track position signal with the reduction characteristics of the Reference Servo

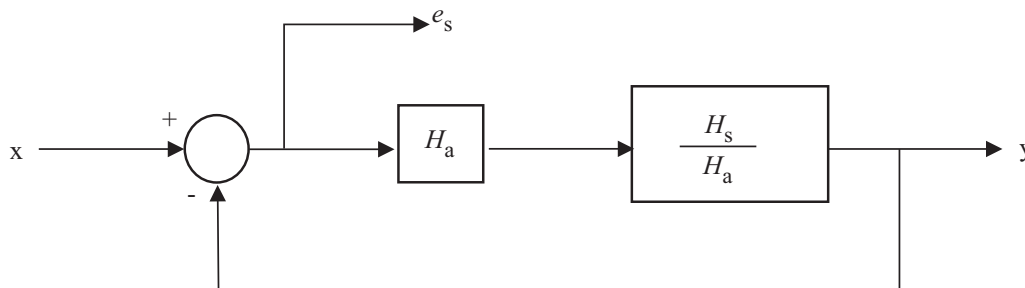
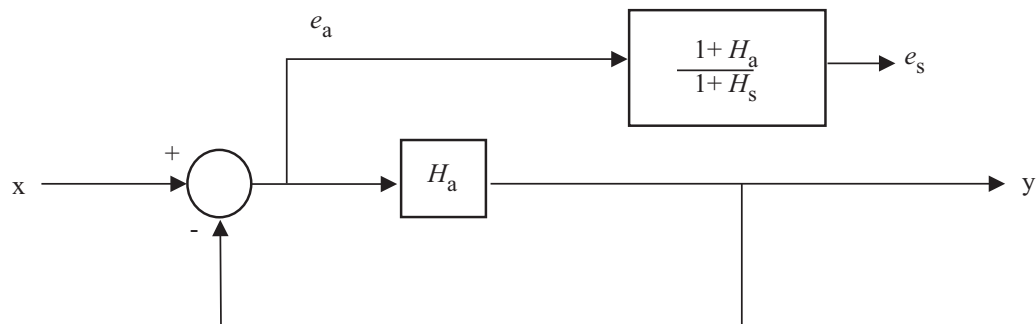

Figure L.3 - Implementation of a Reference Servo by changing the transfer function of the actual servo



94-0083-B

Figure L.4 - Implementation of a Reference Servo by changing the tracking error of the actual servo

The optimum implementation depends on the characteristics H_a and H_s . Good results for motors in leaf springs are often obtained by using separate circuits in a low and high frequency channel. The implementation of Figure L.2 is used in the low-frequency channel, while that of Figures L.3 or L.4 is used in the high-frequency channel. The signals from both channels are added with a reversed cross-over filter to get the required tracking error. In the low-frequency channel one can also use the current through the motor as a measure of the acceleration of the motor, provided the latter is free from hysteresis. The current must be corrected for the transfer function of the motor and then be converted to a tracking error with a filter with a transfer function $\frac{e}{a} = \frac{e}{x\omega^2}$ derived from equation (4).



