

Standard ECMA-391

1st Edition / December 2009

**Memory-Spot Interface
and Protocol (MSIP-1)**

Standard



is the registered trademark of Ecma International



COPYRIGHT PROTECTED DOCUMENT

Contents

Page

1	Scope	1
2	Conformance	1
3	Terms and definitions	1
4	Conventions and notations	3
4.1	Representation of numbers	3
5	Acronyms	3
6	General	5
7	Physical Layer	5
7.1	RF field.....	5
7.1.1	Frequency	5
7.1.2	Radiated Power.....	5
7.2	Passive communication mode	6
7.2.1	Received Power	6
7.3	Active communication mode	6
7.4	External RF power threshold value	6
8	RF Signal Interface	6
8.1	Bit duration	7
8.2	Active communication mode	7
8.2.1	Modulation	7
8.2.2	Bit representation and coding	8
8.2.3	Byte encoding.....	9
8.2.4	Data Whitening	9
8.3	Passive communication mode	9
8.3.1	Initiator to Target	9
8.3.2	Target to Initiator	11
9	Data Transaction and Frame Formats.....	12
9.1	Transaction between Initiator and Target(s).....	12
9.2	Frame format.....	13
9.2.1	Start of Frame (SOF)	14
9.2.2	Transport Data Fields.....	15
10	General Protocol flow	16
10.1	Protocol flow for Passive communication mode	16
10.2	Protocol flow for Active communication mode.....	19
11	Initialization and Anti-collision	21
11.1	General	21
11.2	RF Collision Avoidance	21
11.2.1	Initial RF Collision Avoidance.....	21
11.2.2	Response RF Collision Avoidance	22
11.3	Initialisation and device detection.....	22
11.4	Single Device Detection (SDD).....	26
11.5	Multiple device detection and isolation	27
12	Protocols	28
12.1	Reading the PROTOCOL value: Initiator command.....	28
12.2	Reading the PROTOCOL value: Target response.....	29
13	MSIP-1 Transport Protocol	29
13.1	Transport Data	29

13.1.1	Initiator to Target frame	29
13.1.2	Target to Initiator frame	30
13.2	Commands	30
13.3	Activation of the protocol	31
13.3.1	Attribute Request and Response Commands	31
13.3.2	Wakeup Request and Response Commands	37
13.3.3	Parameter Selection Request and Response Commands	39
13.4	Data Exchange Protocol	42
13.4.1	Data Exchange Protocol Request and Response	42
13.4.2	Response timeout extension	46
13.4.3	Attention – Target present	46
13.4.4	Protocol operation	46
13.4.5	Multi Activation	47
13.4.6	More information (Chaining).....	47
13.5	Deactivation of the protocol	48
13.5.1	Deselect Request and Response command	48
13.5.2	Release Request and Response commands	49
14	Direct Addressing Protocol	51
14.1	Read (CMD3=0x00)	51
14.1.1	Initiator command.....	51
14.1.2	Target response.....	51
14.2	Write (CMD3=0x01)	52
14.2.1	Initiator command.....	52
14.2.2	Target response.....	52
14.3	WriteSync (CMD3=0x02).....	52
14.3.1	Initiator command.....	53
14.3.2	Target response.....	54
14.4	PageErase (CMD3=0x03).....	54
14.4.1	Initiator command.....	54
14.4.2	Target response.....	54
14.5	MassErase (CMD3=0x08)	55
14.5.1	Initiator command.....	55
14.5.2	Target response.....	55
14.6	Authenticate (CMD3=0x04)	55
14.6.1	Initiator command.....	56
14.6.2	Target response.....	56
14.7	ReportID (CMD3=0xFE)	56
14.7.1	Initiator Command	57
14.7.2	Target Response.....	57
14.8	ResetID (CMD3=0xFF)	57
14.8.1	Initiator Command	58
14.8.2	Target Response.....	58
14.9	Acknowledgement – ACK (CMD3 = 0x06)	59
14.10	Negative Acknowledgement – NAK (CMD3 = 0x15)	59
14.11	Device Management	59
14.11.1	Attribute Discovery.....	59
14.11.2	Parameter Selection	61
15	Target Fixed Internal Map	61
15.1	Map.....	61
15.2	Physical Device Identifier (PDID)	62
15.3	Device Common Control Parameters (DCCP)	62
15.4	Target Common Control Parameters (TCCP)	63
15.4.1	Universal Target Header Identity (UTHID) – Location 0x00000018.....	63
15.4.2	Universal Target Header Version (VER) – Location 0x00000019	63
15.4.3	User Start Page (usrStrtPg) – Location 0x0000001A	63
15.4.4	Row Size (RowSz) – Location 0x0000001B	63
15.4.5	Page Size (PgSz) – Location 0x0000001C	63
15.4.6	size (Sz) – Location 0x0000001D.....	63

15.4.7	ChkSum1– Location 0x0000001E	64
15.4.8	PDSTRT– Location 0x00000020	64
15.4.9	PDDATA– Location 0x00000021	64
15.4.10	PDRX– Location 0x00000022	64
15.4.11	PDEND– Location 0x00000023	64
15.4.12	PDPERASE– Location 0x00000024.....	64
15.4.13	PDMERASE– Location 0x00000026	64
15.4.14	MEM_DATA– Location 0x00000028	64
15.4.15	AUTH_PAD– Location 0x00000029.....	65
15.4.16	ChkSum2– Location 0x0000002B	65
15.4.17	ID Parameter– Location 0x00000100	65
15.4.18	PSL Parameter– Location 0x00000102.....	65
15.5	Write only Memory (WOM).....	65
Annex A (normative) CRC Calculation		67
Annex B (informative) Authentication.....		69
Annex C (normative) Reference Antennas.....		71
C.1	Reference Antenna #1	71
C.1.1	Design Information	71
C.1.2	Antenna Validation	72
C.1.3	Use of Reference Antenna to measure radiated power and received power	73
C.2	Reference Antenna #2.....	73
C.2.1	Design Information	73
C.2.2	Antenna Validation	76
C.2.3	Use of Reference Antenna to measure radiated power and received power	76
C.3	Reference Antenna #3.....	76
C.3.1	Design Information	76
C.3.2	Antenna Validation	77
C.3.3	Use of Reference Antenna to measure radiated power and received power	78

Introduction

This Standard specifies the interface and protocol for simple wireless communication at 10 Mbps or higher between close coupled devices.

The Memory Spot Interface and Protocol (MSIP-1) Standard allows, but does not specify, applications in network products and consumer equipment.

This Ecma Standard has been adopted by the General Assembly of December 2009.

DISCLAIMER

This document and possible translations of it may be copied and furnished to others, and derivative works that comment on or otherwise explain it or assist in its implementation may be prepared, copied, published, and distributed, in whole or in part, without restriction of any kind, provided that the above copyright notice and this section are included on all such copies and derivative works. However, this document itself may not be modified in any way, including by removing the copyright notice or references to Ecma International, except as needed for the purpose of developing any document or deliverable produced by Ecma International (in which case the rules applied to copyrights must be followed) or as required to translate it into languages other than English.

The limited permissions granted above are perpetual and will not be revoked by Ecma International or its successors or assigns.

This document and the information contained herein is provided on an "AS IS" basis and ECMA INTERNATIONAL DISCLAIMS ALL WARRANTIES, EXPRESS OR IMPLIED, INCLUDING BUT NOT LIMITED TO ANY WARRANTY THAT THE USE OF THE INFORMATION HEREIN WILL NOT INFRINGE ANY OWNERSHIP RIGHTS OR ANY IMPLIED WARRANTIES OF MERCHANTABILITY OR FITNESS FOR A PARTICULAR PURPOSE.

Memory-Spot Interface and Protocol (MSIP-1)

1 Scope

This Ecma Standard specifies modulation schemes, codings, data rates, and frame formats of the RF interface, as well as initialization schemes and conditions required for data collision control during initialization. Furthermore, this Ecma Standard specifies a transport protocol including protocol activation and data exchange methods.

2 Conformance

MSIP-1 devices support both the Initiator and Target roles of operation, the Active and Passive communication modes of operation and protocols, as specified in Table 1.

Table 1 — Conformant Device Matrix

Role	Active communication mode (see 7.3, 8.2)	Passive communication mode (see 7.2, 8.3)	Direct Addressing Protocol (see 14)	MSIP-1 Transport Protocol (see 13)
Initiator	Shall be supported	Shall be supported	Shall be supported	Shall be supported
Target	Shall be supported	Shall be supported	At least one protocol shall be supported and indicated by the PROTOCOL byte (see 14.11.1.1)	

3 Terms and definitions

For the purposes of this document, the following terms and definitions apply.

3.1

Active communication mode

Mode in which both the Initiator and the Target use their own RF field to enable the communication

3.2

Collision

Transmission by two or more Targets or Initiators during the same Time Period, such that the Initiator or the Target is unable to distinguish from which Target the data originated

3.3

Frame

Sequence of data bits and optional error detection bits, with frame delimiters at start and end

3.4

Initiator

Generator of the RF field and starter of the MSIP-1 communication

3.5
Load modulation
Process of amplitude and/or phase modulating a radio frequency field by varying the properties of a resonant circuit placed within the radio frequency field

3.6
lsb first
least significant bit first, indicating a serial data transmission system that sends lsb before all other bits

3.7
LSB first
Least Significant Byte first, indicating a serial data transmission system that sends LSB before all other bytes

3.8
Manchester coding
Method of bit coding whereby a logic level during a bit duration is represented by a sequence of two defined physical states of a communication medium

NOTE The order of the physical states within the sequence defines the logical state. The coding system which divides into half at the changing point in the middle point of bit self-sustaining time, and makes the direction of the changes correspond to two logic value.

3.9
msb first
most significant bit indicating a serial data transmission system that sends the msb before all other bits

3.10
MSIP-1 device
General term for either an Initiator or a Target communicating in the Active or the Passive communication mode

3.11
Passive communication mode
When the Initiator is generating the RF field and the Target responds to an Initiator command in a load modulation scheme

3.12
RF Collision Avoidance (RFCA)
Method to detect the presence of a RF field based on the carrier frequency and method to detect and resolve collisions on protocol level

3.13
Single Device Detection (SDD)
An algorithm used by the Initiator to detect one out of several Targets in its RF field

3.14
Target
Responds to Initiator command either using load modulation scheme (RF field generated by Initiator) or using modulation of self generated RF field

3.15
Time Period
Slots used for RF Collision Avoidance

4 Conventions and notations

4.1 Representation of numbers

The following conventions and notations apply in this document unless otherwise stated.

- Letters and digits in parentheses represent numbers in hexadecimal notation, in addition to hexadecimal numbers that are prefixed by 0x.
- The setting of bits is denoted by ZERO or ONE.
- Numbers in binary notation and bit patterns are represented by a sequence of digits 0 and 1 shown with the most significant bit to the left. Within such strings, X may be used to indicate that the setting of a bit is not specified within the string.
- || between arguments indicates concatenation of the arguments.

5 Acronyms

ALL_REQ	Wake up ALL Request
AM	Amplitude Modulation
ATR	Attribute Request and Attribute Response
ATR_REQ	Attribute Request
ATR_RES	Attribute Response
BRI	Receiving bit duration supported by Initiator
BRT	Receiving bit duration supported by Target
BSi	Sending bit duration supported by Initiator
BSt	Sending bit duration supported by Target
CHAN	Channel Number Field
CMD	Command
CRC	Cyclic Redundancy Check
CRCH	Header CRC
CRCP	Payload CRC
CRCT	Target Transport Payload CRC
DEP	Data Exchange Protocol Request and Data Exchange Protocol Response
DEP_REQ	Data Exchange Protocol Request
DEP_RES	Data Exchange Protocol Response
DIDi	Initiator Device ID
DIDt	Target Device ID
DRi	Data rate Received by initiator
DRt	Data rate Received by initiator
DSi	Data rate Send by initiator
DSL	Deselect Request and Deselect Response
DSL_REQ	Deselect Request
DSL_RES	Deselect Response

DSt	Data rate Send by Target
DUT	Device Under Test
fc	Frequency of operating field (carrier frequency)
Gi	Optional information field for Initiator
Gt	Optional information field for Target
ID	Identification number
lsb	least significant bit
LSB	Least Significant Byte
MI	Multiple Information link for Data Exchange Protocol
msb	most significant bit
MSB	Most Significant Byte
NFCID3	Random ID for transport protocol activation
nfcid3n	Byte number n of the Random Identifier NFCID3
PA	Preamble
PDID	Physical Device Identifier
PDU	protocol data unit
PFB	Control information for transaction
PNI	Packet Number Information
PPi	Protocol Parameters used by Initiator
PPt	Protocol Parameters used by Target
PSL	Parameter Selection Request and Parameter Selection Response
PSL_REQ	Parameter Selection Request
PSL_RES	Parameter Selection Response
RF	Radio Frequency
RFCA	RF Collision Avoidance
RFU	Reserved for Future Use
RLS	Release Request and Release Response
RLS_REQ	Release Request
RLS_RES	Release Response
RWT	Response Waiting Time
SOCK	Socket ID Field
SOF	Start of Frame
SYNC	Synchronisation pattern
TO	Timeout value
WUP	Wakeup Request and Wakeup Response
WUP_REQ	Wakeup Request
WUP_RES	Wakeup Response
WT	Waiting Time

6 General

This Standard defines both the Active and the Passive communication modes as follows:

In the Active communication mode, both the Initiator and the Target use their own RF field to enable communication. The Initiator starts the MSIP-1 communication. The Target responds to an Initiator command in the Active communication mode using self-generated modulation of a self-generated RF field.

In the Passive communication mode, the Initiator generates the RF field and starts the communication. The Target responds to an Initiator command in the Passive communication mode using a load modulation scheme.

The communication over the RF interface in the Active and the Passive communication mode includes modulation schemes, data rate and bit coding. In addition it includes the start of communication, the end of communication, the bit and byte representation, the framing and error detection, collision avoidance, the protocol and parameter selection and the data exchange and deactivation of the MSIP-1 devices. A communication between Initiator and Target is started by device initialisation and terminated by device deactivation.

All MSIP-1 devices have a communication capability of 10 Mbps.

The communication mode (Active or Passive) is not to be changed between activation and deactivation of the Target.

7 Physical Layer

7.1 RF field

7.1.1 Frequency

The carrier frequency of the RF field (f_c) shall be $2\,442\text{ MHz} \pm 1\text{ MHz}$.

7.1.2 Radiated Power

An MSIP-1 Device belongs to at least one of the Device Classes specified in Table 2.

An Initiator's radiated power shall be measured using a standard antenna configuration as specified in Annex C. For each Device Class the Initiator's radiated power shall conform to the values given in Table 2 at the measurement ranges given in Table 2.

Table 2 — Device Classes – Radiated Power

Device Class	Distance between measurement Antenna and DUT (mm)	Power (P_{mid}) measured at reference antenna (dBm)	NOTE
1	$5,0 \pm 0,1$	$7,5 \pm 0,75$	1
2	$10,0 \pm 0,5$	$13,5 \pm 0,75$	1
3	$100,0 \pm 0,5$	$7,5 \pm 0,75$	1

NOTE 1 Two MSIP-1 Devices will interoperate if they belong to the same device class.

Device Classes have been chosen to support range of possible device implementations designed for different applications. These Device Classes may typically support maximum operating ranges operating ranges and antenna sizes as listed in Table 3.

Table 3 — Device Classes – typical operating distance and antenna area

Device Class	Typical Maximum Operating Distance (mm)	Typical Antenna Area (mm ²)
1	1	10
2	10	100
3	100	1000

7.2 Passive communication mode

An Initiator shall radiate power to energise the Target as specified in 7.1.2.

7.2.1 Received Power

A Target shall operate continuously when radiated from a reference antenna configuration as specified in Annex C with an applied power level and operating distance as specified in Table 4.

Table 4 — Device Classes – Received Power

Device Class	Distance between reference antenna and DUT (mm)	Power applied at reference antenna (dBm)
1	1,0 ± 0,1	18,5 ± 0,1
2	10,0 ± 0,5	18,5 ± 0,1
3	100,0 ± 0,5	18,5 ± 0,1

7.3 Active communication mode

An Initiator and a Target shall alternately radiate power of a level as specified in 7.1.2.

When receiving data, the Initiator and Target shall operate at a received power level as specified in 7.2.1.

7.4 External RF power threshold value

MSIP-1 devices shall detect external RF power levels at 2 442 MHz with a value higher than $P_{\text{Threshold}}$, as specified in Table 5, while performing external RF power detection.

Table 5 — $P_{\text{Threshold}}$

Device Class	Distance between reference antenna and DUT (mm)	Power $P_{\text{Threshold}}$ applied at reference antenna (dBm)
1	1,0 ± 0,1	1,0 ± 0,1
2	10,0 ± 0,5	1,0 ± 0,1
3	100,0 ± 0,5	1,0 ± 0,1

8 RF Signal Interface

This Clause specifies the signal interface for a data rate of 10 Mbps.

8.1 Bit duration

For Active communication mode the bit duration, T_{bit} , (see Figure 1) shall be $100 \text{ ns} \pm 1 \text{ ns}$ for communication both from the Initiator to the Target and from the Target to the Initiator.

For Passive communication mode the bit duration T_{bit} , shall be $100 \text{ ns} \pm 1 \text{ ns}$ for communication from the Initiator to Target and shall be $100 \text{ ns} \pm 15 \text{ ns}$ for communication from Target to the Initiator.

8.2 Active communication mode

The specification both from the Initiator to the Target and from the Target to the Initiator shall be identical.

8.2.1 Modulation

8.2.1.1 Amplitude Modulation

Data transmission between the Initiator and the Target shall use Amplitude Modulation compliant with the limits shown in Figure 1 and Table 6.

NOTE A compliant signal does not enter the hatched area in Figure 1.

Table 6 — AM parameters

P_{max}	$P_{mid} + 1,6 \text{ dB} \pm 0,4 \text{ dB}$
P_{mid}	Power level specified in Table 2.
P_{min}	$P_{mid} - 2 \text{ dB} \pm 0,6 \text{ dB}$
$T_{transition}$	<50 ns

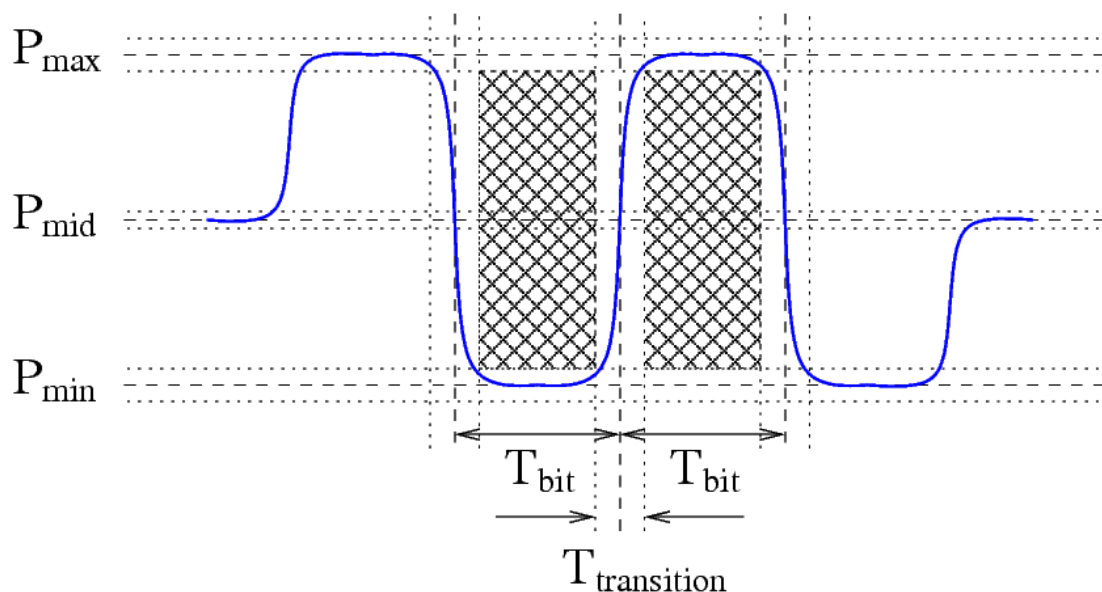

Figure 1 — AM power and time limits

The filtering applied to the bit stream used for Amplitude Modulation shall be such that when combined with the Spectrum Spreading Modulation (see NOTE below) the necessary national or international regulations for spectral emissions are met.

The profile of a transmission shall be as follows, with reference to Figure 2:

- A. The power is smoothly ramped to the mean level, to eliminate the spectral growth caused by a sudden switch-on. Period A shall be less than 5 μ s.
- B. The power shall be maintained at the mean level for at least 20 μ s to allow the Target to power up and initialize itself.
- C. Data shall be transmitted.
- D. The power is smoothly ramped down to zero. Period D shall be less than 5 μ s.

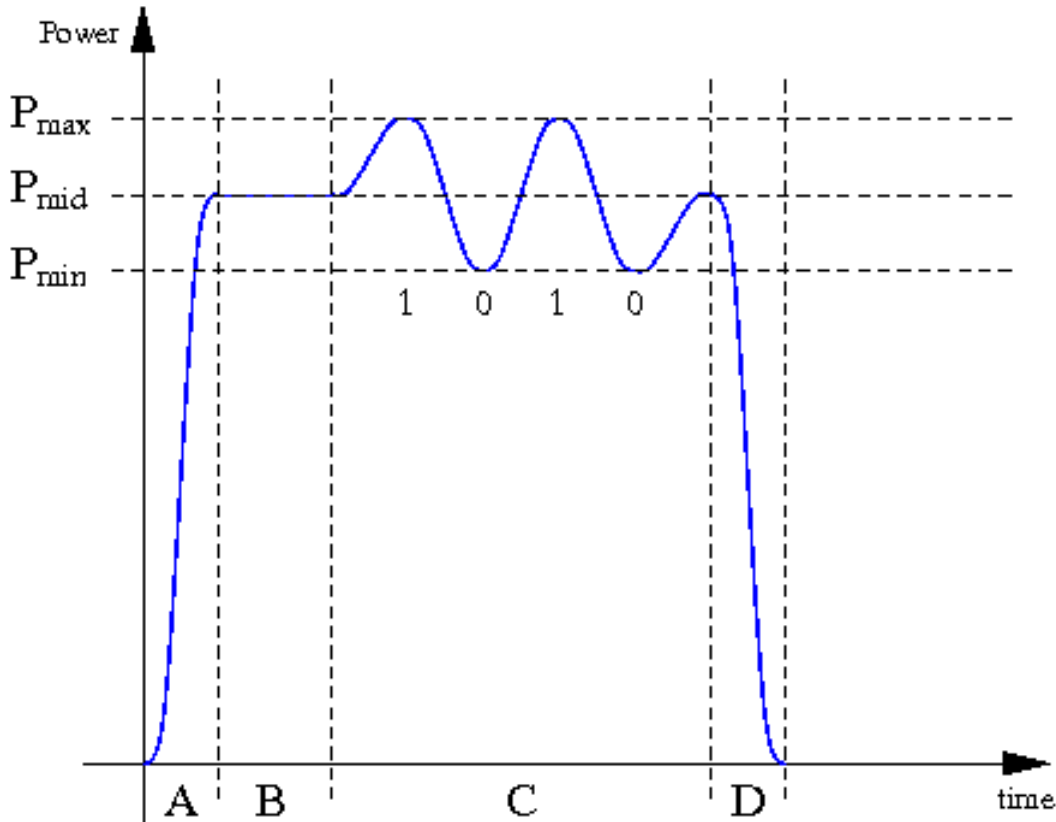

Figure 2 — Active communication mode transmission profile

NOTE In addition to the amplitude modulation used for data transmission, there may also be modulation of the carrier frequency in order to reduce its power spectral density. This is applied throughout regions B and C in Figure 2 and can be done in any manner that complies with the necessary national and international regulations for spectral emissions. For example, for most countries within the Committee on European Postal Regulations (CEPT) there shall be a peak power density of 10 mW/MHz and a maximum average transmitted power of 100 mW (both values measured as e.i.r.p.).¹

8.2.2 Bit representation and coding

Logic “ZERO”: Shall be represented by a low carrier amplitude for one bit duration.

Logic “ONE”: Shall be represented by a high carrier amplitude for one bit duration.

¹ ERC Recommendation 70-03 (Tromsø 1997 and subsequent amendments), Version 9, February 2007, Annex 3.

8.2.3 Byte encoding

The byte encoding shall be most significant bit (msb) first.

8.2.4 Data Whitening

Data whitening shall be performed on the MSIP-1 Transport Data Fields only.

The whitening word is generated using a 7 bit LFSR with the polynomial $f(D) = D^7 + D^5 + 1$ and subsequently EXORed with the MSIP-1 Transport Data Fields data. Before each transmission, the shift register is initialised with logical ONES. After initialisation, the MSIP-1 Transport Data Field is scrambled. The first bit of the “Data in” sequence is the msb of the MSIP-1 Transport Data Fields.

The received data is de-scrambled using the same whitening word.

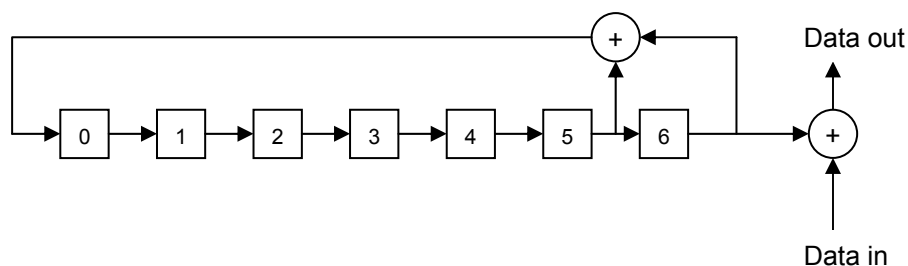

Figure 3 — Data whitening LFSR for Initiator and Target

8.3 Passive communication mode

8.3.1 Initiator to Target

8.3.1.1 Modulation

Transmission between the Initiator and the Target uses Amplitude Modulation identical to that described in Amplitude Modulation, 8.2.1.1, but with a different transmission profile.

The profile of a transmission shall be as follows, with reference to Figure 4:

- A. The power is smoothly ramped to the mean level, to eliminate the spectral growth caused by a sudden switch-on. Period A shall be less than 5 μ s.
- B. The power shall be maintained at the mean level for at least 20 μ s to allow the Target to power up and initialize itself.
- C. Data is transmitted.
- D. The power is maintained at the mean level while the Target responds.
- E. The power is smoothly ramped down to zero. Period E shall be less than 5 μ s.

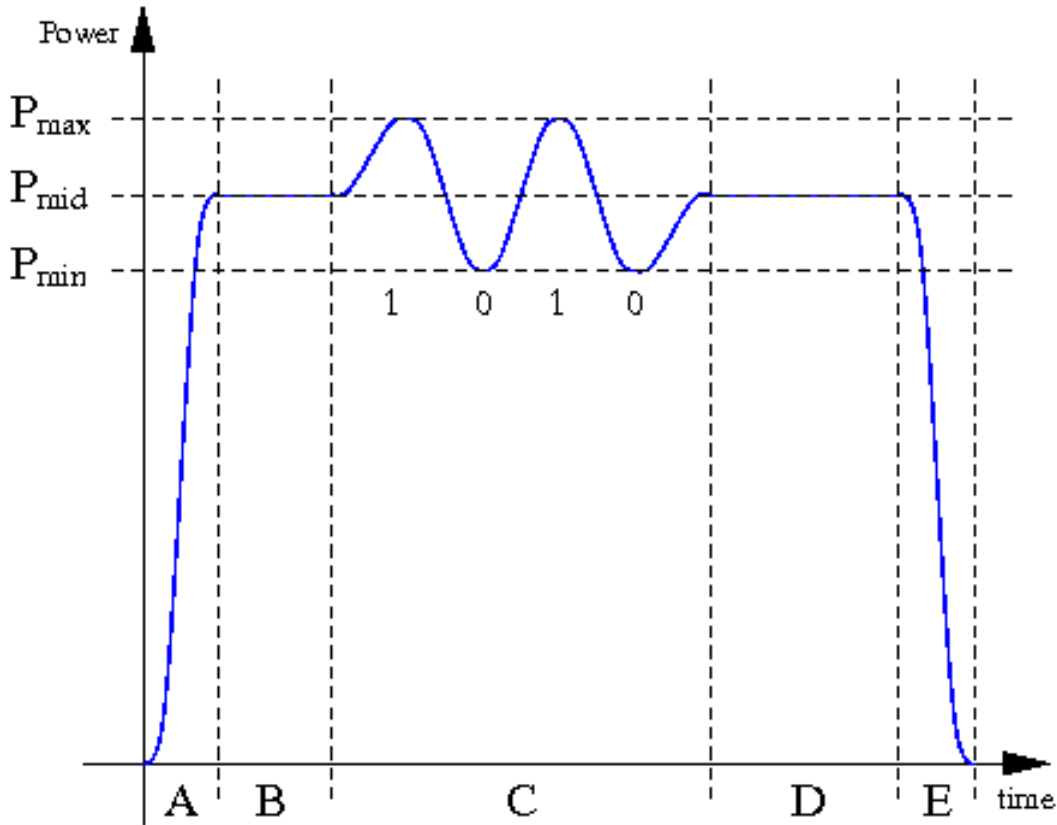

Figure 4 — Passive communication mode transmission profile

NOTE In addition to the amplitude modulation used for data transmission, there may also be modulation of the carrier in order to reduce its power spectral density. This is applied throughout regions B and C and D in Figure 4 and can be done in any manner that complies with the necessary national and international regulations for spectral emissions. For example, for most countries within the Committee on European Postal Regulations (CEPT) there shall be a peak power density of 10 mW/MHz and a maximum average transmitted power of 100 mW (both values measured as e.i.r.p.).²

8.3.1.2 Bit representation and coding

Manchester bit encoding shall be employed.

For each input bit the Manchester coder produces an output word of two symbols, according to either Table 7 or

Table 8 below; the use of either is acceptable. The duration of each output symbol is the same as the bit duration specified in 0. Since two symbols are derived from one input data bit, the input data bit duration is twice as long as that specified in 0.

Polarity of the encoded data may be detected in the Target from the SYNC field.

Figure 5 below shows an example of the Manchester encoding of a short input data stream.

² ERC Recommendation 70-03 (Tromsø 1997 and subsequent amendments), Version 9, February 2007, Annex 3.

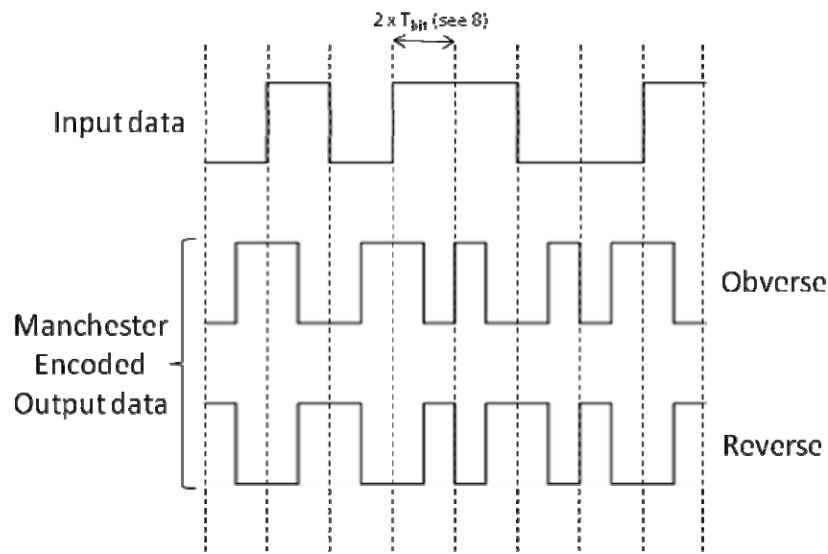

Figure 5 — Example - Manchester encoding

Table 7 — Manchester Encoding – Obverse

Obverse Coding		
Input bit	Output symbols	
0	0	1
1	1	0

Table 8 — Manchester Encoding - Reverse

Reverse Coding		
Input bit	Output symbols	
0	1	0
1	0	1

8.3.1.3 Byte encoding

The byte encoding shall be most significant bit (msb) first.

8.3.2 Target to Initiator

8.3.2.1 Modulation

The power reflected by the Target for at least one of the modulation states, shall be greater than 5% of the power received by the Target.

The magnitude of the vector difference of the load modulation states, shall be greater than 4% and less than 15% of the mean magnitude of the reflected signal, the mean magnitude being the average magnitude of the load modulation signal of the two modulation states.

Figure 6 illustrates the requirements described above.

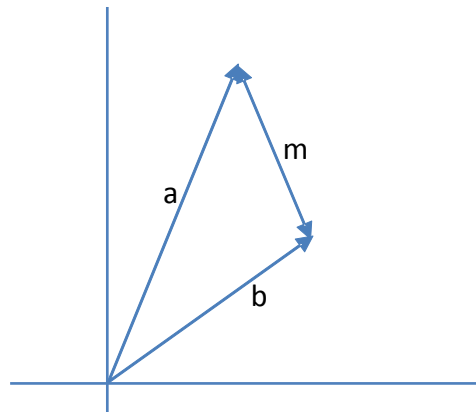

a = power reflection coefficient of passive target when sending data = ZERO
 b = power reflection coefficient of passive target when sending data = ONE

$|a|$ or $|b| > 0,05$

m = magnitude of vector difference of reflected states such that:
 $0,04 \times (|a| + |b|) / 2 < m < 0,15 \times (|a| + |b|) / 2$

Figure 6 — Passive Target Load Modulation

8.3.2.2 Bit representation and coding

Logic ZERO is represented by one of the two load modulation states, logic ONE is represented by the other load modulation state.

The logic sense shall be determined by the use of the SYNC field in the Target Frame.

8.3.2.3 Byte encoding

The byte encoding shall be most significant bit (msb) first.

8.3.2.4 Data Whitening

Data whitening shall be performed on the MSIP-1 Transport Data Fields only.

The scrambling method as used for Active communication mode transmissions shall be used as defined in 8.2.4.

9 Data Transaction and Frame Formats

9.1 Transaction between Initiator and Target(s)

A transaction shall consist of the transmission of an Initiator frame and the reception of a Target Frame.

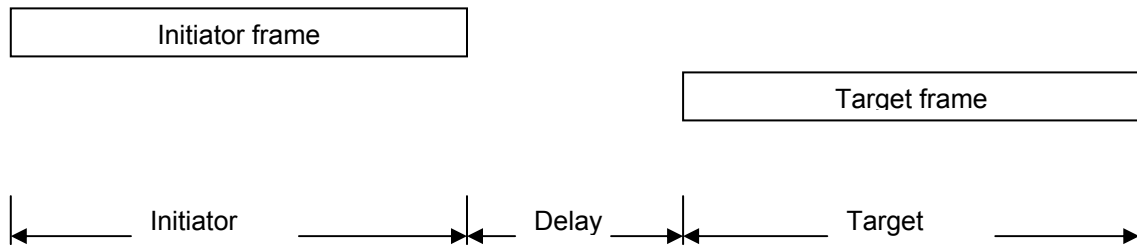

Figure 7 — Successful transaction

For the Direct Addressing Protocol (see Clause 14) the Target shall respond to an Initiator Frame not before 4 μ s and no later than 50 μ s after the completion of the final bit of the Initiator Frame, unless the Direct Addressing Protocol command explicitly permits a longer delay.

If the Initiator does not receive a response from the Target it shall timeout after 50 μ s. It may then retry the command.

For the MSIP-1 Transport Protocol (see Clause 11) the Target shall respond to an Initiator Frame not before 4 μ s and no later than 10 ms after the completion of the final bit of the Initiator Frame.

NOTE In MSIP-1 Transport Protocol, the delay for a response from the Target may be adjusted by the Timeout byte in an Attribute Response (see 13.3.1.2) from the Target.

If the Target detects a corrupted frame before the end of the transmission by the Initiator as in Figure 8, it may immediately send a response incorporating a negative acknowledgment.

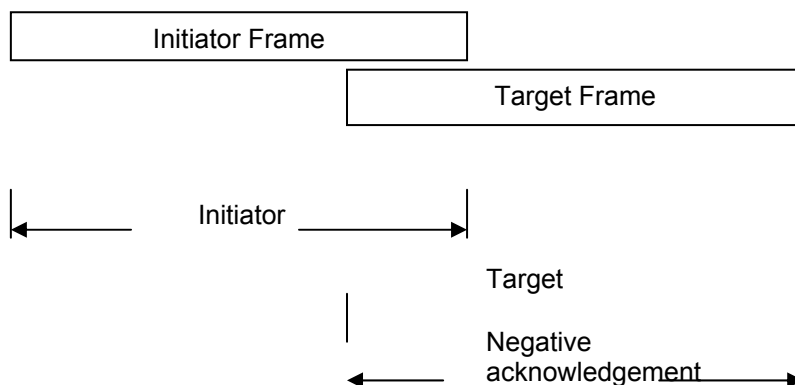

Figure 8 — Unsuccessful transaction

9.2 Frame format

Initiator Frames shall conform to the format shown in Figure 9.

	Start of Frame (SOF)	Initiator Transport Data Fields
Size (bits)	≥ 80 bits	≥ 136 bits

Figure 9 — Initiator Frame format

Target Frames shall conform to the format shown in Figure 10.

	Start of Frame (SOF)	Target Transport Data Fields
Size (bits)	≥ 80 bits	≥ 40

Figure 10 — Target Frame format

9.2.1 Start of Frame (SOF)

9.2.1.1 Passive communication mode

9.2.1.1.1 Initiator

The SOF is specified in Figure 11 and shall be encoded as specified in 8.3.1.3.

SOF		
PREAMBLE		SYNC
PRE0	PRE1	
≥ 40 bits	24 bits	16 bits
0x00	0x555551	0x1616

Figure 11 — Initiator SOF, Passive communication mode

9.2.1.1.2 Target

In Passive communication mode the Target SOF is specified in Figure 12 and shall be encoded as specified in 8.3.2.3.

SOF	
PRE2	SYNC
≥ 64 bits	16 bits
0101...0101	0x1616

Figure 12 — Target SOF, Passive communication mode

9.2.1.2 Active communication mode

In Active communication mode the SOF shall be the same for both Initiator and Target Frames and shall be identical to the SOF for Passive communication mode Target frames as specified in 9.2.1.1.2.

9.2.2 Transport Data Fields

9.2.2.1 Initiator Transport Data Fields

The Initiator Transport Data Fields comprises a HEADER and may contain a PAYLOAD, each protected by its own 32 bit CRC.

The Initiator Transport Data Fields shall be used in both Active and Passive communication modes.

The PAYLOAD data contained in PLD may contain data directly addressed by the HEADER (see Clause 14), or it may contain an MSIP-1 Transport data field (see MSIP-1 Transport Protocol, Clause 13). The type of PAYLOAD information is indicated in the HEADER. Clauses 13 and 14 specify in detail how PLD is structured and its length specified.

When no PLD is present there shall not be a CRCP.

Initiator Transport Data Fields			
HEADER		PAYLOAD	
Initiator HEADER Data Fields	CRCH	PLD	CRCP
104 bits	32 bit	≥ 0	32 bit

Figure 13 — Initiator Transport Data Fields

9.2.2.1.1 Initiator HEADER Data Fields

This HEADER is used for all Initiator Transport Data Fields, as specified in Figure 14.

CHAN: The header frame shall begin with a 4 bit (CHAN) field that specifies which channel this frame is applied to. The target shall only process frames with CHAN value matching their own channel ID or frames with CHAN value equal to 0xFF (broadcast channel).

SOC: The 12 bit SOC field specifies which socket this frame is applied to; it immediately follows the CHAN field. The targets shall only process frames with SOC value matching their own channel ID except for CMD3 values 0xFF (ResetID) and 0xFE (ReportID).

CMD3: The CMD3 field specifies which operation the target is requested to perform. This 8 bit field shall consist of a number between 0x00 to 0x08 and 0xFE and 0xFF. All other values are reserved for future use.

CMD3_EX: The command extension field (CMD3_EX) shall be 48 bits. This field provides additional information on the CMD3 field. The significance of each bit within this field is CMD3 dependent. When the CMD3_EX field is used for direct memory access applications it may be further sub-divided into two fields – ADDR and LEN, to allow direct addressing of up to 64kbyte blocks of a 32 bit address space.

Initiator HEADER Data Fields				
CHAN	SOC	CMD3	CMD3_EX	
			ADDR	LEN
4 bit	12 bit	8 bit	32 bit	16 bit

Figure 14 — Initiator Header

9.2.2.1.2 CRCH

The CRCH field is a 32 bit CRC value of the fields CHAN, SOC, CMD3, and CMD3_EX concatenated together.

9.2.2.1.3 PLD

The PLD field is of variable length, and may be zero length.

9.2.2.1.4 CRCP

If PLD is one or more bytes long, then it shall be protected by a 32 bit CRC – CRCP – calculated over the length of PLD.

9.2.2.2 Target Transport Data Fields

The Target Transport Data Fields comprises an initial response byte – CMD3 – followed by a variable length payload – PLDT.

CMD3 and PLDT concatenated together are then protected by a 32 bit CRC – CRCT.

The Target Transport Data Fields shall be used in both Active and Passive communication modes.

Figure 15 specifies the Target Transport Data Fields structure:

Target Transport Data Fields		
CMD3	PLDT	CRCT
8 bits	≥ 0	32 bits

Figure 15 — Target Transport Data Fields

CMD3: Target’s response code. Allowed response codes are defined in Clause 14.

PLDT: Target’s Payload. The size of this field is dependent on the requested operation and may be zero.

CRCT: CRC of CMD3 and PLDT field only; this field shall consist of 32 bits. If the PLDT field is absent, CRCT shall be computed on the CMD3 field only.

10 General Protocol flow

Any MSIP-1 device shall initially be a Target.

The MSIP-1 device may choose to operate in either Active or Passive communication mode.

10.1 describes the overall protocol flow when Passive communication mode is selected, and 10.2 describes the overall protocol flow for Active communication mode.

10.1 Protocol flow for Passive communication mode

Figure 16 describes the overall protocol flow when the Passive communication mode is selected by the Initiator.

There are five phases to the protocol:

1. Initialisation and Single Device Detection (see Clause 11)
 - a. The Initiator shall perform the initial RF Collision Avoidance (RFCA) sequence as defined in 11.2.1.
 - b. The Initiator shall switch to Passive communication mode.
 - c. The Initiator shall perform the Initialisation and SDD (see 11.3, 11.4, 11.5).
2. Determine Protocol Support (see Clause 12)
 - a. The Initiator shall read the PROTOCOL value from the Target (see 12.1).
 - b. The Target shall respond with its PROTOCOL value (see 12.2).
 - c. If the Target supports the MSIP-1 transport protocol, the Initiator proceeds to activate the MSIP-1 Protocol.
3. Protocol Activation and Parameter Selection (see 13.3)
 - a. The Target may fall back to the Initialisation and SDD if no ATR_REQ is supported.
 - b. The ATR_REQ may be sent by the Initiator as a next command after receiving the Attribute Request.
 - c. The Target shall send its ATR_RES as answer to the ATR_REQ. The Target shall only answer to the ATR_REQ if the ATR_REQ is received directly after selection.
 - d. If the Target supports any changeable parameter in the ATR_REQ, a PSL_REQ may be used by the Initiator as the next command after receiving the ATR_REQ to change parameters.
 - e. The Target shall send a PSL_RES as answer to the PSL_REQ.
 - f. A Target does not need to complement the parameter selection, if it does not support any changeable parameters in the ATR_RES.
4. Data Exchange (see 13.4)
 - a. The transparent data shall be sent using the data exchange transport protocol.
5. Deactivation of the protocol (see 13.5)
 - a. The Initiator may send either a DSL_REQ to deselect the Target or send a RLS_REQ to return the Target to its power-on reset condition as exists at the start of initialisation and device detection.
 - b. The Target shall respond to a DSL_REQ with a DSL_RES, or respond to a RLS_REQ with a RLS_RES.

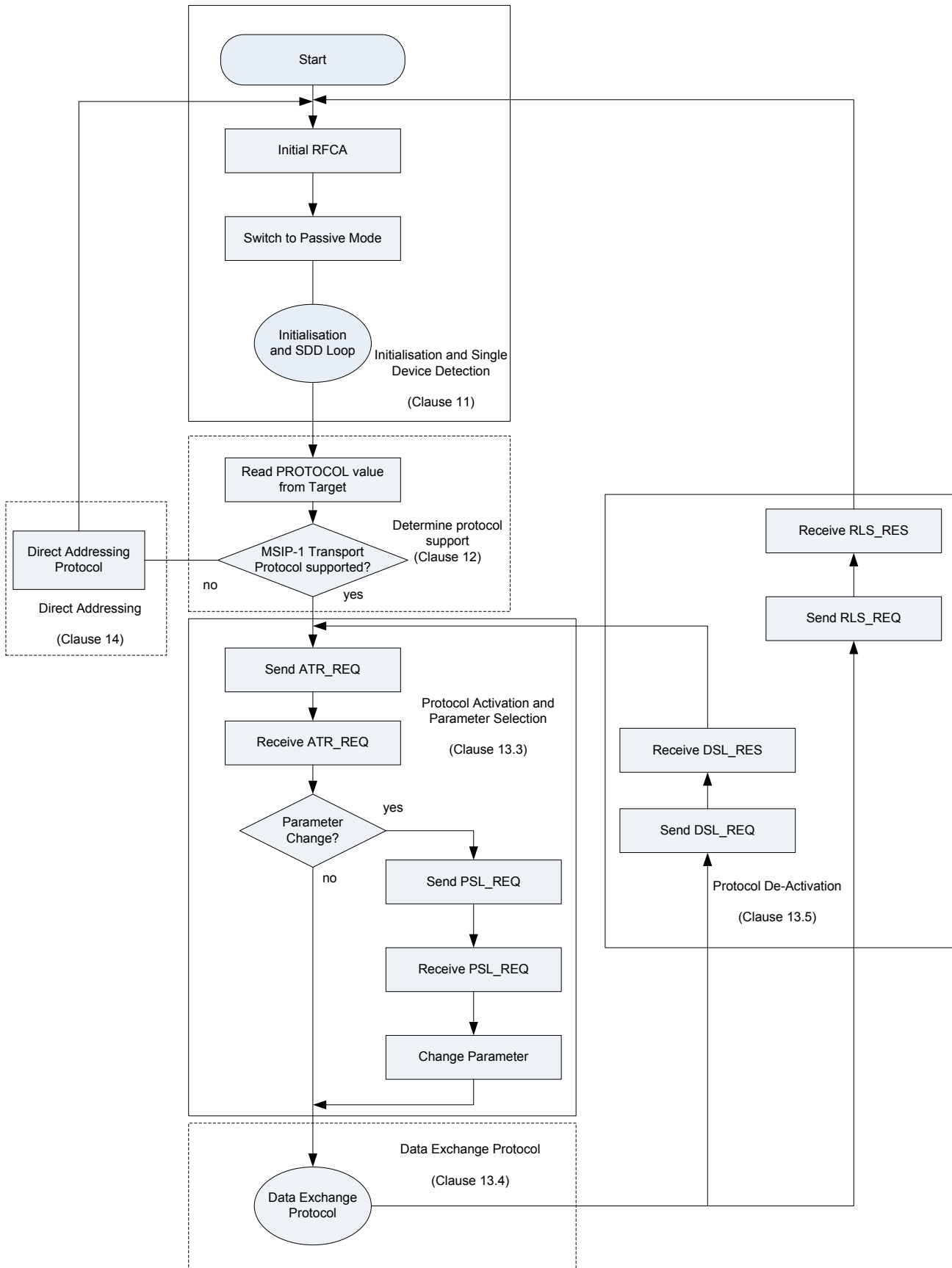

Figure 16 — Protocol in Passive communication mode

10.2 Protocol flow for Active communication mode

Figure 17 describes the overall protocol flow when the Active communication mode is selected by the Initiator.

There are five phases to the protocol:

1. Initialisation (see Clause 11)
 - a. The Initiator shall perform the initial RF Collision Avoidance sequence as defined in 11.2.1.
 - b. The Initiator shall switch to the Active communication mode.
 - c. The Initiator shall perform the Initialisation and SDD (see 11.3, 11.4, 11.5).
2. Determine Protocol Support (see Clause 12)
 - a. The Initiator shall read the PROTOCOL value from the Target (see 12.1).
 - b. The Target shall respond with its PROTOCOL value (see 12.2).
 - c. If the Target supports the MSIP-1 transport protocol, the Initiator proceeds to activate the MSIP-1 Protocol.
3. Protocol Activation and Parameter Selection (see 13.3)
 - a. The Initiator shall send the ATR_REQ. If the Initiator supports the NFC-SEC extension to MSIP-1, it shall indicate that in the ATR_REQ.
 - b. The Target shall send its ATR_RES in response to the ATR_REQ. After a successful response the device is selected. If the Target supports the NFC-SEC extension to MSIP-1, it shall indicate that in the ATR_RES.
 - c. If the Target supports any changeable parameter in the ATR_RES, a PSL_REQ may be used by the Initiator as the next command after receiving the ATR_RES to change parameters.
 - d. The Target shall send a PSL_RES in response to the PSL_REQ.
 - e. A Target does not need to complement the parameter selection, if it does not support any changeable parameters in the ATR_RES.
4. Data Exchange (see 13.4)
 - a. The transparent data shall be sent using the data exchange transport protocol.
5. Deactivation of the protocol (see 13.5)
 - a. The Initiator may send either a DSL_REQ to deselect the Target or send a RLS_REQ to return the Target to its power-on reset condition as exists at the start of initialisation and device detection.
 - b. The Target shall respond to a DSL_REQ with a DSL_RES, or respond to a RLS_REQ with a RLS_RES.

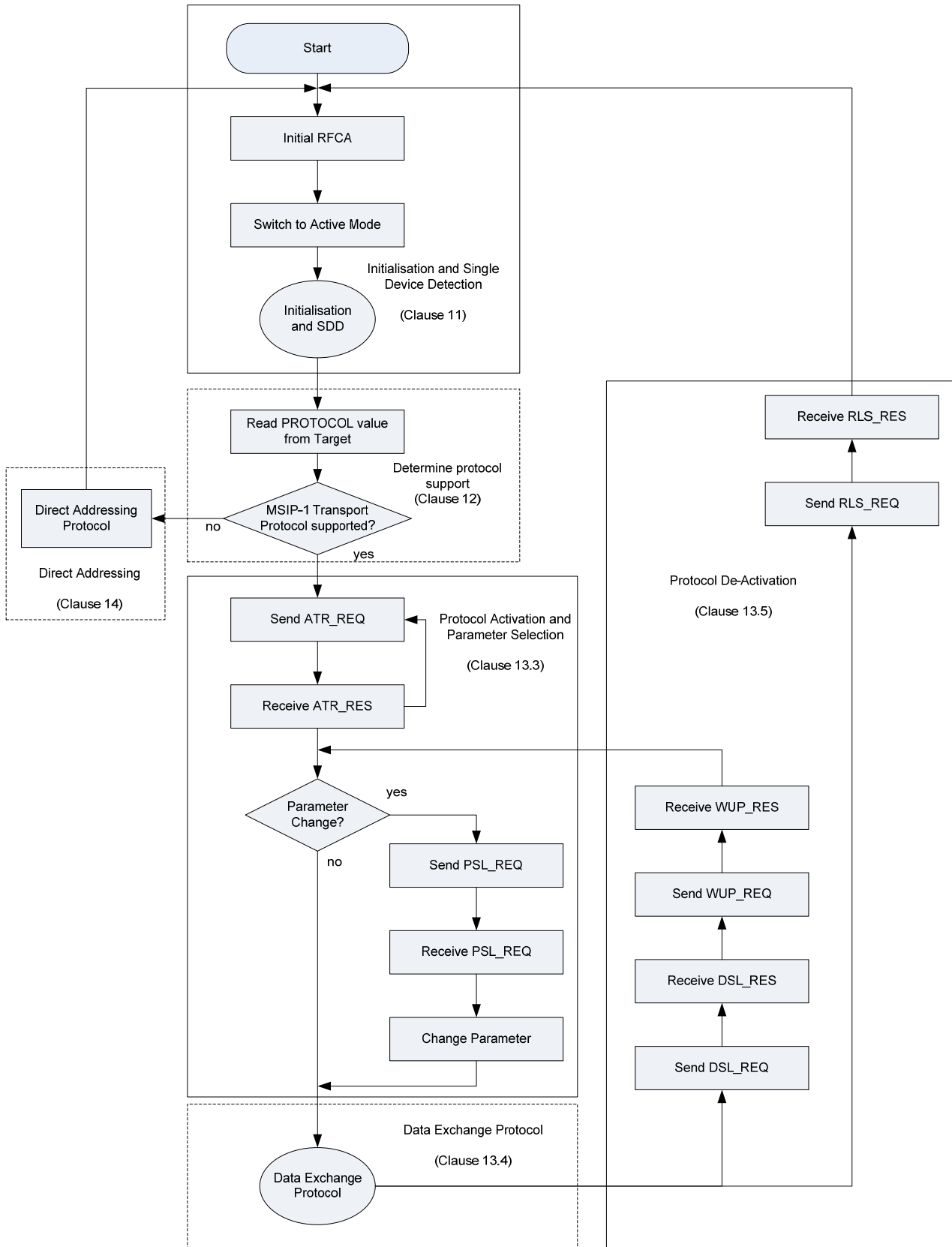

Figure 17 — Protocol in Active communication mode

11 Initialization and Anti-collision

11.1 General

The anti-collision / initialisation sequence is used to isolate Targets of interest by the Initiator in the event where more than one Target is present within the RF field of the Initiator. In the event that only one Target is present, the protocol is designed to quickly identify this condition so as to enable normal data transfer at the earliest possible moment.

11.2 RF Collision Avoidance

In order not to disturb any other MSIP-1 communication and any current infrastructure running on the carrier frequency, an Initiator for MSIP-1 communication shall not generate its own RF field as long as another RF field is detected.

11.2.1 Initial RF Collision Avoidance

To start communication with the Target device either in the Active or the Passive communication mode an Initiator shall sense continuously for the presence of an external RF field. See 7.4.

If the Initiator detects no RF field within the timeframe $T_{IDT} + n \times T_{RFW}$ the Initiator shall switch on its RF field. Figure 18 illustrates the initial RF Collision Avoidance during initialisation.

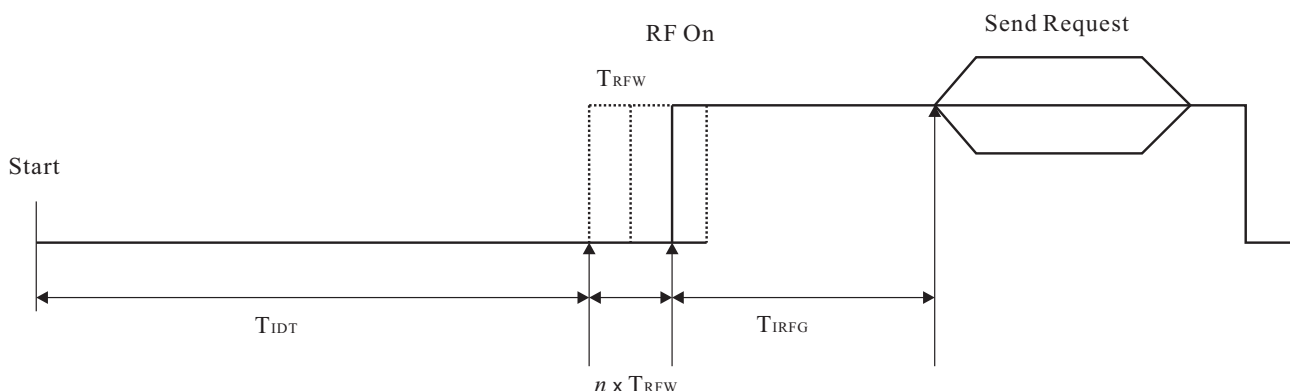

Figure 18 — Initial RF Collision Avoidance

T_{IDT} : Initial delay time. $T_{IDT} > 100 \mu\text{s}$

T_{RFW} : RF waiting time. $24 \mu\text{s}$

n : randomly generated number of Time Periods for T_{RFW}

$$0 \leq n \leq 3$$

T_{IRFG} : Initial guard-time between switching on RF field and start to send command or data frame

$$T_{IRFG} > 25 \mu\text{s}$$

The RF field, which is generated by the Initiator, shall be switched off in the Active communication mode after the Send Request message has been sent. The RF field, which is generated by the Initiator, shall not be switched off in the Passive communication mode.

The Initiator shall use Initial RF Collision Avoidance only for protocol activation. Subsequently it shall respect T_{ADT} as defined in 11.2.2 for switching on the RF field.

11.2.2 Response RF Collision Avoidance

After the initial RF Collision Avoidance as described in 11.2.1, a response RF collision avoidance during activation shall be performed in the Active communication mode to avoid collision of data by simultaneous responding of more than one Target. If the Target detects no RF field within the time frame $T_{ADT} + (n \times T_{RFW})$ the Target shall switch on the RF field.

The Target shall use Response RF Collision Avoidance only for protocol activation. Subsequently it shall respect T_{ADT} for switching on the RF field.

Figure 19 illustrates the response RF Collision Avoidance sequence during initialisation.

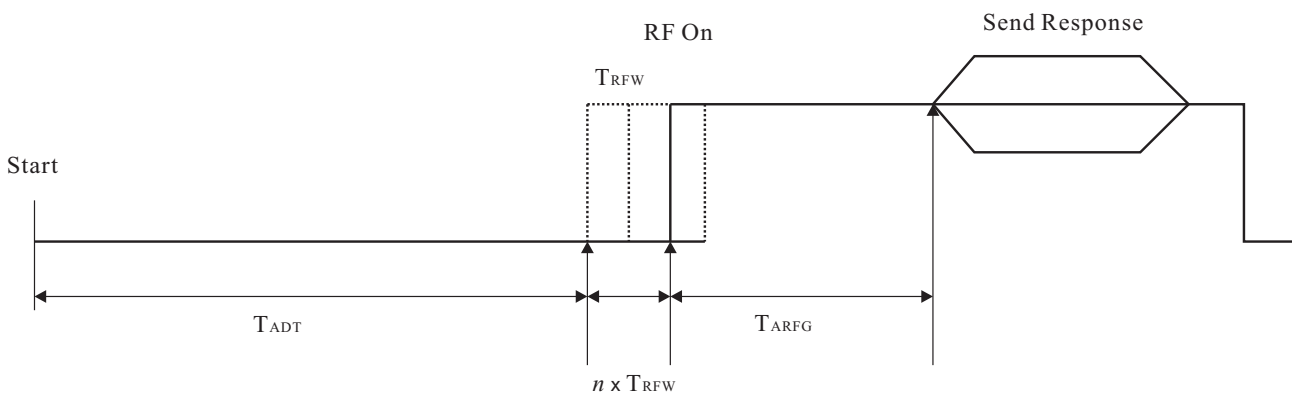

Figure 19 — Response RF Collision Avoidance sequence during activation

T_{ADT} : Active delay time, sense time between RF off Initiator/Target and Target/Initiator

$$(50 \mu\text{s} \leq T_{ADT} \leq 200 \mu\text{s})$$

T_{RFW} : RF waiting time. (24 μs)

n : Randomly generated number of Time Periods for T_{RFW} . ($0 \leq n \leq 3$)

T_{ARFG} : Active guard time between switching on RF field and start to send command

$$(T_{ARFG} > 25 \mu\text{s})$$

11.3 Initialisation and device detection

Figure 20 and Figure 21 illustrate the procedures that are specified in 11.3, 11.4 and 11.5.

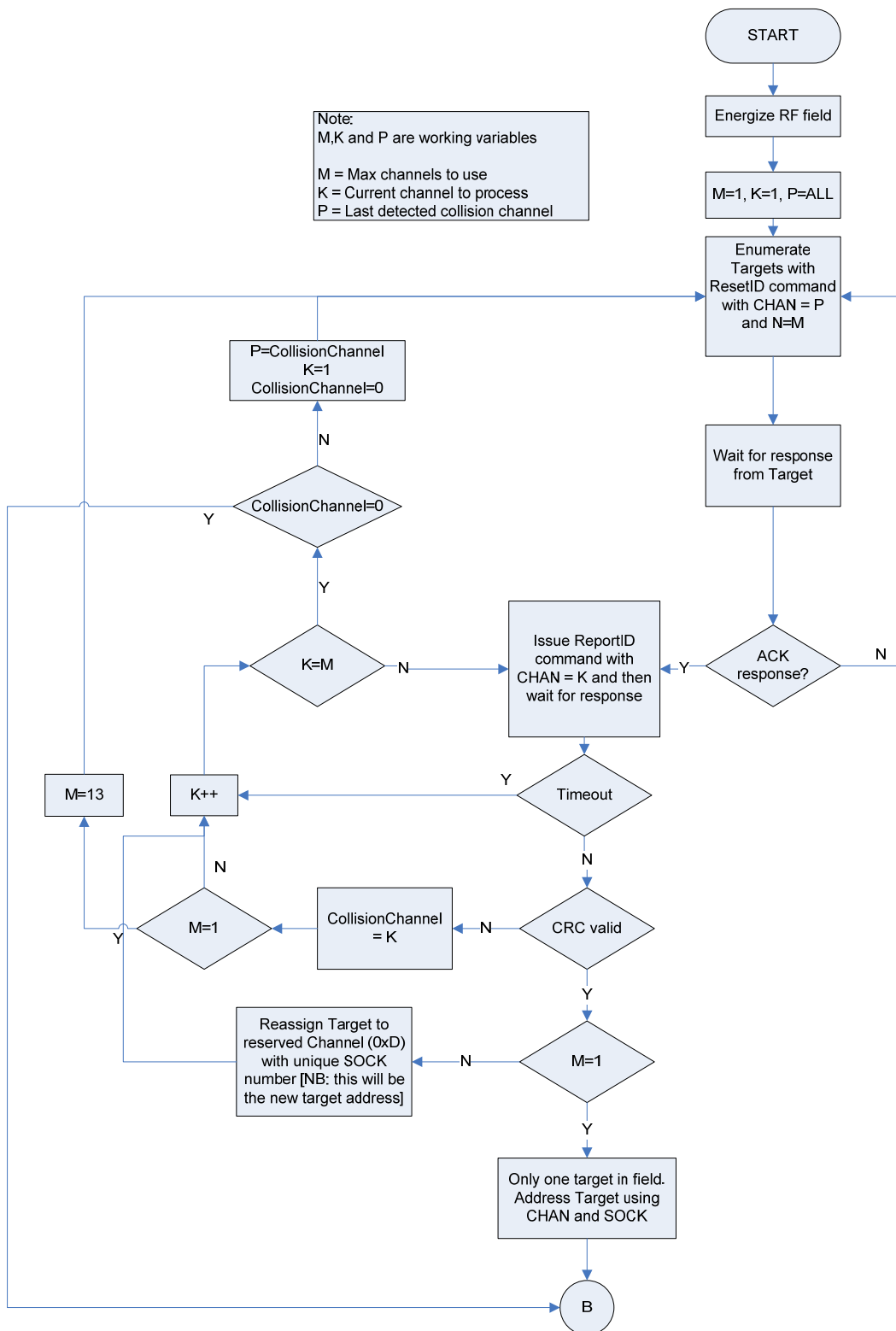

Figure 20 — Initiator Flowchart

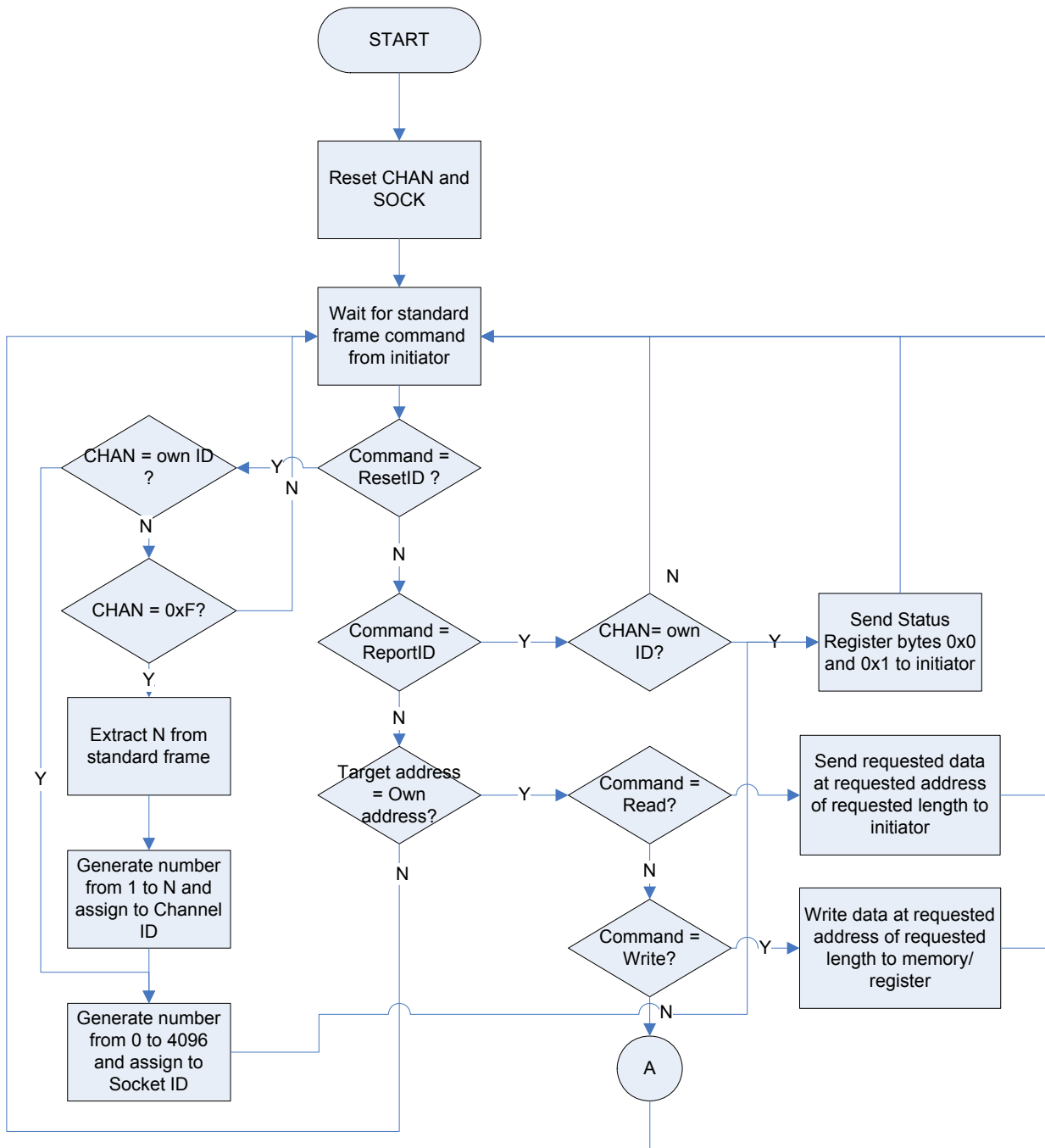

Figure 21 — Target flowchart

The TargetID is the concatenation of the ChannelID and SocketID.

The Target shall reset its TargetID to 0x0000 upon detection of a power-on reset or upon receipt of a ResetID command on the reset channel (CHAN=0x0).

A Target operating in Passive communication mode shall perform a power-on reset when the RF field transmitted by the Initiator has been absent for greater than T_{ADT} .

Command and channel data for initialisation and device detection is encoded in the fields of the HEADER as shown in Figure 23. The ChannelID is encoded in the CHAN field, and the SocketID is encoded in the SOCK field.

The Target shall only process frames with Channel ID and Socket ID matching their own with the following exceptions:

- The Target shall process the 'ResetID' command if it is issued on the Broadcast Channel (CHAN=0xF) or on a channel matching its ChannelID. The Target shall not match the SocketID.
- The Target shall process the 'ReportID' command if it is issued on a channel matching its channelID. The Target shall not match the SocketID.

The device detection scheme shall be the channel selection method. The number of channels shall be given by an integer value N, between 1 and 13 inclusive, which is determined by the Initiator.

If the 'ResetID' command (Figure 23) is issued on the Broadcast Channel, all Targets on all channels shall select a random ChannelID between 1 and N and a SocketID between 0 and 4095. If the 'ResetID' (Figure 24) is issued on a particular channel (y), only Targets operating on channel (y) shall select a random ChannelID between 1 and N and a SocketID between 0 through 4095. Targets operating on all other channels (i.e not y) shall retain their ChannelID and SocketID.

Channel 15 (broadcast)	All Targets shall respond to a ResetID command issued on this channel.
Channel 14 (park)	Targets shall not use this channel when selecting a random ChannelID in response to a ResetID command. The initiator may assign any Target to this channel.
Channel 13	Targets shall select a channel from 1 to N, where N is ≤ 13 , in response to a ResetID command.
Channel 12	
Channel 11	
⋮	
Channel 3	
Channel 2	
Channel 1	
Channel 0 (reset)	All Targets shall default to this channel upon power-on reset.

Figure 22 — MSIP-1 communication channels

SOF		HEADER						
Preamble	SYNC	CHAN	SOCK		CMD3	CMD3_EX		CRCH
						ADDR	LEN	
		4 bits	8 bits	4 bits	8 bits	32 bits	16 bits	32 bits
See Initiator standard frame format		0xF	x	N	0xFF	0x00000100	0x02	CRC

Figure 23 — Initiator to Target broadcast 'ResetID' frame

SOF		HEADER						
Preamble	SYNC	CHAN	SOCK		CMD3	CMD3_EX		CRCH
						ADDR	LEN	
		4 bits	8 bits	4 bits	8 bits	32 bits	16 bits	32 bits
See Initiator standard frame format		0x0	x	N	0xFF	0x00000100	0x02	CRC

Figure 24 — Example: Initiator to Target ‘ResetID’ frame for channel 0

NOTE x denotes any arbitrary values.

Preamble is PRE0, PRE1 for Passive communication mode, PRE2 for Active communication mode.

- CHAN: Channel number this frame is applied to. Valid values are 0 through 15. Channel 15 shall be the Broadcast Channel. All Targets shall respond to a ‘ResetID’ frame if this is issued on a channel matching its ChannelID or on a Broadcast Channel.
- SOCK: The Initiator shall use the lowest 4 bits of the SOCK field to specify the number of channels (N) available for this session. The value shall range from 1 through 13, all other values shall be invalid. The Target shall ignore the 8 most significant bits.
- CMD3: This value shall be 0xFF (ResetID opcode).
- ADDR: This value shall be 0x00000100.
- LEN: This value shall be 0x02.
- CRCH: CRC of fields CHAN, SOCK, CMD3, ADDR, and LEN concatenated together.

The Targets shall respond to the ‘ResetID’ frame with the frame specified in Figure 25.

Preamble	SYNC	CMD3	CHAN	SOCK	CRCT
		8 bits	4 bits	12 bits	32 bits
See Initiator standard frame format		0xFE	C	S	CRC

Figure 25 — ResetID response frame format

Preamble is PRE2 for both Active and Passive communication mode response

- CMD3: This value shall be 0xFE (8 bits).
- CHAN: This value, C, shall be the Target’s ChannelID.
- SOCK: This value, S, shall be the Target’s SocketID.
- CRCT: CRC of fields CMD3, CHAN, and SOCK concatenated together.

11.4 Single Device Detection (SDD)

If the Response Frame to a ResetID issued on the Broadcast Channel is decoded with no CRC errors, then only one Target exists within the operating volume; in this situation the enumeration process is completed and the Initiator can now uniquely address the Target using the CHAN and SOCK values returned by the Target.

11.5 Multiple device detection and isolation

If a reply is received from the Target in response to a 'ResetID' command or ReportID command issued on the Broadcast Channel and is decoded with CRC errors, then a collision is deemed to have occurred. The Initiator shall proceed with the next phase of the anticollision sequence to enumerate and isolate the Targets.

The Initiator shall send a 'ReportID' frame (Figure 26) on the channels it wishes to enumerate. Only Targets with ChannelID matching the CHAN field of the 'ReportID' frame shall respond to the frame.

SOF		HEADER					
Preamble	SYNC	CHAN	SOCK	CMD 3	CMD_EX		CRCH
					ADDR	LEN	
		4 bits	12 bits	8 bits	32 bits	16 bits	32 bits
See Initiator standard frame format		C	x	0xFE	00000100	0x02	CRC

Figure 26 — Initiator to Target broadcast 'ReportID' frame

NOTE x denotes any arbitrary values.

Preamble is PRE0, PRE1 for Passive communication mode, PRE2 for Active communication mode

- CHAN: C = Channel number this frame is applied to. Valid values are 0 through 14. The Target shall respond to 'ReportID' frame if the CHAN field matches it own ChannelID field.
- SOCK: This field shall be 12 bit. The Target shall ignore this field.
- CMD3: This value shall be 0xFE (Report ID opcode).
- ADDR: This value shall be 0x00000100.
- LEN: This value shall be 0x02.
- CRCH: CRC of fields CHAN, SOCK, CMD3, ADDR, LEN; this field shall be 32 bits.

The Target shall reply with the 'ReportID' response frame (Figure 27).

Preamble	SYNC	CMD3	CHAN	SOCK	CRCT
		8 bits	4 bits	12 bits	32 bits
See Target standard frame format		0xFE	C	S	CRC

Figure 27 — ReportID response frame format

Preamble is PRE2 for both Active and Passive Mode Response.

- CMD3: This value shall be 0xFE.
- CHAN: This value, C, shall be the Target's ChannelID.
- SOCK: This value, S, shall be the Target's SocketID.
- CRCT: CRC of fields CMD3, CHAN, and SOCK concatenated together.

If a reply is received from the Target in response to a 'ReportID' frame issued on a particular channel (x) and decoded with no CRC error, only one Target is deemed to exist on that channel (x), otherwise the procedure specified in 12.5 shall be reapplied.

The Initiator may reassign the Target to another channel, including the Park Channel, by issuing a ChangeID frame as described in Figure 28. Within the ChangeID frame it may also change the SocketID.

SOF		HEADER					PAYLOAD			
Preamble	SYNC	CHAN	SOC	CMD3	CMD_EX		CRCH	NEWCHAN	NEWSOCK	CRCP
	16 bit				4 bit	12 bit				
					ADDR	LEN				
					32 bit	16 bit				
See Initiator standard frame format		C	S	0x01	0x00000100	0x02	CRC	NC	NS	CRC

Figure 28 — Initiator to Target 'ChangeID' frame format

Preamble is PRE0, PRE1 for Passive communication mode, PRE2 for Active communication mode

- CHAN: C = Channel number received from the Target in the Target's ReportID frame.
- SOCK: S = Socket number received from the Target in the Target's ReportID frame.
- CRCH: CRC of CHAN,SOC,CMD3,ADDR,LEN fields.
- NEWCHAN: New CHAN, NC, assigned to Target by Initiator.
- NEWSOCK: New SOCK, NS, assigned to Target by Initiator.
- CRCP: CRC of Concatenation of NEWCHAN and NEWSOCK fields.

The Initiator may repeat the multiple Targets detection and isolation sequence, (this time on channels with collision) until all Targets have been isolated.

12 Protocols

This specification defines two protocols:

1. MSIP-1 Transport Protocol
This is a Transport Protocol closely related to the NFCIP-1 Transport Protocol.
2. Direct Addressing Protocol:
Using this protocol, data and message fields in a Target may be accessed directly by an Initiator by specifying an address and length using fields in the HEADER. This protocol is most suitable for accessing Passive Targets where processing resources are limited.

The Initiator shall determine the Target's support for these protocols by using the following command and response:

12.1 Reading the PROTOCOL value: Initiator command

An Initiator Frame as defined in Clause 9 shall be sent with the following Transport Data Field values:

- CHAN: determined by Initiator during Initialization (see Clause 11)

- SOC: determined by Initiator during Initialization (see Clause 11)
- CMD3: 0x00
- ADDR: 0x00000010
- LEN: 0x0001
- CRCH: CRC of concatenation of CHAN, SOC, CMD3, ADDR, LEN fields.

12.2 Reading the PROTOCOL value: Target response

A Target shall respond to the command defined in 12.1 with the following values in its Target Transport Data Fields:

- CMD3: 0x00
- PLDT: PROTOCOL byte as defined in 14.11.1.1
- CRCT: CRC of the concatenation of the CMD3 and PLDT fields.

13 MSIP-1 Transport Protocol

The MSIP-1 Transport Protocol is derived from the NFCIP-1 Transport Protocol and supports all of NFCIP-1's Transport Protocol features.

13.1 Transport Data

13.1.1 Initiator to Target frame

Figure 29 specifies the overall packet structure of an MSIP-1 Transport Protocol transmission from Initiator to Target. The Initiator Transport Data Fields with format is specified in 9.2.2.1 shall be used, with the following values:

- CHAN: determined by Initiator during Initialization (see Clause 11)
- SOC: determined by Initiator during Initialization (see Clause 11)
- CMD3: 0x07
- ADDR: RFU
- LEN1, LEN2: Bytes LEN1 and LEN2 shall indicate the length of PLDI. LEN1 is the MSB of the 16 bit length, LEN2, is the LSB. PLDI shall be a maximum of 65535 bytes
- CRCH: is the 32 bit CRC computed over (CHAN || SOC || CMD3 || ADDR || LEN)
- PLDI: Shall contain the MSIP-1 Transport Data as defined in 13.3, 13.4 and 13.5
- CRCP is the 32 bit CRC computed over the PLDI.

SOF		Initiator Transport Data Fields												
Preamble	SYNC	HEADER							PAYLOAD					
		CHAN	SOC	CMD3	ADDR	LEN1	LEN2	CRCH	PLDI					CRCP
									MSIP-1 Transport Data					
									CMD0	CMD1	Byte0	Byte1	Byte2	

Figure 29 — MSIP-1 Frame Format – Initiator to Target

13.1.2 Target to Initiator frame

The Target Transport Data Fields as specified in Figure 30 and whose format is described in 9.2.2.2 shall be used with the following values:

- CMD3: 0x07
- PLDT: Shall contain the MSIP-1 Transport Data packet as defined in 13.3, 13.4 and 13.5 pre-pended by two bytes - LEN1 and LEN2. Bytes LEN1 and LEN2 shall contain the 16-bit length of the MSIP-1 Transport data, including the CMD0 and CMD1 bytes. LEN1 is the MSB of the 16 bit length, LEN2, is the LSB.
- CRCT: is the 32 bit CRC computed over (CMD3 || PLDT)

SOF		Target Transport Data Fields											
PRE2	SYNC	CMD3	PLDT									CRCT	
			MSIP-1 Transport Data										
			LEN1	LEN2	CMD0	CMD1	Byte0	Byte1	Byte2	Byte n		

Figure 30 — Frame Format - Target to Initiator

13.2 Commands

The Command Bytes shall consist of 2 bytes. The first shall be CMD0 and the second shall be CMD1. The Commands are defined Table 9.

Table 9 — MSIP-1 Protocol Command Set

Mnemonic	Command		Definition
	CMD0	CMD1	
ATR_REQ	(D4)	(00)	Attribute Request (sent by Initiator)
ATR_RES	(D5)	(01)	Attribute Response (sent by Target)
WUP_REQ	(D4)	(02)	Wakeup Request (sent by Initiator in Active mode only)
WUP_RES	(D5)	(03)	Wakeup Response (sent by Target in Active mode only)
PSL_REQ	(D4)	(04)	Parameter selection Request (sent by Initiator)
PSL_RES	(D5)	(05)	Parameter selection Response (sent by Target)
DEP_REQ	(D4)	(06)	Data Exchange Protocol Request (sent by Initiator)
DEP_RES	(D5)	(07)	Data Exchange Protocol Response (sent by Target)
DSL_REQ	(D4)	(08)	Deselect Request (sent by Initiator)
DSL_RES	(D5)	(09)	Deselect Response (sent by Target)
RLS_REQ	(D4)	(0A)	Release Request (sent by Initiator)
RLS_RES	(D5)	(0B)	Release Response (sent by Target)

13.3 Activation of the protocol

13.3.1 Attribute Request and Response Commands

13.3.1.1 Attribute Request (ATR_REQ)

The Initiator shall send the ATR_REQ to the selected Target:

CMD0	CMD1	Byte 0	...	Byte 9	Byte 10	Byte 11	Byte 12	Byte 13	Byte 14	...	Byte <i>n</i>
(D4)	(00)	nfcid3i0	...	nfcid3i9	DID _i	BS _i	BR _i	PP _i	[Gi[0]]	...	[Gi[<i>n</i>]]

Figure 31 — Structure of the ATR_REQ

13.3.1.1.1 Definition of the ATR_REQ bytes

CMD0: Shall be set to (D4).

CMD1: ATR_REQ

The ATR_REQ byte shall specify the Attribute Request for the Initiator. The value of ATR_REQ shall be set to (00).

Byte 0 to Byte 9: NFCID3_i

The 10 nfcid3_i bytes define the random identifier NFCID3_i of the Initiator. NFCID3 shall be an ID dynamically generated by the application and be fixed during one communication.

Byte 10: DIDi

The DIDi byte shall be used for multiple data transport protocol activation with more than one Target. The range of the DIDi shall be defined between 1 and 14. The value ZERO shall be used, if no DIDi is used during the data transport protocol. All other values are prohibited.

Byte 11: BSi

Bits 3 to 0 of the BSi byte shall indicate the send bit rates that the Initiator supports:

bit 7	bit 6	bit 5	bit 4	bit 3	bit 2	bit 1	bit 0
ZERO	ZERO	ZERO	ZERO	DSi	DSi	DSi	DSi

Figure 32 — BSi byte

- bit 7 to bit 4: shall be set to ZERO, all other values are RFU
- bit 3: DSi = 160 Mbps supported, shall be set to ZERO, RFU
- bit 2: DSi = 80 Mbps supported, shall be set to ZERO, RFU
- bit 1: DSi = 40 Mbps supported, shall be set to ZERO, RFU
- bit 0: DSi = 20 Mbps supported, shall be set to ZERO, RFU

10 Mbps shall be supported – see Clause 8.

Byte 12: BRi

Bits 3 to 0 of the BRi byte shall indicate the receive bit rates that the Initiator supports:

bit 7	bit 6	bit 5	bit 4	bit 3	bit 2	bit 1	bit 0
ZERO	ZERO	ZERO	ZERO	DRi	DRi	DRi	DRi

Figure 33 — BRi byte

- bit 7 to bit 4: shall be set to ZERO, all other values are RFU
- bit 3: DRi = 160 Mbps supported, shall be set to ZERO, RFU
- bit 2: DRi = 80 Mbps supported, shall be set to ZERO, RFU
- bit 1: DRi = 40 Mbps supported, shall be set to ZERO, RFU
- bit 0: DRi = 20 Mbps supported, shall be set to ZERO, RFU

10 Mbps shall be supported – see Clause 8.

Byte13: P*Pi*

The P*Pi* byte specifies optional parameters used by Initiator:

bit 7	bit 6	bit 5	bit 4	bit 3	bit 2	bit 1	bit 0
SE <i>Ci</i>	RFU	LR <i>i</i>	LR <i>i</i>	RFU	RFU	Gi	NAD

Figure 34 — P*Pi* byte

- bit 7: SE*Ci*. The Initiator shall set SE*Ci* to ONE if the Initiator supports the NFC-SEC extension; ZERO Indicates no support
- bit 6: RFU. The Initiator shall set it to ZERO. The Target shall ignore it.
- bit 5 and bit 4: Length Reduction value:

Table 10 — Definition of LR*i*

LR <i>i</i>	LEN _{MAX}
00	Only Byte 0 to Byte 255 is valid in the Transport Data
01	Only Byte 0 to Byte 1023 is valid in the Transport Data
10	Only Byte 0 to Byte 4095 is valid in the Transport Data
11	Only Byte 0 to Byte 65535 is valid in the Transport Data

- bit 3 and bit 2: RFU. The Initiator shall set it to ZERO. The Target shall ignore it.
- bit 1: If bit is set to ONE then it indicates General bytes are available.
- bit 0: If bit is set to ONE then it indicates the Initiator uses NAD.

Byte 14 to Byte *n*: G*i*[0] to G*i*[*n*]

The General bytes **G[0] to G[*n*]** shall be optional and designate general information. The maximum length of the ATR_REQ subtracted by the mandatory bytes give the maximum number of General bytes.

13.3.1.2 Attribute Response (ATR_RES)

The selected MSIP-1 Target device shall send the ATR_RES within 10 ms after receiving the ATR_REQ:

CMD0	CMD1	Byte 0	...	Byte 9	Byte 10	Byte 11	Byte 12	Byte 13	Byte 14	Byte 15	...	Byte <i>n</i>
(D5)	(01)	nfcid3t0	...	nfcid3t9	DIDt	BSt	BRt	TO	PPT	Gt[0]	...	Gt[<i>n</i>]

Figure 35 — Structure of the ATR_RES

13.3.1.2.1 Definition of the ATR_RES bytes

CMD0: Shall be set to (D5).

CMD1: ATR_RES

The ATR_RES byte shall specify the Target’s Response to the ATR_REQ send by the Initiator. The value of CMD1 for ATR_RES shall be set to (01).

Byte 0 to Byte 9: NFCID3t

The 10 nfcid3t bytes define the random identifier NCID3t of the Target. NFCID3 should be an ID generated by the application.

Byte 10: DIDt

The DIDt byte shall be used for multiple data transport protocol activation with more than one Target. The DIDt shall have the same value as the DIDI. All other values are prohibited. For usage of DIDt, see 13.3.1.1.1.

Byte 11: BSt

Bit 3 to 0 of BSt indicate the supported transmit bit rate of the Target device:

bit 7	bit 6	bit 5	bit 4	bit 3	bit 2	bit 1	bit 0
ZERO	ZERO	ZERO	ZERO	BSt	BSt	BSt	BSt

Figure 36 — BSt byte

- bit 7 to bit 4: Shall be set to ZERO
- bit 3: BSt = 160 Mbps supported, shall be set to ZERO, RFU
- bit 2: BSt = 80 Mbps supported, shall be set to ZERO, RFU
- bit 1: BSt = 40 Mbps supported, shall be set to ZERO, RFU
- bit 0: BSt = 20 Mbps supported, shall be set to ZERO, RFU

10 Mbps shall be supported – see Clause 8.

Byte 12: BRt

Bit 3 to 0 of BRt shall indicate the supported receive bit rates of the Target device:

bit 7	bit 6	bit 5	bit 4	bit 3	bit 2	bit 1	bit 0
ZERO	ZERO	ZERO	ZERO	BRt	BRt	BRt	BRt

Figure 37 — Coding of the BRt byte

- bit 7 to bit 4: Shall be set to ZERO
- bit 3: BRt = 160 Mbps supported, shall be set to ZERO, RFU
- bit 2: BRt = 80 Mbps supported, shall be set to ZERO, RFU
- bit 1: BRt = 40 Mbps supported, shall be set to ZERO, RFU
- bit 0: BRt = 20 Mbps supported, shall be set to ZERO, RFU

10 Mbps shall be supported – see Clause 8.

Byte 13: TO

The TO byte shall specify the timeout value of the Target MSIP-1 device for the data transport protocol. The timeout calculation shall start with the last bit sent by the Initiator and stop with the first bit sent by the Target. The timeout is specified as follows:

bit 7	bit 6	bit 5	bit 4	bit 3	bit 2	bit 1	bit 0
ZERO	ZERO	ZERO	ZERO	WT	WT	WT	WT

Figure 38 — TO byte

- bit 7 to bit 4: Shall be set to all ZEROs.
- bit 3 to bit 0: WT: Waiting Time.

The Response Waiting Time (RWT) shall be calculated by the following formula:

$$RWT = 302 \times 2^{WT} \mu s$$

Where the value of WT shall be the range from 0 to 14 and the value of 15 is RFU.

For WT = 0, RWT = RWT_{MIN} (302 μs)

For WT = 14, RWT = RWT_{MAX} (4949 ms)

Byte 14: PPt

The PPt byte specifies optional parameters used by Target device:

bit 7	bit 6	bit 5	bit 4	bit 3	bit 2	bit 1	bit 0
SEct	RFU	LRt	LRt	RFU	RFU	Gt	NAD

Figure 39 — PPt byte

- bit 7: SEct. The Target shall set SEct to ONE if the Target supports the NFC-SEC extension; ZERO Indicates no support.
- bit 6: RFU. The Initiator shall set it to ZERO. The Target shall ignore it.
- bit 5 and bit 4: Length Reduction value:

Table 11 — Definition of LRt

LRt	LEN _{MAX}
00	Only Byte 0 to Byte 255 is valid in the Transport Data
01	Only Byte 0 to Byte 1023 is valid in the Transport Data
10	Only Byte 0 to Byte 4095 is valid in the Transport Data
11	Only Byte 0 to Byte 65535 is valid in the Transport Data

- bit 3 and bit 2: RFU. The Initiator shall set it to ZERO. The Target shall ignore it.
- bit 1: If bit is set to ONE then it indicates General bytes available.

- bit 0: If bit is set to ONE then it indicates the Target uses NAD.

Byte 14 to Byte n : Gt[0] to Gt[n]

Gt[0] to Gt[n] shall be optional and designate General information. The maximum length of the ATR_RES subtracted by the mandatory bytes gives the maximum number of General bytes.

13.3.1.3 Handling of ATR_REQ and ATR_RES

13.3.1.3.1 Initiator rules

After reception of a valid ATR_RES, the Initiator may check if the Target supports MSIP-1 extensions. In case such extensions match the Initiators capabilities it may chose to use MSIP-1 extensions.

In any other case the Initiator may retransmit the ATR_REQ before it uses the deactivation sequence as defined in 13.5.

13.3.1.3.2 Target rules

When the Target:

- a) Receives a valid ATR_REQ, the Target
 - shall send its ATR_RES,
 - shall ignore subsequent ATR_REQs if any other valid command has been received.
- b) Receives any other valid or invalid frame the Target
 - shall ignore the block and
 - shall remain in receive mode.

13.3.1.4 Handling of timeout TO

The handling of the timeout is different for active and passive communication mode.

13.3.1.4.1 Handling in active mode

In active communication mode the protocol together with the Initiator switching the carrier on and off, handle the timeout behaviour.

Initiator: The Initiator shall ignore a Target that exceeded RWT calculated using TO byte in ATR_RES from a Target device and continue operation.

Target: The Target shall specify a TO value suitable for common communication and may specify a timeout extension to the RWT in a supervisory PDU, see 13.4.1.1.1.

13.3.1.4.2 Handling of timeout in passive mode

In passive communication mode only the protocol handles timeout behaviour.

Initiator: The Initiator shall first use error handling and if no response is received, it shall ignore Targets that exceeded the specified timeout and it shall continue communication.

Target: The Target shall specify a TO value suitable for common communication and may specify a timeout extension to the RWT in a supervisory PDU, see 13.4.1.1.1.

13.3.1.5 Handling of DID

13.3.1.5.1 Handling of DID in active and in passive mode.

When the Initiator has sent a ATR_REQ containing a DID equal to ZERO and

- a) received an ATR_RES containing DID equal to ZERO
 - shall send PDU's containing no DID to the Target and
 - shall not activate any other Target while this Target is not deactivated.
- b) received an ATR_RES containing DID not equal to ZERO
 - shall continue with error handling.

When the Initiator has sent a ATR_REQ containing a DID not equal to ZERO and

- a) received an ATR_RES containing the same DID
 - shall send PDU's containing the DID to the Target and
 - shall not use the DID for any other Targets and
 - shall not use DID=0 for any other Targets.
- b) received an ATR_RES containing any other DID
 - shall continue with error handling.

13.3.2 Wakeup Request and Response Commands

The Wakeup Request and Response commands are only defined for the Active communication mode.

13.3.2.1 Wakeup Request (WUP_REQ)

This Clause defines the Wakeup Request for Attributes WUP_REQ with its parameter bytes. The Initiator sends the WUP_REQ to the Target only in the Active communication mode. It shall be applied to reactivate a distinct Target device by its NFCID3, which was deactivated by the DSL command.

CMD0	CMD1	Byte 0	...	Byte 9	Byte 10
(D4)	(02)	nfcid3t0	...	nfcid3t9	DID

Figure 40 — Structure of the WUP_REQ

13.3.2.1.1 Definition of the WUP_REQ bytes

CMD0: Shall be set to (D4).

CMD1: WUP_REQ

The WUP_REQ byte shall specify the command Wake Up for the Initiator device. The value of WUP_REQ shall be (02).

Byte 0 to Byte 9: NFCID3t

The 10 nfcid3t bytes shall be defined as the random identifier of the Target. For the WUP_REQ command the Initiator shall send the known NFCID3t random identifier to wake up the Target.

Byte 10: DID

The DID byte shall be used for multiple data transport protocol activation with more than one Target. The range of the DID shall be defined between 1 and 14. The value 0 shall be used, if no DID is used during the data transport protocol. All other values are prohibited by this Standard. The Initiator may assign a different value to the Target, as used before the last DSL command.

13.3.2.2 Wakeup Response (WUP_RES)

This Clause defines the Wakeup Response for attributes WUP_RES. The WUP_RES shall be the response to the WUP_REQ and shall be sent by the selected MSIP-1 Target device.

CMD0	CMD1	Byte 0
(D5)	(03)	DID

Figure 41 — Structure of the WUP_RES

13.3.2.2.1 Definition of the WUP_RES bytes

CMD0: Shall be set to (D5).

CMD1: WUP_RES

The WUP_RES byte shall specify the response to the WUP_REQ. The value of WUP_RES shall be (03).

Byte 0: DID

The DID byte shall be used for multiple data exchange protocol activation with more than one Targets. The DIDt shall have the same value as the DIDi. All other values are prohibited by this Standard.

13.3.2.3 Handling of WUP_REQ and WUP_RES

13.3.2.3.1 Initiator rules

When the Initiator has sent a WUP_REQ and receives a valid WUP_RES the Initiator shall continue with operation.

In any other case the Initiator shall retransmit the WUP_REQ at least once before it shall use the deactivation sequence as defined in 14.7.

13.3.2.3.2 Target rules

When the Target has been de-selected by the last command (for the Active communication mode only) and

- a) receives a WUP_REQ with its NFCID3, the Target
 - shall send its WUP_RES and
 - shall ignore any subsequent WUP_REQ.

b) receives any other valid or invalid frame, the Target

- shall ignore the block and
- shall remain in receive mode.

13.3.3 Parameter Selection Request and Response Commands

13.3.3.1 Parameter Selection Request (PSL_REQ)

The Initiator may switch parameters for the subsequent transport protocol using the PSL_REQ command.

CMD0	CMD1	Byte 0	Byte 1	Byte 2
(D4)	(04)	DID	BRS	FSL

Figure 42 — Structure of the PSL_REQ

13.3.3.1.1 Definition of the PSL_REQ bytes

CMD0: Shall be set to (D4).

CMD1: PSL_REQ

The PSL_REQ byte shall specify the command Parameter Selection for the Initiator device. The value of PSL_REQ shall be (04).

Byte 0: DID

The DID shall be similar to the DID defined during ATR or WUP.

Byte 1: BRS

The BRS byte shall specify the selected bit rates for Initiator and Target device.

bit 7	bit 6	bit 5	bit 4	bit 3	bit 2	bit 1	bit 0
ZERO	ZERO	DSI	DSI	DSI	DRI	DRI	DRI

Figure 43 — Coding of the BRS byte

- bit 7 and bit 6: Shall be set to ZERO.
- bit 5 to bit 3: Bit duration of Initiator to Target.
- bit 2 to bit 0: Bit duration of Target to Initiator.

Table 12 — Coding of DRI and DSI

DRI and DSI	Bit Rate
000	20 Mbps
001	40 Mbps
010	80 Mbps
011	160 Mbps
100	RFU
101	RFU
110	RFU
111	RFU

Byte 2: FSL

The FSL byte defines the maximum value for the Frame Length.

bit 7	bit 6	bit 5	bit 4	bit 3	bit 2	bit 1	bit 0
ZERO	ZERO	ZERO	ZERO	ZERO	ZERO	LR	LR

Figure 44 — Coding of FSL bytes

- bit 7 to bit 2: Shall be set to all ZERO.
- bit 1 and bit 0: Length Reduction value.

Table 13 — Definition of LR

LR	LEN _{MAX}
00	Only Byte 0 to Byte 255 is valid in the Transport Data
01	Only Byte 0 to Byte 1023 is valid in the Transport Data
10	Only Byte 0 to Byte 4095 is valid in the Transport Data
11	Only Byte 0 to Byte 65535 is valid in the Transport Data

13.3.3.2 Parameter Selection Response (PSL_RES)

The definition of the frame structure of PSL_RES shall be as follows.

CMD0	CMD1	Byte 0
(D5)	(05)	DID

Figure 45 — Structure of PSL_RES

The target shall send the PSL_RES within 1000 ms.

13.3.3.2.1 Definition of the PSL_RES bytes

CMD0: Shall be set to (D5).

CMD1: PSL_RES

The PSL_RES byte shall specify the command Parameter Selection response for the Target device. The value of PSL_RES shall be (05).

Byte 0: DID

The DID shall be the same as the DID defined during ATR or WUP.

13.3.3.3 Handling of PSL_REQ and PSL_RES

13.3.3.3.1 Initiator rules

The Initiator may change protocol parameters by sending the PSL_REQ to the Target. After reception of a valid PSL_RES, the Initiator

- shall change the framing to the format, which is defined in 13.1 and
- shall continue with operation.

In any other case the Initiator may retransmit the PSL_REQ before it shall use the deactivation sequence as defined in 13.5.

13.3.3.3.2 Target rules

When the Target has received a ATR_REQ, sent its ATR RES and

a) receives a valid PSL_REQ, the Target

- shall send its PSL_RES,
- shall disable the PSL_REQ (stop responding to received PSL_REQ),
- shall change all parameters to the defined values, which are specified in 13.3.3 and
- shall remain in receive mode.

b) receives an invalid frame, the Target

- shall ignore the block,
- shall disable the PSL_REQ (stop responding to received PSL_REQ),
- shall remain with the current framing and
- shall remain in receive mode.

c) receives a valid frame, except a PSL_REQ, the Target

- shall disable the PSL_REQ (stop responding to received PSL_REQ),
- shall remain with the current framing and
- shall continue operation.

13.4 Data Exchange Protocol

13.4.1 Data Exchange Protocol Request and Response

13.4.1.1 Data Exchange Protocol Request (DEP_REQ) and Response (DEP_RES)

The protocol shall be half-duplex protocol supporting block oriented data transmission with error handling. For data, which does not fit in one frame a chaining mechanism is defined. Format of the protocol frame shall be as follows:

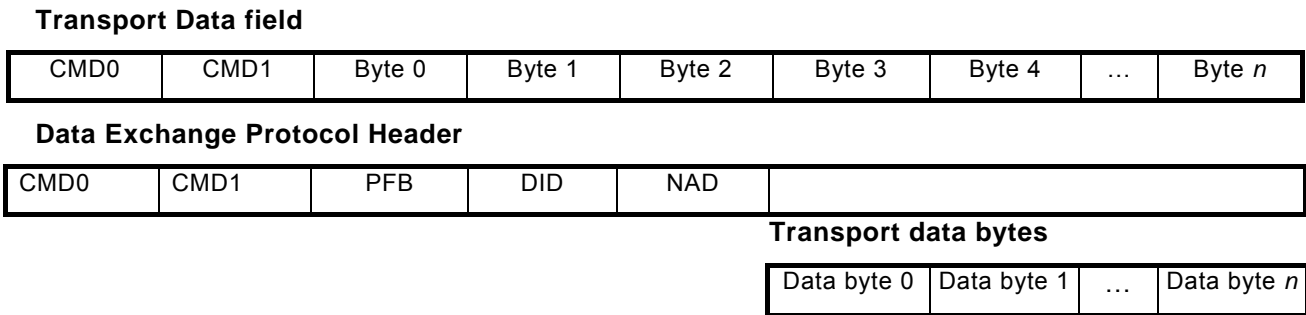

Figure 46 — Definition of the protocol frames

In information interchange, the content of the payload of the Transport Data Field requires agreement between the interchanging parties.

13.4.1.1.1 Definition of the Data Exchange Protocol Header bytes

CMD0:

If the CMD1 is DEP_REQ then the CMD0 shall be set to (D4).

If the CMD1 is DEP_RES then the CMD0 shall be set to (D5).

CMD1: DEP_REQ

The DEP_REQ bytes specify the command for the data exchange protocol for the Initiator device. The value of the DEP_REQ shall be (06).

CMD1: DEP_RES

The DEP_RES bytes specify the command for data exchange for the Target device. The value of the DEP_RES shall be (07).

Byte 0: PFB

The PFB byte shall contain bits to control the data transmission and error recovery. The PFB byte is used to convey the information required controlling the transmission. The data exchange protocol defines three fundamental types of PDU's:

- Information PDU's to convey information for the application layer.
- NFC-SEC PDUs to convey protected information for the application layer.
- Acknowledge PDU's to convey positive or negative acknowledgements. An Acknowledge PDU never contains a data field. The acknowledgement relates to the last received block.

- Supervisory PDU's to exchange control information between the Initiator and the Target. Two types of supervisory PDU's are defined.
 - Timeout extensions containing a 1 byte long data field.
 - Attention containing no data field.

The coding of PFB depends on its type and is defined in the following definitions.

Table 14 — Coding of the PFB bits 7 to 5

bit 7	bit 6	bit 5	PFB
0	0	0	Information PDU
0	0	1	NFC-SEC PDU
0	1	0	Acknowledge PDU
1	0	0	Supervisory PDU
Other settings are RFU			

Definition of the Information PDU:

bit 7	bit 6	bit 5	bit 4	bit 3	bit 2	bit 1	bit 0
ZERO	ZERO	ZERO	MI	NAD	DID	PNI	PNI

Figure 47 — Coding of the information PDU

- bit 7 to bit 5: Shall be set to all ZEROs.
- bit 4: If bit set to ONE then it indicates Multiple Information chaining activated.
- bit 3: If bit set to ONE then it indicates NAD available.
- bit 2: If bit set to ONE then it indicates DID available.
- bit 1 and bit 0: PNI packet number information.

The Packet Number Information (PNI) counts the number of packet send by the Initiator to the Target and vice versa starting by 0. These bytes are used for error detection during the protocol handling.

Definition of the NFC-SEC PDU:

bit 7	bit 6	bit 5	bit 4	bit 3	bit 2	bit 1	bit 0
ZERO	ZERO	ONE	MI	NAD	DID	PNI	PNI

Figure 48 — Coding of the NFC-SEC PDU

- bit 7 to bit 6: Shall be set to all ZEROs. The Target shall ignore it.
- Bit 5: Shall be set to ONE.
- bit 4: If bit set to ONE then it indicates Multiple Information chaining activated.
- bit 3: If bit set to ONE then it indicates NAD available.
- bit 2: If bit set to ONE then it indicates DID available.

- bit 1 and bit 0: PNI packet number information.

The Packet Number Information (PNI) counts the number of packets sent by the Initiator to the Target and vice versa starting at 0. These bytes are used for error detection during the protocol handling.

Definition of Acknowledge PDU:

bit 7	bit 6	bit 5	bit 4	bit 3	bit 2	bit 1	bit 0
ZERO	ONE	ZERO	Acknowledge	NAD	DID	PNI	PNI

Figure 49 — Coding of the Acknowledge PDU

- bit 7: Shall be set to ZERO.
- bit 6: Shall be set to ONE.
- bit 5: Shall be set to ZERO.
- bit 4: If bit set to ONE then it indicates NACK, otherwise ACK.
- bit 3: If bit set to ONE then it indicates NAD available.
- bit 2: If bit set to ONE then it indicates DID available.
- bit 1 and b0: PNI packet number.

Definition of the Supervisory PDU (Attention-Target Present, Timeout extensions):

bit 7	bit 6	bit 5	bit 4	bit 3	bit 2	bit 1	bit 0
ONE	ZERO	ZERO	Attention/ Timeout	NAD	DID	ZERO	ZERO

Figure 50 — Coding of the supervisory PDU

- bit 7: Shall be set to ONE.
- bit 6 and bit 5: shall be set to ZERO.
- bit 4: If ATTENTION then set to ZERO. If TIME-OUT_EXTENTION then set to ONE.
- bit 3: If bit set to ONE then it indicates NAD available.
- bit 2: If bit set to ONE then it indicates DID available.
- bit 1 and b0: Shall be set to ZERO.

Byte 1: DID

The DID byte shall be the same as defined during activation of the protocol.

Byte 2: NAD

The NAD byte is reserved to build up and address different logical connections on both the Initiator and the Target device. Bit 7 to bit 4 code the logical address of the Initiator, bits 3 to 0 code the logical address of the Target. The following definitions shall apply for the usage of the NAD.

- The NAD shall only be used for the data exchange protocol.

- When the Initiator uses an NAD, the Target shall also use an NAD.
- If MI bit is set, the NAD shall only be transmitted in the first frame.
- The Initiator shall never use the NAD to address two different Targets.

Byte 3 to Byte n: User data bytes

The data field shall contain the transported data and is optional. When present, it conveys either application data or status information. The length of the data field is calculated by subtracting the mandatory and optional send bytes of the data exchange transport header from the length byte and additionally subtracting one.

13.4.1.2 Handling of Pdu number information

13.4.1.2.1 Initiator rules

The PNI of the Initiator shall be initialized for each Target with all ZEROS.

When an Information, NFC-SEC or Acknowledge PDU with an equal PNI is received, the Initiator shall increment the current PNI for that Target before optionally sending a new frame.

13.4.1.2.2 Target rules

The PNI of the Target shall be initialized with all ZEROS.

When an information, NFC-SEC or Acknowledge PDU with an equal PNI was received the Target shall send its response with this PNI and shall increment the PNI afterwards.

13.4.1.3 Handling of Blocks

13.4.1.3.1 General rules

The first PDU shall be sent by the Initiator.

When an Information or NFC-SEC PDU indicating more information is received the PDU shall be acknowledged by an Acknowledge PDU (ACK).

Supervisory PDUs are only used in pairs. A Supervisory Request shall always be followed by a Supervisory Response.

13.4.1.3.2 Initiator rules

When an invalid PDU is received an Acknowledge PDU (NACK) shall be sent (except in the case of DSL or RLS).

When a timeout occurs, an attention command shall be sent (except a NACK has been sent before).

When a timeout occurs and a NACK has been sent before, the NACK shall be retransmitted.

When an Acknowledge PDU is received, if its PDU number is equal to the current PNI of the Initiator, the chaining shall be continued.

If the DSL_REQ is not answered by a valid DSL_RES the DSL_REQ may be retransmitted or the Target command ignored.

13.4.1.3.3 Target rules

The Target is allowed to send a Supervisory PDU (RTO) instead of an Information PDU.

When a, information or NFC-SEC PDU not containing chaining is received it shall be acknowledged by an information or NFC-SEC PDU.

When an Acknowledge PDU (NACK) is received, if the PNI is equal to the PNI of the previous sent PDU, the previous block shall be re-transmitted.

When an erroneous PDU is received the Target shall not answer but stay in same State.

When a Supervisory PDU coding an attention command is received, the Target shall respond sending a supervisory attention PDU response.

13.4.2 Response timeout extension

The response timeout extension shall only be used by the Target. When a Target needs more time to process the received block from the Initiator than defined in RWT, it shall use a supervisory PDU using response timeout extension request. A response timeout extension request contains 1 byte long data field. The definition of the byte is shown in Figure 51.

Bit 7	Bit 6	bit 5	Bit 4	bit 3	bit 2	bit 1	bit 0
ZERO	ZERO	RTOX	RTOX	RTOX	RTOX	RTOX	RTOX

Figure 51 — Coding of Response timeout extension byte

- bit 7 and bit 6: Shall be set to ZERO.
- bit 5 to bit 0: RTOX value.

For RTOX the values 0 and 60 to 63 are RFU. For all other values the intermediate RWT_{INT} shall be calculated by the following formula:

$$RWT_{INT} = RWT \times RTOX$$

The RWT_{INT} starts after the Initiator has sent its RTOX response to the Target. In case RWT_{INT} exceeds RWT_{MAX} , RWT_{MAX} shall be used. The RWT_{INT} is valid until the next frame has been received by the Initiator.

13.4.3 Attention – Target present

The Initiator shall send the attention command to the Target to ensure the Target is still in field for passive mode or to be able to detect a Target loss during multi-activation. This command shall not change the current State of the Target.

The Target shall respond to a valid Attention Request sending an attention command containing the identical data field to the Initiator.

If the Target receives an incorrect PDU it shall not respond and shall stay in the same State.

13.4.4 Protocol operation

After the activation sequence the Target shall wait for a block as only the Initiator has the right to send. After sending a block, the Initiator shall switch to receive mode and wait for a block before switching back to transmit mode. The Target may transmit blocks only in response to received blocks. After responding, the Target shall return to the receive mode.

The Initiator shall not initiate a new pair of Request/Response until the current pair of Request/Response has been completed or if the frame waiting time is exceeded without response.

13.4.5 Multi Activation

The Multi-Activation feature allows the Initiator to hold several Targets active simultaneously. It allows switching directly between several Targets without needing additional time for deactivation of a Target and activation of another Target.

For an example of Multi-Activation see Table 15. The Initiator needs to handle a separate package number information for each activated Target.

Table 15 — Multi Activation

Initiator Action	Status Target 1	Status Target 2	Status Target 3
Choose active mode			
Activate Target 1 with DID=1	Selected (1)	Sense	Sense
Any communication with DID=1	Selected (1)	Sense	Sense
...			
Activate Target 2 with DID=2	Selected (1)	Selected (2)	Sense
Any communication with DID=1,2	Selected (1)	Selected (2)	Sense
...			
Activate Target 3 with DID=3	Selected (1)	Selected (2)	Selected (3)
Any communication with DID=1,2,3	Selected (1)	Selected (2)	Selected (3)
...			
Deactivation Sequence with DID=1	Sleep	Selected (2)	Selected (3)
Any communication with DID=2,3	Sleep	Selected (2)	Selected (3)
...			
Deactivation Sequence with DID=2	Sleep	Sleep	Selected (3)
Any communication with DID=3	Sleep	Sleep	Selected (3)
...			
Deactivation Sequence with DID=3	Sleep	Sleep	Sleep
...			

13.4.6 More information (Chaining)

The chaining feature allows the Initiator or Target to transmit information that does not fit in a single block, by dividing the information into several blocks. Each of those blocks shall have a length less than or equal to the maximum frame size (LEN_{MAX}).

The chaining bit in the PFB of a protocol frame controls the chaining of frames. Each frame with the chaining bit set shall be acknowledged by an ACK PDU.

The chaining feature is shown in Figure 52 using a 16 bytes long string transmitted in three blocks.

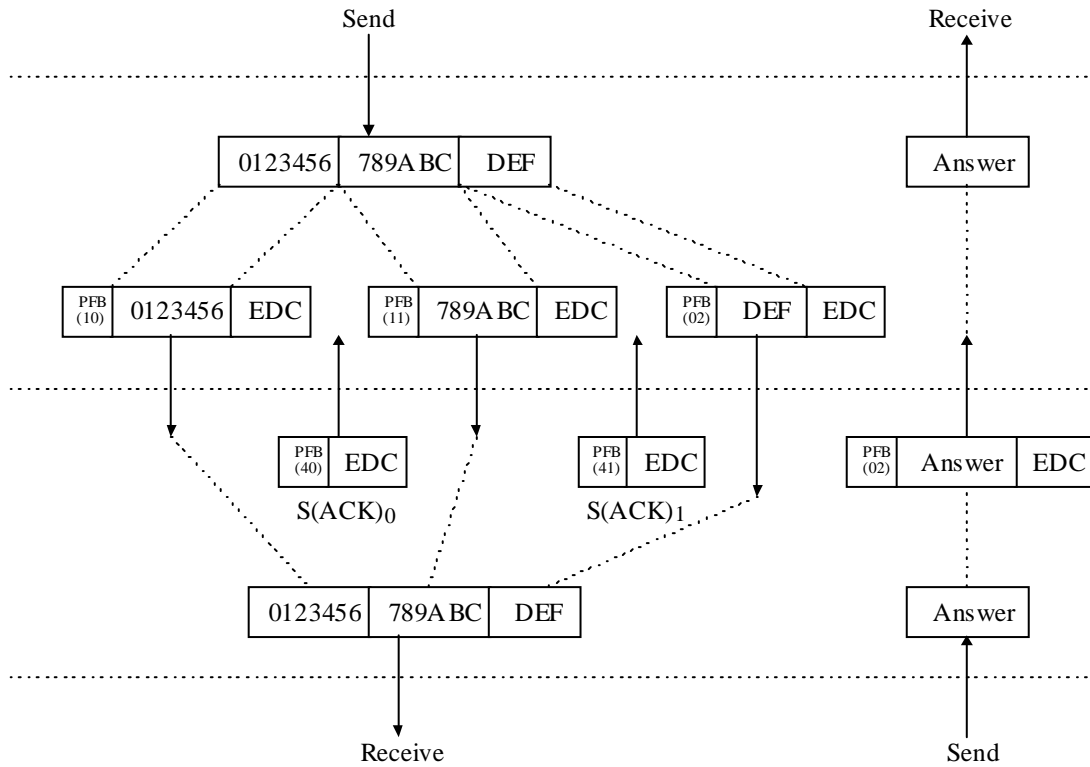

Figure 52 — More Information (Chaining)

13.5 Deactivation of the protocol

When the protocol is activated (see 14.5), the Initiator may apply a deactivation of the data exchange protocol. After successful deactivation Initiator and Target shall stay in the initially chosen mode, but the Initiator may choose one of the defined bit rates for reactivation.

After successful deactivation the Target shall not respond to subsequent ATR_REQ commands.

The RLS_REQ command shall switch the Target back to its power-on reset condition as exists at the start of initialisation and device detection. See 11.3. In this state, the Target shall answer to all initial communication schemes.

13.5.1 Deselect Request and Response command

13.5.1.1 Deselect request (DSL_REQ)

This Clause defines the deselect command DSL_REQ. The DSL_REQ is sent from Initiator to the Target.

CMD0	CMD1	Byte 0
(D4)	(08)	DID

Figure 53 — Structure of the DSL_REQ

13.5.1.1.1 Definition of DSL_REQ bytes

CMD0: Shall be set to (D4).

CMD1: DSL_REQ

The DSL_REQ byte specifies the command deselect for the Initiator device. The value of DSL_REQ shall be (08).

Byte 0: DID

The DID shall be the same as defined during ATR or WUP commands.

13.5.1.2 Deselect response (DSL_RES)

This Clause defines the Deselect Response command DSL_RES. The DSL_RES is the response to the DSL_REQ and is sent from the Target to the Initiator.

CMD0	CMD1	Byte 0
(D5)	(09)	DID

Figure 54 — Structure of the DSL_RES

13.5.1.2.1 Definition of Deselect Response bytes

CMD0: Shall be set to (D5).

CMD1: DSL_RES

The DSL_RES byte specifies the command deselect response for the Target device. The value of DSL_RES shall be (09).

Byte 0: DID

The DID shall be the same as in DSL_REQ.

13.5.1.3 Handling of DSL_REQ and DSL_RES

13.5.1.3.1 Initiator rules

When the Initiator has sent a DSL_REQ and received a valid DSL_RES, the Target has been successfully halted. The DID assigned to the Target has been released.

13.5.1.3.2 Target rules

When the Target has received a DSL_REQ and sent its DSL_RES, the Target

- shall stay in initially chosen mode,
- shall remain in receive mode until a valid ALL_REQ is received in Passive communication mode or a WUP_REQ is received in active communication mode.

13.5.2 Release Request and Response commands

13.5.2.1 Release Request (RLS_REQ)

This Clause defines the release command RLS_REQ. The RLS_REQ is sent from the Initiator to the Target.

CMD0	CMD1	Byte 0
(D4)	(0A)	DID

Figure 55 — Structure of RLS_REQ

13.5.2.1.1 Definition of RLS_REQ bytes

CMD0: Shall be set to (D4).

CMD1: RLS_REQ

The RLS_REQ bytes specify the command release for the Initiator device. The value of the RLS_REQ bytes shall be (0A).

Byte 0: DID

The DID shall be the same as defined in ATR or WUP commands.

13.5.2.2 Release response RLS_RES

This Clause defines the answer to release command the release response command RLS_RES. The RLS_RES is the response to the RLS_REQ sent from the Target to the Initiator.

CMD0	CMD1	Byte 0
(D5)	(0B)	DID

Figure 56 — Structure of RLS_RES

13.5.2.2.1 Definition of RLS_RES bytes

CMD0: Shall be set to (D5).

CMD1: RLS_RES

The RLS_RES bytes specify the command release for the Target device. The value of the RLS_RES bytes shall be (0B).

Byte 0: DID

The DID shall be the same as defined in RLS_REQ command.

13.5.2.3 Handling of RLS_REQ and RLS_RES

13.5.2.3.1 Initiator rules

When the Initiator has sent a RLS_REQ and received a valid RLS_RES, the Target has been successfully released. The Initiator may return to its initial state.

13.5.2.3.2 Target rules

When the Target has received a RLS_REQ and sent its RLS_RES, the Target shall return to its initial state.

14 Direct Addressing Protocol

In Direct Addressing Protocol, an Initiator may write and read data directly to memory in a Target device.

CMD_EX in the HEADER is used to specify the starting address of a transaction, and number of bytes to be transferred.

CMD3 in the HEADER is used to specify the type of transaction being undertaken.

For Targets, if Direct Addressing Protocol is supported, then the Read command shall be supported; all other commands are optional.

Initiators shall support all commands specified in 14.

The Direct Addressing Protocol capabilities of a Target shall be encoded as described in 14.11.

14.1 Read (CMD3=0x00)

Purpose: Read one or more bytes from target starting from location 'Addr'.

14.1.1 Initiator command

	SOF		HEADER					
	Preamble	SYNC 16 bit	CHAN 4 bit	SOC 12 bit	CMD3 8 bit	CMD_EX 48 bit		CRCH 32 bit
						ADDR 32 bit	LEN 16 bit	
Value	See initiator standard frame format				0x00	Addr	N bytes	CRC

Figure 57 — Initiator to target 'Read' frame format

Preamble is PRE0, PRE1 for Passive communication mode command, PRE2 for Active communication mode

- CMD3: This value shall be 0x00.
- ADDR: Target's start address from which data is to be read from.
- LEN: Length N of data to be read in byte units (8 bits).
- CRCH: CRC of CHAN, SOC, CMD3, ADDR and LEN fields concatenated together.

14.1.2 Target response

	Preamble	SYNC 16 bit	CMD3 8 bit	PLDT (N x 8 bit)	CRCT 32 bit
Value	See target standard frame format		0x00	Data	CRC

Figure 58 — Read from target *response* frame format

- CMD3: Response field. This value shall be 0x00.
- PLDT: Payload. This field contains the requested data of length N, with LSB first.

- CRCT: CRC of CMD3 and PLDT fields.

14.2 Write (CMD3=0x01)

Purpose: Write one or more bytes to target starting from location 'addr'. Support for this command in a Target is indicated by the MEM_DATA parameter as described in 15.4.14.

14.2.1 Initiator command

	SOF		HEADER					PAYLOAD		
	Preamble	SYNC 16 bit	CHAN 4 bit	SOC 12 bit	CMD3 8 bit	CMD_EX 48 bit		CRCH 32 bit	PLD (N x 8 bit)	CRCP 32 bit
						ADDR 32 bit	LEN 16 bit			
Value	See initiator standard frame format				0x01	Addr	N bytes	CRC	Data	CRC

Figure 59 — Initiator to target 'Write' frame format

Preamble is PRE0, PRE1 for Passive communication mode, PRE2 for Active communication mode

- CMD3: This value shall be 0x01.
- ADDR: Target's start address Addr, to which data is to be written.
- LEN: Length (N) of data to write in bytes units (8 bits).
- CRCH: CRC of CHAN,SOC,CMD3,ADDR,LEN fields.
- PLD: Data to write of length (N) bytes, with LSB first.
- CRCP: CRC of PLD field.

14.2.2 Target response

The Target shall respond with an Acknowledgement frame (ACK) if the data is successfully written to memory. See 14.9.

The Target shall respond with a Negative Acknowledgement frame (NACK) if the data is not successfully written to memory. See 14.10.

14.3 WriteSync (CMD3=0x02)

Purpose: Write one or more bytes to target starting from location 'addr', using SyncFlash algorithm. Support for this command in a Target is indicated by the MEM_DATA parameter as described in 15.4.14.

14.3.1 Initiator command

	SOF		HEADER					PAYLOAD										
	Preamble	SYNC 16 bit	CHAN 4 bit	SOC 12 bit	CMD3 8 bit	CMD_EX		CRCH 32 bit	PLD1 8 bit	CRC1 32 bit	PAD P bit	PLD2 8 bit	CRC2 32 bit	PAD P bit	PLDn 8 bit	CRCn 32 bit	PAD P bit
						ADDR 32 bit	LEN 16 bit											
Value	See initiator standard frame format			0x02	Addr	N bytes	CRC	Data	CRC	x	Data1	CRC1	x		Datan	CRCn	x	

Figure 60 — Initiator to target 'WriteSync' frame format

Preamble is PRE0, PRE1 for Passive communication mode, PRE2 for Active communication mode

- CMD3: This value shall be 0x02.
- ADDR: Target's start address, Addr, to which data is to be written.
- LEN: Length (N) of data to write in bytes units (8 bits).
- CRCH: CRC of CHAN, SOC, CMD3, ADDR, and LEN fields concatenated together.
- PLD1: 1st (LSB) data byte of payload.
- CRC1: CRC of 1st data byte.
- PLD2: 2nd data byte of payload.
- CRC2: CRC of 2nd data byte.
- PLDn: nth data byte of payload.
- CRCn: CRC of nth data byte.
- PAD: Padding. The size of this field shall be determined by the following formula:
 Size, P = (STRT*PDSTRT + PDDATA + CROSS*PDRX + END*PDEND.) x 8 bits.
 - PDSTRT, PDDATA, PDRX, PDEND shall be obtained from the Target Common Control Parameters (TCCP), see 15.4.
 - STRT: This shall be 1 for the 1st byte and shall be 0 for subsequent bytes.
 - CROSS: This shall be 1 if the address crosses a row boundary and shall be 0 otherwise. This field shall be set to 0 if the physical memory architecture is not of row configuration type.

The value of CROSS is determined by the following formula:

$$\text{CROSS} = 1$$

if Address written = (N x RowSz)+1 (N is an integer)

else CROSS =0

The Row Size shall be obtained from the Row Size parameter (see 15.4.4).

- END: This shall be 1 for the last byte and shall be 0 for all other bytes.

The value of the PAD data is not defined, and is at the implementer's discretion.

14.3.2 Target response

The Target shall respond with an Acknowledgement frame (ACK) if the data is successfully written to memory. See 14.9.

The Target shall respond with a Negative Acknowledgement frame (NACK) if the data is not successfully written to memory. See 14.10.

14.4 PageErase (CMD3=0x03)

Purpose: Initialise one page of target's memory. Support for this command in a Target is indicated by the MEM_DATA parameter as described in 15.4.14.

This operation only applies to target with Flash/EEPROM based memory. This operation shall have no effect on "RAM type" memory, use 'Write' operation to overwrite contents for "RAM type" memory. The initialised value may be logical '1' or logical '0' and is dependent on the target memory technology.

14.4.1 Initiator command

	SOF		HEADER					PAYLOAD	
	Preamble	SYNC	CHAN	SOC	CMD3	CMD_EX		CRCH	PAD
		16 bit				4 bit	12 bit		8 bit
Value	See initiator standard frame format			0x03	Addr	0x0032	CRC	x	

Figure 61 — Initiator to target 'PageErase' frame format

Preamble is PRE0, PRE1 for Passive communication mode, PRE2 for Active communication mode

- CMD3: This value shall be 0x03.
- ADDR: Target's page to erase. The target shall erase the entire page that contains this address. For example, if the target page size is 256 bytes, erasing address 0x102H and 0x14FH shall mean the same thing: i.e. the target shall erase page 1.
- ID: This value shall be 0x0032.
- CRCH: CRC of CHAN, SOC, CMD3, ADDR, and LEN fields concatenated together.
- PAD: End-of-frame padding. This shall be PDPERASE x 8 bits (see 15.4.12). The target shall ignore the contents of this field. The value of the PAD data is not defined, and is at the implementer's discretion.

14.4.2 Target response

The Target shall respond with an Acknowledgement frame (ACK) if the data is successfully written to memory. See 14.9.

The Target shall respond with a Negative Acknowledgement frame (NACK) if the data is not successfully written to memory. See 14.10.

14.5 MassErase (CMD3=0x08)

Purpose: Initialise entire target's memory. Support for this command in a Target is indicated by the MEM_DATA parameter as described in 15.4.14.

This operation only applies to targets with Flash/EEPROM based memory. This operation shall have no effect on "RAM type" memory, use 'Write' operation to overwrite contents for "RAM type" memory. The initialised value may be logical '1' or logical '0' and is dependent on the target memory technology.

14.5.1 Initiator command

	SOF		HEADER				PAYLOAD
	Preamble	SYNC 16 bit	CHAN 4 bit	SOC 12 bit	CMD3 8 bit	CMD_EX CRCH 32 bit	PAD PDMERASE x 8 bit
Value	See initiator standard frame format				0x08	0x0000025F0032 CRC	x

Figure 62 — Initiator to target 'MassErase' frame format

Preamble is PRE0, PRE1 for Passive communication mode, PRE2 for Active communication mode

- CMD3: This field shall be of value 0x08H.
- MASSERASEID: 0x0000025F0032.
- CRCH: CRC of CHAN, SOC, CMD3, and CMD_EX fields concatenated together.
- PAD: End of frame padding. This shall be PDMERASE x 8 bits (see 15.4.13). The target shall ignore the contents of this field. The value of the PAD data is not defined, and is at the implementer's discretion.

14.5.2 Target response

The Target shall respond with an Acknowledgement frame (ACK) if the data is successfully written to memory. See 14.9.

The Target shall respond with a Negative Acknowledgement frame (NACK) if the data is not successfully written to memory. See 14.10.

14.6 Authenticate (CMD3=0x04)

Purpose: Authenticate target's (k) key, where (k) is 0 to 15. Support for this command in a Target is indicated by the MEM_DATA parameter as described in 15.4.14.

The target shall respond with a 180 bit SHA-1 message digest of the augmented challenge and secret key (k).

14.6.1 Initiator command

	SOF		HEADER							PAYLOAD		
	Preamble	SYNC 16 bit	CHAN 4 bit	SOC 12 bit	CMD3 8 bit	CMD_EX 48 bit				CRCH 32 bit	CHA 216 bit	PAD
						AID0 23 bit	KEY 4 bit	REV 5 bit	AID1 16 bit			
Value	See initiator standard frame format				0x04	0x1	k	0x0	0x20	CRC	#	x

Figure 63 — Initiator to Target broadcast ‘Authenticate’ frame

Preamble is PRE0, PRE1 for Passive communication mode, PRE2 for Active communication mode

NOTE # denotes operational dependent values.

- CMD3: This value shall be 0x04.
- AID0: Authentication ID0. This field shall be 23 bit. The value shall be 0x1.
- KEY: Authentication Key. This field indicates which key to authenticate and shall be 4 bits.
- REV: This field is reserved and shall be 0x0.
- AID1: Authentication ID1. This field shall be 16 bit. The value shall be 0x20.
- CRCH: CRC of CHAN, SOC, CMD3, and CMD_EX fields concatenated together.
- CHA: Challenge. This field shall be 216 bit. The target shall use this field as a challenge key.
- PAD: End of frame padding. This field shall be 8 x AUTH_PAD (see 0) bits long. The target shall ignore the contents of this field. The value of the PAD data is not defined, and is at the implementer’s discretion.

14.6.2 Target response

	Preamble	SYNC 16 bit	CMD3 8 bit	DIGST (180 bit)
Value	See target standard frame format		0x05	Data

Figure 64 — Authenticate response frame format

- CMD3: Response field. This value shall be 0x05.
- DIGST: 180 bit SHA1 message digest of augmented challenge and secret key (k).

14.7 ReportID (CMD3=0xFE)

Purpose: Retrieve target’s ChannelID and SocketID value on channel (c). This frame is usually used for target enumeration and isolation.

14.7.1 Initiator Command

	SOF		HEADER					
	Preamble	SYNC 16 bits	CHAN 4 bits	SOCK 12 bit	CMD3 8 bits	CMD_EX 48 bit		CRCH 32 bit
						ADDR 32 bit	LEN 16 bit	
Value	See initiator standard frame format		chan	x	0xFE	0x00000100	0x2	CRC

Figure 65 — Initiator to Target broadcast 'ReportID' frame

Preamble is PRE0, PRE1 for Passive communication mode, PRE2 for Active communication mode

- CHAN: Channel number, chan, this frame is applied to. Valid values are 0 through 14. The target shall respond to a 'ReportID' frame if this field matches it own ChannelID field.
- SOCK: This field shall be 12 bit. The target shall ignore this field. The value of the SOCK data is not defined, and is at the implementer's discretion.
- CMD3: This value shall be 0xFE (Report ID opcode).
- ADDR: This value shall be 0x00000100. (ID parameter location).
- LEN: This value shall be 0x02.
- CRCH: CRC of fields CHAN, SOCK, CMD3, ADDR, and LEN concatenated together.

14.7.2 Target Response

	Preamble	SYNC	CMD3	CHAN	SOCK	CRCT
		16 bits	8 bits	4 bits	12 bits	32 bits
Value	See target standard frame format		0xFE	chan	sock	CRC

Figure 66 — ReportID response frame format

- CMD3: This value shall be 0xFE.
- CHAN: This value shall be the target's ChannelID equal to the ID parameter.
- SOCK: This value shall be the target's SocketID equal to the ID parameter.
- CRCT: CRC of fields CMD3, CHAN, and SOCK concatenated together.

14.8 ResetID (CMD3=0xFF)

Purpose: Reset target's ChannelID and SocketID value on channel (c). This frame is usually used for target enumeration and isolation.

14.8.1 Initiator Command

	SOF		HEADER						
	Preamble	SYNC 16 bits	CHAN 4 bits	SOCK 12 bit		CMD3 8 bits	CMD_EX 48 bit		CRCH 32 bit
				8 bit	4 bit		ADDR 32 bit	LEN 16 bit	
Value	See initiator standard frame format		chan	x	N	0xFF	0x00000100	0x0	CRC

Figure 67 — Initiator to Target ‘ResetID’ frame

NOTE 1 Preamble is PRE0, PRE1 for Passive communication mode, PRE2 for Active communication mode

NOTE 2 x denotes any arbitrary values.

- CHAN: Channel number this frame is applied to. Valid values are 0 through 15. Channel 15 shall be the broadcast channel. All targets shall respond to a ‘ResetID’ frame if (c) matches its ChannelID or if (c) is 0xFF (broadcast channel).
- SOCK: The initiator shall specify the number of channels (N) available for this session. The value shall range from 1 through 13, all other values shall be invalid. The target shall ignore the 8 most significant bits.
- CMD3: This value shall be 0xFFH (ResetID opcode).
- ADDR: This value shall be 0x00000100H.
- LEN: This value shall be 0x00H to indicate that no payload data is to follow.
- CRCH: CRC of fields CHAN, SOCK, CMD3, ADDR, and LEN concatenated together.

14.8.2 Target Response

	Preamble	SYNC	CMD3	CHAN	SOCK	CRCT
		16 bits	8 bits	4 bits	12 bits	32 bits
Value	See target standard frame format		0xFE	chan	sock	CRC

Figure 68 — ResetID response frame format

NOTE # denotes operational dependent values.

- CMD3: This value shall be 0xFE (8 bits)
- CHAN: This value shall be the target’s ChannelID equal to the ID parameter.
- SOCK: This value shall be the target’s SocketID equal to the ID parameter.
- CRCT: CRC of fields CMD3, CHAN, and SOCK fields concatenated together.

14.9 Acknowledgement – ACK (CMD3 = 0x06)

	Preamble	SYNC	CMD3 8 bit	CRCT 32 bit
Value	See target standard frame format		0x06	0xA26909D1

Figure 69 — ACK response frame format

14.10 Negative Acknowledgement – NAK (CMD3 = 0x15)

	Preamble	SYNC	CMD3 8 bit	CRCT 32 bit
Value	See target standard frame format		0x15	0xE33bF478

Figure 70 — NACK response frame format

14.11 Device Management

Attributes of a device shall be discovered by reading defined parameters to retrieve the version # of the MSIP-1 specification being supported, the send and receive data rates of the device, and the maximum frame lengths supported.

14.11.1 Attribute Discovery

14.11.1.1 Protocol

This parameter indicates the supported protocols of the device.

The PROTOCOL byte shall be encoded as below:

Bit 0 = 1 if Direct Addressing Protocol is supported when operating as a Target.

Bit 1 = 1 if MSIP-1 Protocol is supported when operating as a Target.

14.11.1.2 VER_PHY

This parameter indicates the version number of the specification supported by this device.

For version 1 of the specification the encoding of VER_PHY is as follows:

Bit 7	Bit 6	Bit 5	Bit 4	Bit 3	Bit 2	Bit 1	Bit 0
0	0	0	0	0	0	0	1

Figure 71 — Coding of the VER_PHY byte

14.11.1.3 BSt, BRt

This parameter indicates the data rates supported by the device when operating as a Target.

The coding of bits is as follows:

bit 7	bit 6	bit 5	bit 4	bit 3	bit 2	bit 1	bit 0
BSt	BSt	BSt	BSt	BRt	BRt	BRt	BRt

Figure 72 — Coding of the BSt, BRt byte

- bit 7: BSt = 160 Mbps sending supported, shall be set to ZERO, RFU
- bit 6: BSt = 80 Mbps sending supported, shall be set to ZERO, RFU
- bit 5: BSt = 40 Mbps sending supported, shall be set to ZERO, RFU
- bit 4: BSt = 20 Mbps sending supported, shall be set to ZERO, RFU
- bit 3: BRt = 160 Mbps receiving supported, shall be set to ZERO, RFU
- bit 2: BRt = 80 Mbps receiving supported, shall be set to ZERO, RFU
- bit 1: BRt = 40 Mbps receiving supported, shall be set to ZERO, RFU
- bit 0: BRt = 20 Mbps receiving supported, shall be set to ZERO, RFU

If the device does not support Direct Addressing Protocol functionality then the BSt, BRt byte is set to 0x00.

14.11.1.4 LRt

This parameter indicates the maximum frame lengths supported by the device when operating as a Target.

The coding of bits shall be as follows:

bit 7	bit 6	bit 5	bit 4	bit 3	bit 2	bit 1	bit 0
ZERO	ZERO	ZERO	ZERO	ZERO	ZERO	LRt	LRt

Figure 73 — Coding of the LRt byte

- bit 7, 6, 5, 4, 3 and 2: Shall be set to ZERO.
- bit 1 and bit 0: Length Reduction value when acting as a Target.

LRt	LEN _{MAX}
00	Only Byte 0 to Byte 255 is valid in the PAYLOAD
01	Only Byte 0 to Byte 1023 is valid in the PAYLOAD
10	Only Byte 0 to Byte 4095 is valid in the PAYLOAD
11	Only Byte 0 to Byte 65535 is valid in the PAYLOAD

Figure 74 — LRt coding for LEN_{MAX}

14.11.2 Parameter Selection

The PSL parameter (15.4.18) is used to instruct the Direct Addressing Protocol device to use selected data rates for sending and receiving data.

Setting this parameter using the WRITE command (see 14.2) is used to execute this parameter selection.

14.11.2.1 Data Rate

The PSL parameter is encoded as follows:

bit 7	bit 6	bit 5	bit 4	bit 3	bit 2	bit 1	bit 0
RFU	RFU	RFU	BRt	BRt	RFU	BSt	BSt

Figure 75 — Coding of the PSL Parameter

- bit 1 and bit 0: Target Sending Data Rate:

BSt	Data Rate
00	10 Mbps
01	20 Mbps
10	40 Mbps
11	80 Mbps

Figure 76 — BSt Data Rate coding

- bit 4 and bit 3: Target Receiving Data Rate:

BRt	Data Rate
00	10 Mbps
01	20 Mbps
10	40 Mbps
11	80 Mbps

Figure 77 — BRt Data Rate coding

- bit 2: Shall be set to ZERO
- bit 7, 6, 5: Shall be set to ZERO.

15 Target Fixed Internal Map

15.1 Map

The addresses in the map below shall identify references to parameter data that describes the capabilities and configuration of the device. Implementation is not required in the form of this map.

Address	Offset 7 (MSB)	Offset 6	Offset 5	Offset 4	Offset 3	Offset 2	Offset 1	Offset 0 (LSB)		
0xFFFFFFFF 0x00000400	R/W Memory									
0x000003FD 0x000003E0	Secret Key 15 (240 bits)								Write only Memory (WOM)	
⋮										
0x0000023D 0x00000220	Secret Key 1 (240 bits)									
0x0000021D 0x00000200	Secret key 0 (240 bits)									
0x00000107 0x00000100	Reserved					PSL Parameter	ID Parameter			TCCP
0x00000037 0x00000030	Reserved	ChkSum2 (Check sum)				AUTH_PAD		MEM_DATA		
0x0000002F 0x00000028	PDMERASE (mass erase padding)		PDPERASE (page erase padding)		PDEND (last byte padding)	PDRX (Row crossing padding)	PDDATA (Data byte padding)	PDSTRT (1 st byte padding)		
0x00000027 0x0000001F	ChkSum1 (Check sum)	Sz (Memory Size)	PgSz (Page Size)	RowSz (Row size)	UsrStrtPg (Start of user's page)	VER_MEM (version)	UTHID (Tag Format ID)			
0x0000001F 0x00000018	ChkSum0 (Check sum)	Reserved	LRI, LRt Max frame length	BSt, BRt Target Data Rates	BSi, BRi Initiator Data Rates	VER_PHY (version)	PROTOCOL Direct Addressing and/or MSIP-1			
0x00000017 0x00000008	PDID									
0x00000007 0x00000000	Reserved									

Figure 78 — Address Map

15.2 Physical Device Identifier (PDID)

This field consists of 128 bits.

The PDID shall be supported in devices supporting Direct Addressing protocol.

The PDID may be read by performing a Read command (14.1) with ADDR = 0x0000008 and LEN = 8.

15.3 Device Common Control Parameters (DCCP)

The Device Common Control Parameters allow for efficient checking of the basic characteristics of the device. See 14.11.1.

The DCCP shall be supported in devices supporting Direct Addressing protocol.

15.4 Target Common Control Parameters (TCCP)

The Target Common Control Parameters allow for quick host checking and control of the target's on a per target basis. The bits in the TCCP are mixed Read/Write and read only. All reserved for future use bits (RFU) shall be read-only and return a value of 0. All writeable bits are set to 0 after power-up or reset. Access to the TCCP is possible at any time.

The TCCP shall be supported in devices supporting the Direct Addressing protocol.

Each parameter may be read by performing a Read command (14.1) with the Read command's ADDR field equal to the Location value indicated in each of the following clauses and with the Read command's LEN field equal to the byte length of the parameter being read.

15.4.1 Universal Target Header Identity (UTHID) – Location 0x00000018

This is a 1-byte field that identifies this memory system as conforming to the MSIP-1 UTH format. This field shall be populated with the value 0x46H.

15.4.2 Universal Target Header Version (VER) – Location 0x00000019

This is a 1-byte field that indicates the version of UTH. Its value shall be 0x01 (version 1.0).

15.4.3 User Start Page (usrStrtPg) – Location 0x0000001A

This is a 1-byte field that specifies the page number of the first usable page in the target's memory.

15.4.4 Row Size (RowSz) – Location 0x0000001B

This is a 1-byte field that specifies the length of the row used in the memory.

The Row Length = 2^{RowSz}

15.4.5 Page Size (PgSz) – Location 0x0000001C

This is a 1-byte field that specifies the page size of the memory technology. This value is expressed as a binary multiple using the following formula:

Absolute size of page (bytes) = 2^{PgSz}

For example: A 256 bytes page size memory technology would have a value of 0x8H as the pageSize. A 2048 bytes page size memory technology would have a value of 0xBH as the pageSize.

If pageSize = 0 then this means that the absolute size of the page is a single byte, indicating that RAM-type memory is used.

15.4.6 size (Sz) – Location 0x0000001D

This is a 1-byte field that specifies the total size of the device. This value is expressed as binary multiples using the following formula

Absolute memory size (bytes) = 2^{Sz}

For example: A 32,768 bytes memory size shall have a value of 0xFH as the size. A 524,288 bytes memory size shall have a value of 0x13H as the size.

15.4.7 ChkSum1– Location 0x0000001E

This is a one’s complement value of, `UsrStartPage`, `PageSize`, `Size`. This checksum ensures these fields are not corrupted. An example of how this value is computed is as follows:

If Offset 14,15,16,17 is given as **0x0AH,0x0BH,0x0CH,0x0DH**, Offset 18,19,20,21 shall be **0xF5H,0xF4H,0xF3H,0xF2H**

15.4.8 PDSTRT– Location 0x00000020

See 14.3.1.

15.4.9 PDDATA– Location 0x00000021

See 14.3.1.

15.4.10 PDRX– Location 0x00000022

See 14.3.1.

15.4.11 PDEND– Location 0x00000023

See 14.3.1.

15.4.12 PDPERASE– Location 0x00000024

See 14.4.1.

15.4.13 PDMERASE– Location 0x00000026

See 14.5.1.

15.4.14 MEM_DATA– Location 0x00000028

The supported capabilities of the memory starting at the address given in `usrStrtPage` and addressable using the Direct Addressing protocol is given by the `MEM_DATA` parameter:

The `MEM_DATA` parameter is encoded as follows:

bit 7	bit 6	bit 5	bit 4	bit 3	bit 2	bit 1	bit 0
RFU	RFU	RFU	AU	ME	PE	Wr1	Wr0

Figure 79 — Coding of the MEM_DATA Parameter

- bit 4: Authentication supported, if bit is set to ONE
- bit 3: Mass Erase supported, if bit is set to ONE
- bit 2: Page Erase supported, if bit is set to ONE
- bit 1 and bit 0: Write Capability:

Wr1,0	Meaning
00	Write is NOT supported
01	Only Write CMD3=0x01 supported
10	Only WriteSync CMD3=0x02 supported
11	Write CMD3=0x01 and WriteSync CMD3=0x02 supported

Figure 80 — Write Capability

15.4.15 AUTH_PAD– Location 0x00000029

16 bit value that defines the number of padding bytes used during the Authenticate command.

15.4.16 ChkSum2– Location 0x0000002B

This is a one's complement value of, PDSTRT, PDDATA, PDRX, PDEND, PDPERASE, MEM_DATA, AUTH_PAD. This checksum ensures these fields are not corrupted.

15.4.17 ID Parameter– Location 0x00000100

See 11.3.

15.4.18 PSL Parameter– Location 0x00000102

See 0.

15.5 Write only Memory (WOM)

This set of key values shall be supported if the device supports Authentication as defined in 14.6.



Annex A (normative)

CRC Calculation

The CRCH, CRCP and CRCT fields are used to detect errors in the HEADER, PLD and PLDT fields respectively. The CRCT field is used to detect errors in the Target frame. CRCH, CRCP and CRCT shall be 32 bit.

The CRC shall be calculated by the following polynomial.

$$G(x) = x^{32} + x^{26} + x^{23} + x^{22} + x^{16} + x^{12} + x^{11} + x^{10} + x^8 + x^7 + x^5 + x^4 + x^2 + x + 1$$

The initial state of the LFSR shall be loaded with logical '1'. Data is shifted in and out as indicated. The resulting CRC value shall be attached to the respective field (ie CRCH, CRCP, CRCT). The most significant byte shall be transmitted first. The most significant bit of each byte shall be transmitted first.

At the receiving side (initiator and target) the incoming CRC bits are clocked into the register. After the LSB bit is clocked, the 32 bit LFSR register should contain all '1's. The 32 bit CRC shall be calculated on all data bits up to, but not including, the first CRC bit.

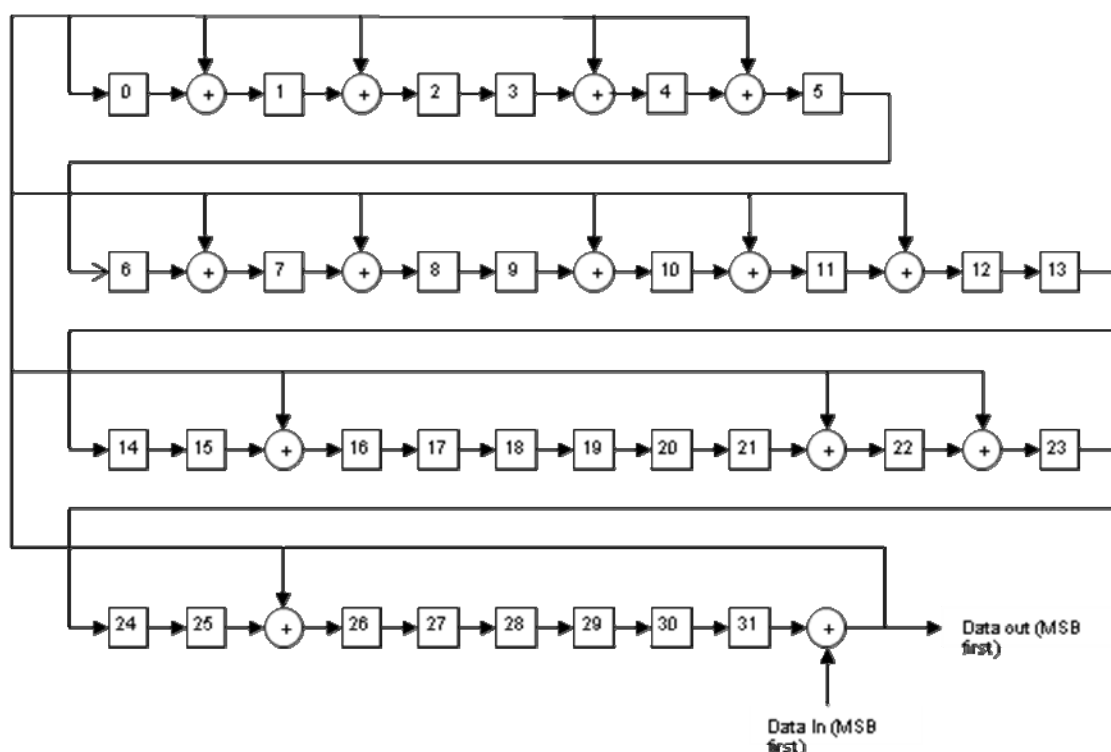

Figure A.1 — The LFSR circuit generating the CRC for Initiator and Target



Annex B (informative)

Authentication

The entity authentication specified herein uses a challenge-response scheme in which an Initiator's knowledge of a secret key is checked through a 2-move protocol using symmetric secret keys. The latter implies that a correct Initiator/Target pair shared the same secret key.

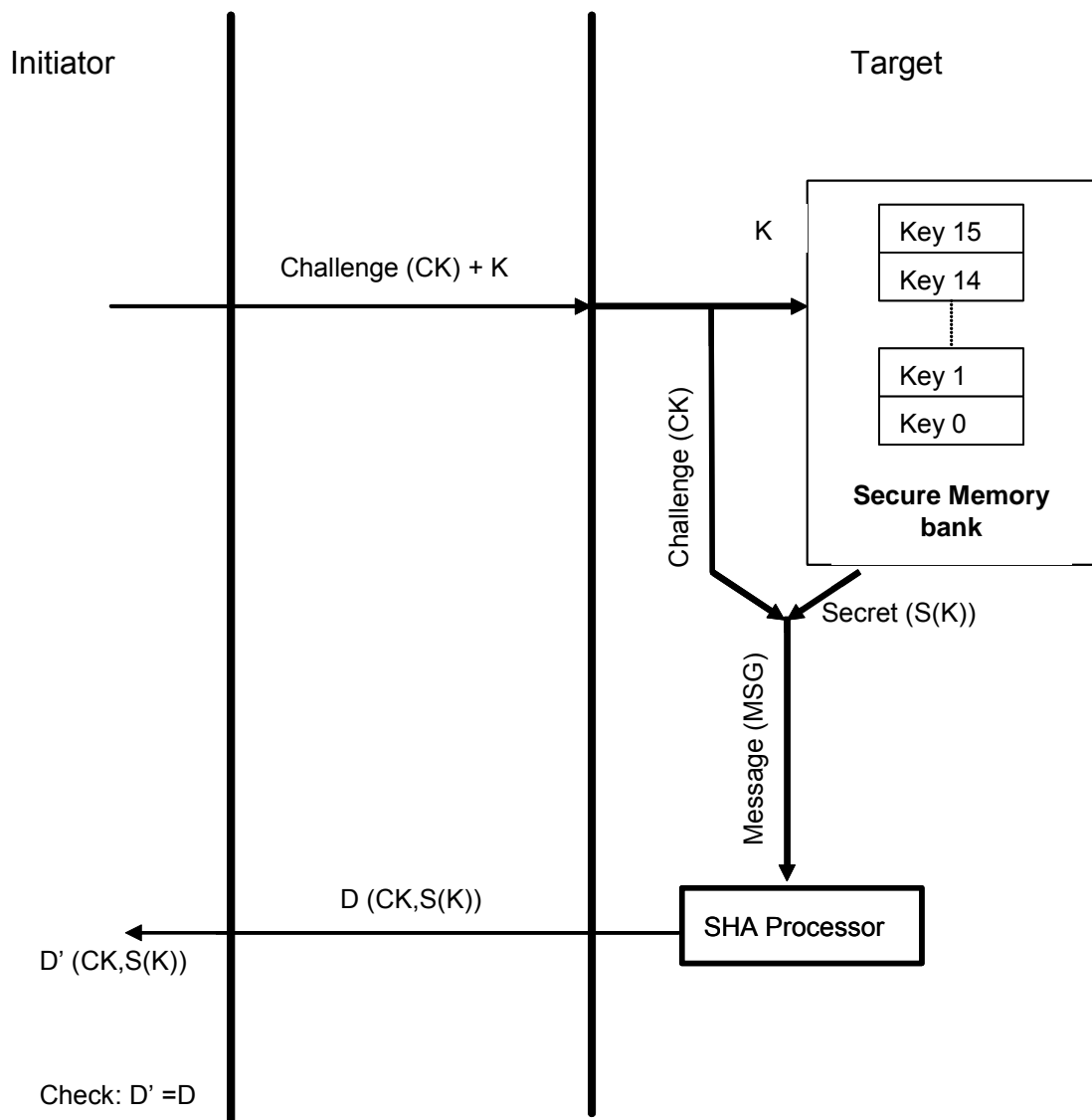

Figure B.1 — Challenge-response for symmetric key systems

In the challenge-response scheme, the initiator challenges the target to authenticate a random input (the Challenge key), denoted by CK, with a 4 bit authentication key (K). K shall be a value between 0 and 15 and shall be used as a pointer to retrieve the secret key S(K) from the Target's secure memory bank. A 480 bit string Message (MSG) consisting of the interleaving bytes Challenge (CK) and Secret S(k) shall be formed see Figure B.2 for the input message (MSG) to the SHA processor.

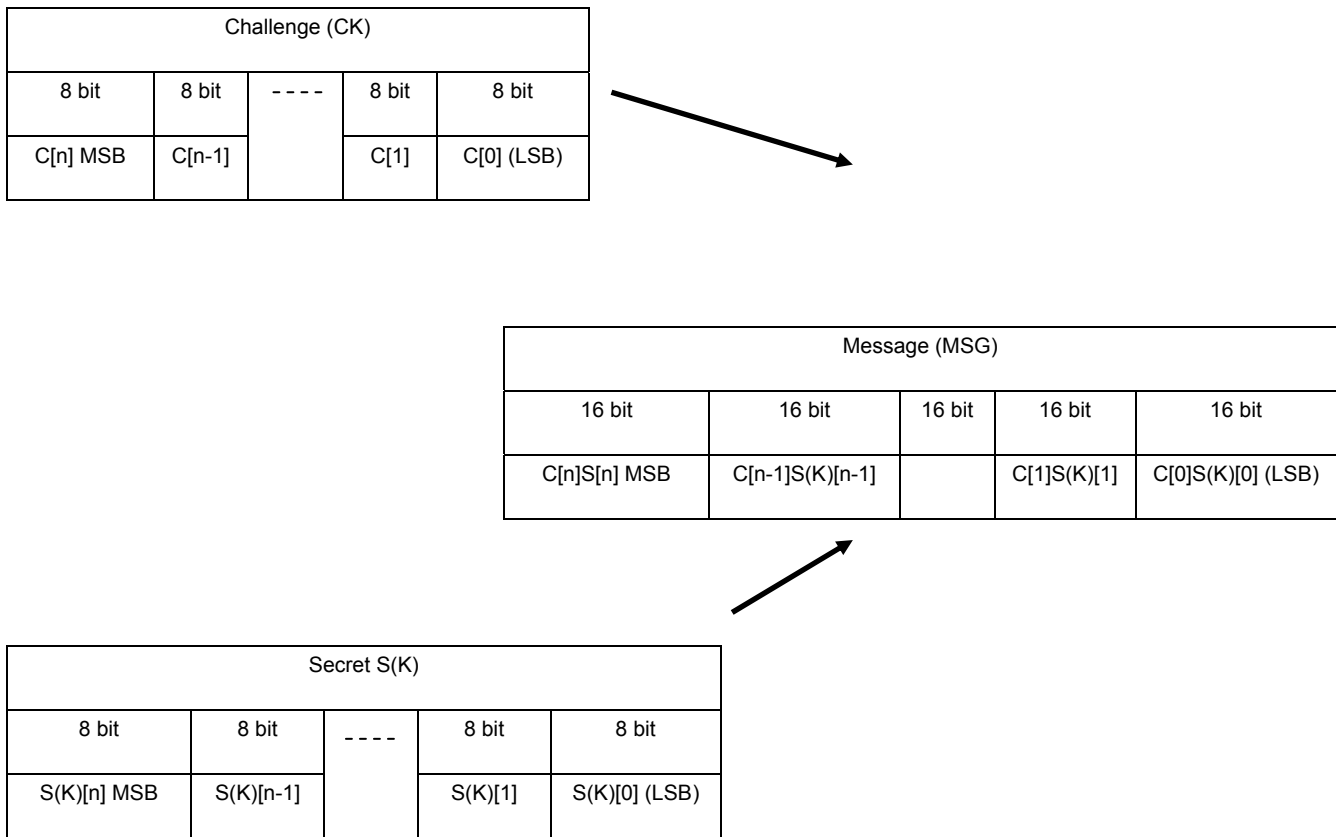

Figure B.2 — SHA processor input message formation

The 480-bit string Message (MSG) shall be digested by the target's authenticator using a SHA-1 (FIPS PUB 180-1) compliant algorithm, producing a 160 bit Digest (D). SHA-1 algorithm is well documented and is freely available. The Digest (D) will be sent back to the initiator. An alternate Digest (D') may be calculated in the initiator using prior knowledge of the secret S(K) using the same technique. Alternatively the alternate Digest (D') may be calculated using another target. The later method is preferred. The targets with matching D=D' implies that they share the same secret.

Annex C **(normative)**

Reference Antennas

This Annex specifies the design and validation of three reference antennas that shall be used to determine the radiated power and received power as specified in this Standard.

The designs specified herein include information sufficient to build the reference antennas. This comprises dimensional information with their required tolerances, and specifications for materials used in their construction. All dimensions are in mm.

Equivalent parts or materials may be substituted for manufacturer-specific items specified in the designs in this Annex.

This Annex also specifies a procedure to measure the reference antennas to ensure their correct operation.

C.1 Reference Antenna #1

C.1.1 Design Information

Figure C.1 illustrates the PCB layout of the Reference Antenna #1 and specifies the PCB material and the circuit components used.

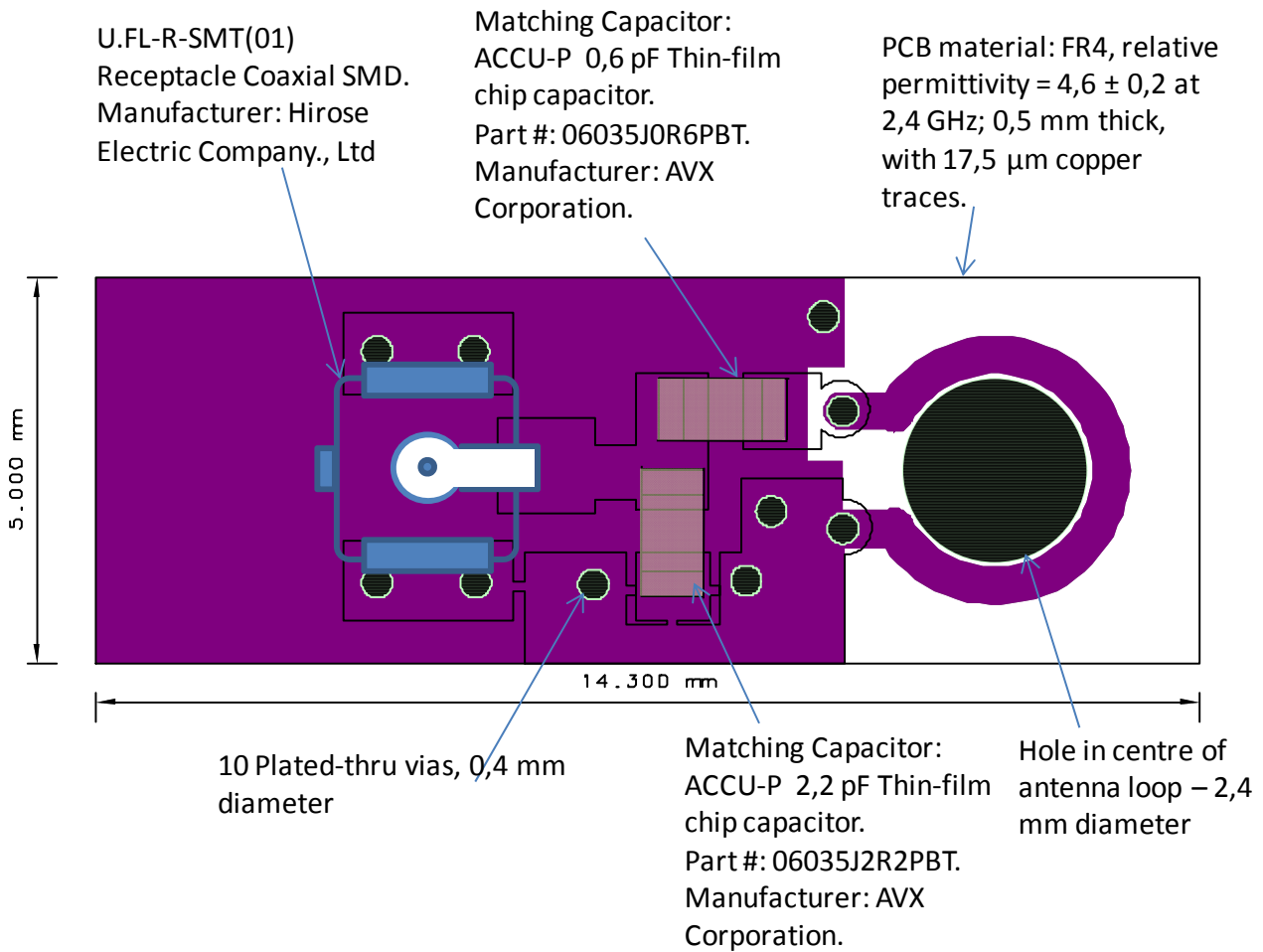

Figure C.1 — Reference Antenna #1 – Layout

Precise layout information for the antenna PCB is specified by the gerber artwork files that can be found at: <http://www.ecma-international.org/publications/standards/Ecma-391.htm>.

C.1.2 Antenna Validation

C.1.2.1 Antenna input return loss

The antenna input return loss as measured by a network analyser or similar instrument, when measured in a system having a characteristic impedance of 50 ohms, shall be greater than 6 dB at 2 442 MHz.

C.1.2.2 Antenna transmission loss

Two Reference Antennas #1 shall be used in this test.

Both antennas shall have passed the test specified in C.1.2.1.

The two antennas shall be placed 180 degrees rotated relative to each other and spaced $5\text{ mm} \pm 0.1\text{ mm}$ apart, and with their radiating patterns facing each other, and with the centres of the radiating loops on the same axis. Figure C.2 illustrates this arrangement.

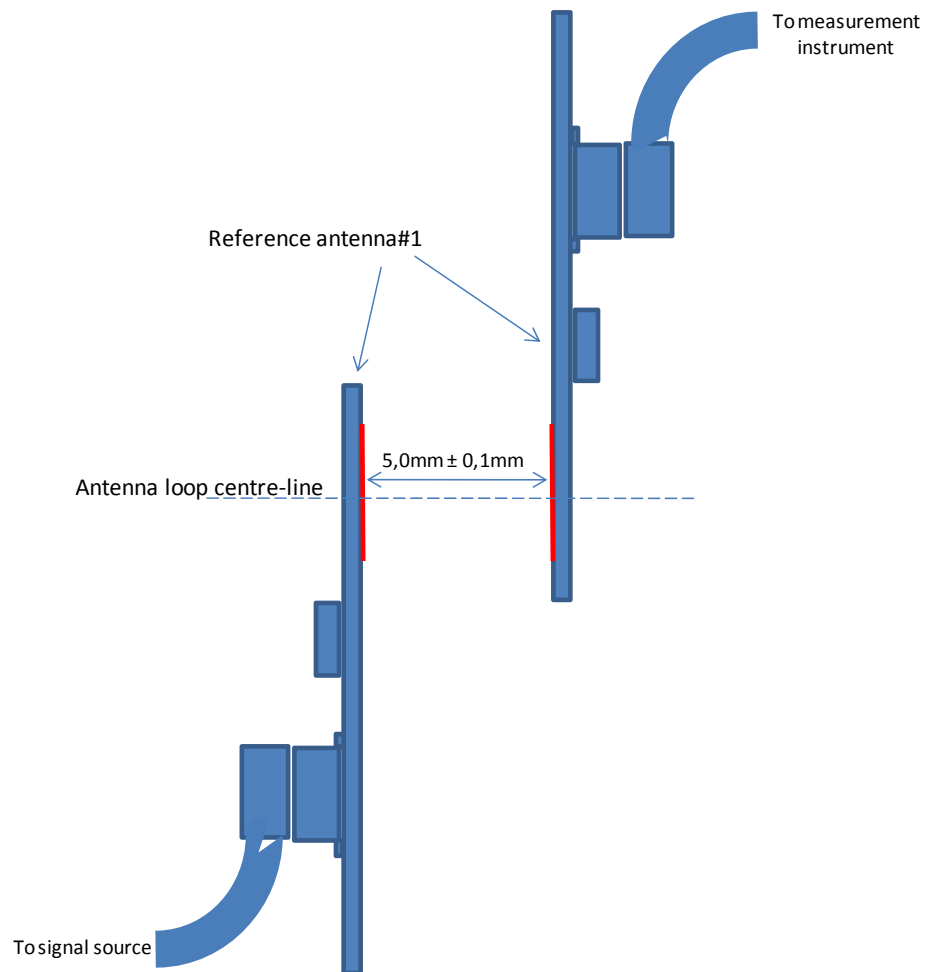

Figure C.2 — Antenna arrangement

The transmission loss between the two antennas shall be $10,5\text{ dB} \pm 1\text{ dB}$ at 2 442 MHz.

C.1.3 Use of Reference Antenna to measure radiated power and received power

Where use of the reference antenna is specified in this Standard, then the average of measurements in dB using both the antennas validated in C.1.2 shall be used to determine the actual performance obtained.

C.2 Reference Antenna #2

C.2.1 Design Information

Figure C.3, C.4 and C.5 specify the design of Reference Antenna #2.

Printed Circuit Board Material: Rogers Corporation RO4003C.

Thickness 0,032", 35 μm copper cladding.

Tolerance for Antenna radiating pattern dimensions: $\pm 0,02$ mm.

Tolerance for Board Outline dimensions: $\pm 0,25$ mm.

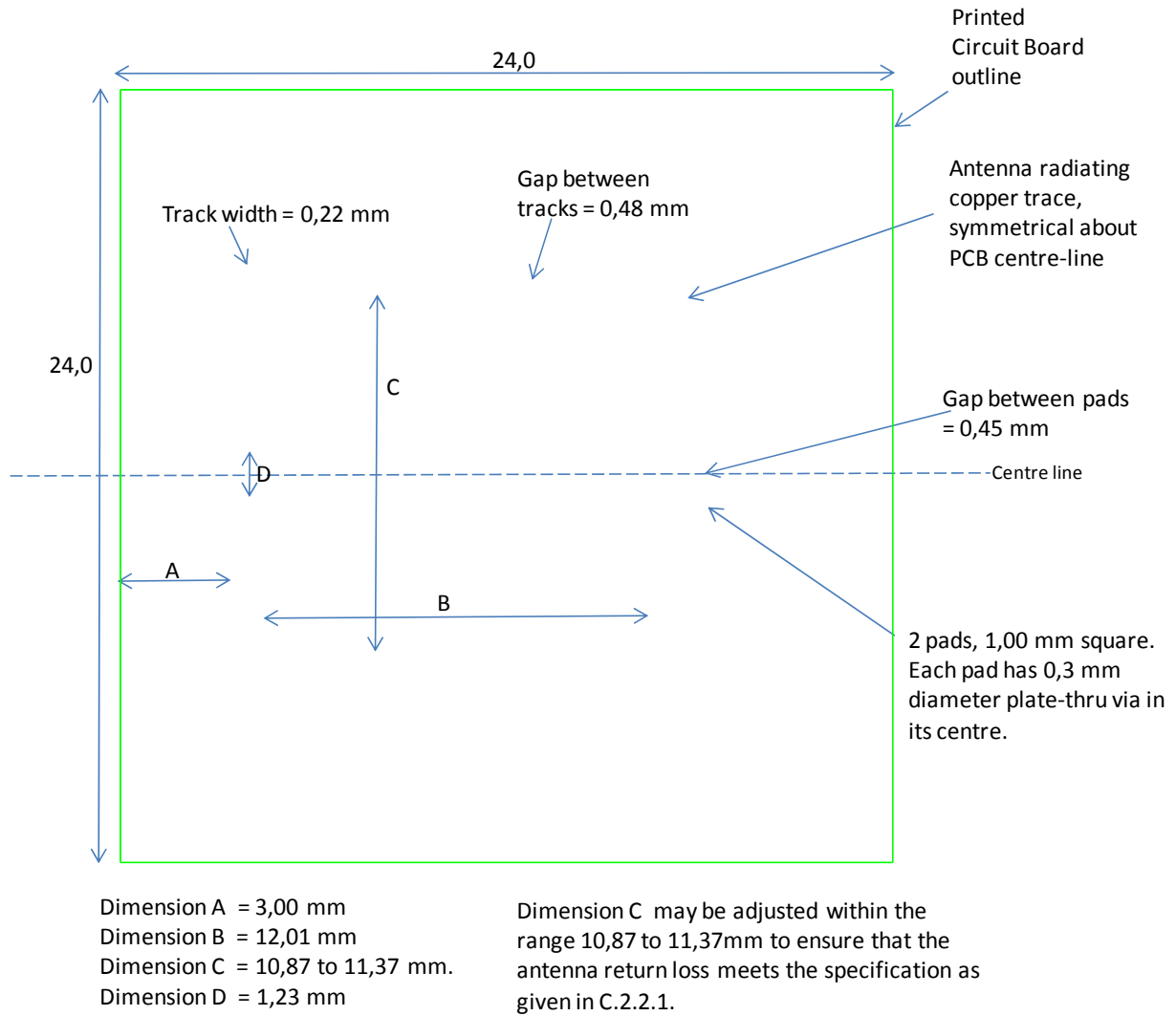

Figure C.3 — Reference Antenna #2 – Radiating pattern dimensions

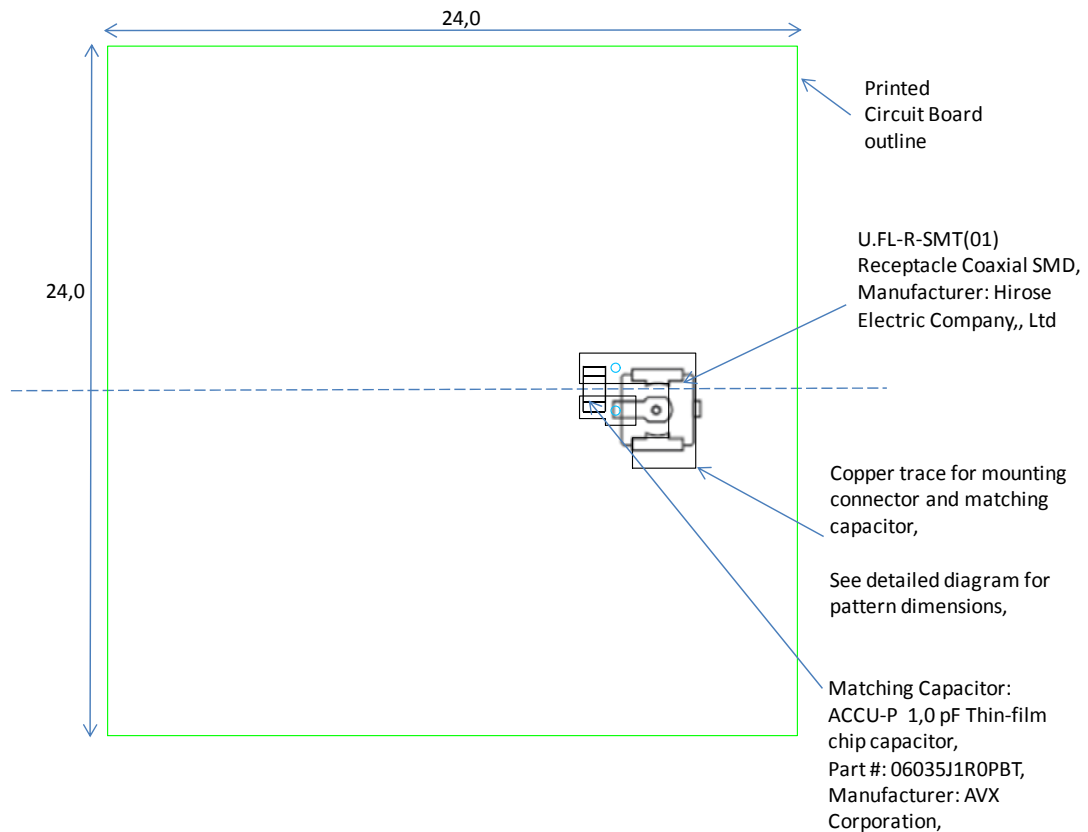

Figure C.4 — Reference Antenna #2 - Component-side layout

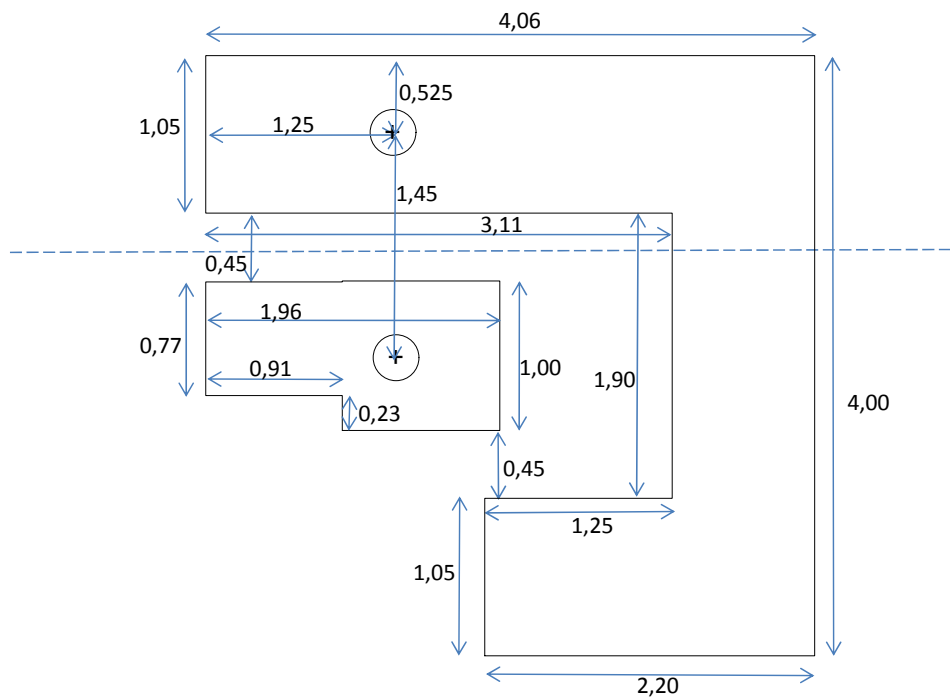

Figure C.5 — Reference Antenna #2 – Detailed component-side pattern dimensions

C.2.2 Antenna Validation

C.2.2.1 Antenna input return loss

The antenna input return loss as measured by a network analyser or similar instrument, when measured in a system having a characteristic impedance of 50 ohms, shall be greater than 15 dB at 2 442 MHz.

C.2.2.2 Antenna transmission loss

Two Reference Antennas #2 shall be used in this test.

Both antennas shall have passed the test specified in C.2.2.1.

The two antennas shall be placed in the same orientation and spaced $10\text{ mm} \pm 0.2\text{ mm}$ apart, and with their radiating patterns facing each other, and with the centre of the antenna's folded loops on the same axis.

The transmission loss between the two antennas shall be $4,5\text{ dB} \pm 1\text{ dB}$ at 2 442 MHz.

C.2.3 Use of Reference Antenna to measure radiated power and received power

Where use of the reference antenna is specified in this Standard, then the average of measurements in dB using both the antennas validated in C.2.2 shall be used to determine the actual performance obtained.

C.3 Reference Antenna #3

C.3.1 Design Information

Figure C.6 specifies the construction of the Reference Antenna#3.

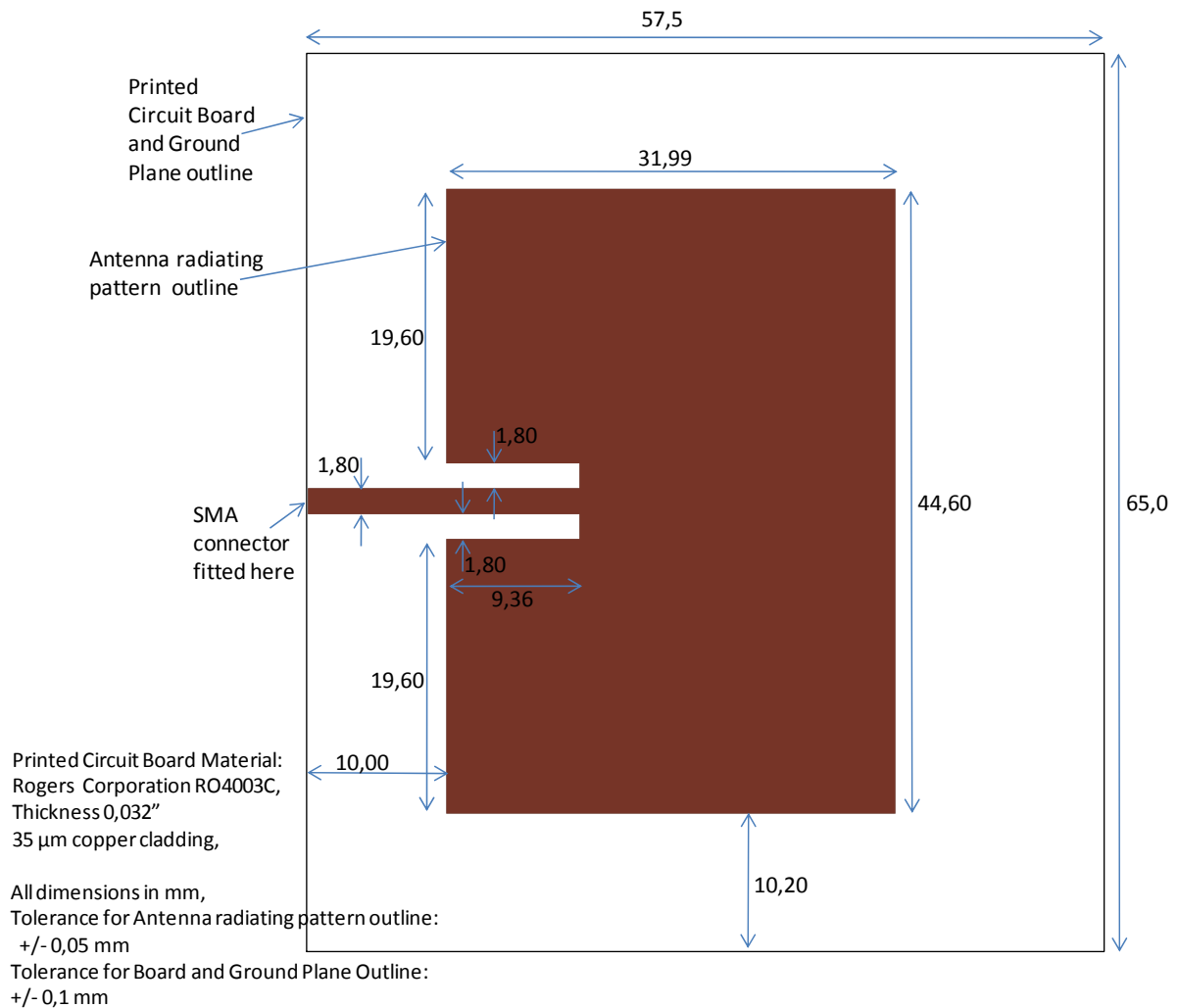

Figure C.6 — Design Information for Reference Antenna #3

C.3.2 Antenna Validation

C.3.2.1 Antenna input return loss

The antenna input return loss as measured by a network analyser or similar instrument, when measured in a system having a characteristic impedance of 50 ohms, shall be greater than 15 dB at 2 442 MHz.

C.3.2.2 Antenna transmission loss

Two Reference Antennas #3 shall be used in this test.

Both antennas shall have passed the test specified in C.3.2.1.

The two antennas shall be placed in the same orientation and spaced 100 mm \pm 1 mm apart, and with their radiating patterns facing each other.

The transmission loss between the two antennas shall be 11,0 dB \pm 0,5 dB at 2 442 MHz.

C.3.3 Use of Reference Antenna to measure radiated power and received power

Where use of the reference antenna is specified in this Standard, then the average of measurements in dB using both the antennas validated in C.3.2 shall be used to determine the actual performance obtained.

