

**Standard** ECMA-401

1<sup>st</sup> Edition / December 2011

**Close Capacitive  
Coupling  
Communication  
Physical Layer  
(CCCC PHY)**

**Standard**



is the registered trademark of Ecma International



**COPYRIGHT PROTECTED DOCUMENT**

<b>Contents</b>	<b>Page</b>
1 Scope .....	1
2 Conformance .....	1
3 Normative references .....	1
4 Terms, definitions and acronyms .....	1
5 Conventions and notations .....	2
5.1 Representation of numbers .....	2
5.2 Names .....	2
6 General .....	2
7 Reference plate-electrode assembly .....	4
8 PHY parameters .....	5
8.1 Voltage conditions .....	5
8.2 Bit representation .....	6
8.2.1 Bit duration .....	6
8.2.2 Bit encoding .....	6
8.3 Transmission .....	6
8.4 DC balance of a P-PDU .....	6
8.5 Reception of a P-PDU .....	7
9 P-PDU .....	7
9.1 Structure .....	7
9.2 Space .....	7
9.3 Level adjust .....	7
9.4 Pre-amble and Sync .....	7
9.5 Attribute .....	8
9.6 TDS number .....	8
9.7 Sequence number .....	9
9.7.1 Initial and range .....	9
9.7.2 Acknowledgement .....	9
9.8 Payload .....	9
9.9 CRC .....	9
9.10 Post-amble .....	9
9.11 Null P-PDU .....	9
9.12 Data P-PDU .....	9
10 PHY Data Unit (P-DU) .....	9
11 Segmentation and Reassembly .....	9
12 TDS .....	10
13 LBT and synchronisation .....	11
13.1 LBT .....	11
13.2 Synchronisation .....	11
14 Association procedure .....	11
15 Communication .....	13
15.1 Full duplex communication .....	13
15.2 Broadcast communication .....	15
<b>Annex A (normative) Tests .....</b>	<b>17</b>
<b>A.1 Reference plate-electrode test .....</b>	<b>17</b>

A.2	P-PDU DC balance test.....	18
A.3	Protocol test.....	18
A.3.1	Test setup.....	18
A.3.2	Test scenario 1.....	19
A.3.3	Test scenario 2.....	19
A.3.4	Test scenario 3.....	19
A.3.5	Test scenario 4.....	19
A.3.6	Test scenario 5.....	20
A.3.7	Test scenario 6.....	20
A.3.8	Test scenario 7.....	20
A.3.9	Test scenario 8.....	20



## **Introduction**

This Standard specifies the PHY protocol and for wireless communication between the Close Capacitive Coupling Communication (CCCC) devices.

This Ecma Standard has been adopted by the General Assembly of December 2011.

**"COPYRIGHT NOTICE**

*This document may be copied, published and distributed to others, and certain derivative works of it may be prepared, copied, published, and distributed, in whole or in part, provided that the above copyright notice and this Copyright License and Disclaimer are included on all such copies and derivative works. The only derivative works that are permissible under this Copyright License and Disclaimer are:*

- (i) works which incorporate all or portion of this document for the purpose of providing commentary or explanation (such as an annotated version of the document),*
- (ii) works which incorporate all or portion of this document for the purpose of incorporating features that provide accessibility,*
- (iii) translations of this document into languages other than English and into different formats and*
- (iv) works by making use of this specification in standard conformant products by implementing (e.g. by copy and paste wholly or partly) the functionality therein.*

*However, the content of this document itself may not be modified in any way, including by removing the copyright notice or references to Ecma International, except as required to translate it into languages other than English or into a different format.*

*The official version of an Ecma International document is the English language version on the Ecma International website. In the event of discrepancies between a translated version and the official version, the official version shall govern.*

*The limited permissions granted above are perpetual and will not be revoked by Ecma International or its successors or assigns.*

*This document and the information contained herein is provided on an "AS IS" basis and ECMA INTERNATIONAL DISCLAIMS ALL WARRANTIES, EXPRESS OR IMPLIED, INCLUDING BUT NOT LIMITED TO ANY WARRANTY THAT THE USE OF THE INFORMATION HEREIN WILL NOT INFRINGE ANY OWNERSHIP RIGHTS OR ANY IMPLIED WARRANTIES OF MERCHANTABILITY OR FITNESS FOR A PARTICULAR PURPOSE."*

# Close Capacitive Coupling Communication Physical Layer (CCCC PHY)

## 1 Scope

This Standard specifies the CCCC PHY for Full duplex and Broadcast communication in time slots on frequency division multiplex channels.

## 2 Conformance

Conforming entities implement:

- both Talker and Listener,
- listen before talk (LBT) for both Talker and Listener,
- the capability to execute association on FDC2 and to communicate on (FDC0 and FDC1), (FDC3 and FDC4), or (FDC0, FDC1, FDC3 and FDC4),
- the capability for Talkers and Listeners to use any of the 8 TDS on a FDC,
- both Full duplex and Broadcast communication, and pass the tests in Annex A as specified herein.

## 3 Normative references

The following referenced documents are indispensable for the application of this document. For dated references, only the edition cited applies. For undated references, the latest edition of the referenced document (including any amendments) applies.

ISO/IEC 7498-1:1994, *Information technology — Open Systems Interconnection — Basic Reference Model: The Basic Model*

ITU-T V.41, *Data communication over the telephone network – Code-independent error-control system*

## 4 Terms, definitions and acronyms

For the purposes of this document, the following terms and definitions apply, in addition to those defined in ISO/IEC 7498-1:1994.

CRC	Cyclic Redundancy Check
D	Divisor
DUT	Device Under Test
FDC	Frequency Division Channel
LBT	Listen Before Talk

LEN	Length
Listener	entity that does not initiate communication
P-DU	PHY Data Unit
P-PDU	PHY PDU
PHY	Physical layer
RFU	Reserved for Future Use
TDS	Time Division Slot
Talker	entity that initiates communication

## 5 Conventions and notations

### 5.1 Representation of numbers

The following conventions and notations apply in this document.

- A sequence of characters of 'A', 'B', 'C', 'D', 'E' or 'F' and decimal digits in parentheses represent numbers in hexadecimal notation unless followed by a 'b' character see next.
- Numbers in binary notation and bit patterns are represented by a sequence of 0 and 1 digits or 'X' characters in parentheses followed by a 'b' character, e.g. (0X11X010)b. Where X indicates that the setting of a bit is not specified, and the leftmost bit is the most significant bit unless the sequence is a bit pattern.

### 5.2 Names

The names of basic elements, e.g. specific fields, are written with a capital initial letter.

## 6 General

The protocol architecture of CCCC follows ISO/IEC 7498-1 as the basic model. CCCC devices communicate through mediators, such as conductive and dielectric materials.

Plate-electrodes for CCCC device E and F are equivalent to the reference plate-electrode assembly.

The plate-electrode A faces to the imaginary point at infinity and the plate-electrode B faces to the mediator. The plate-electrode C faces to the mediator and the plate-electrode D faces to the imaginary point at infinity. See Figure 1.

Figure 2 is the equivalent circuit of Figure 1. The voltage of X is the potential of the point at infinity. The voltage of Y is the potential of the point at infinity. It is deemed that the potential of X and Y is identical. Therefore, X and Y is imaginary short. Consequently, device E and F is able to send and receive signal.

Regarding the information transfers from CCCC device E to F, the device E changes the voltage between plate-electrode A and B. It changes the electric charge between plate-electrode B and the mediator. The change in electric charge affects the device F by the capacitive coupling between plate-electrode C and mediator. Plate-electrodes A and B and plate-electrodes C and D have potential differences of reverse polarity; therefore device F senses the information as changes in voltage between plate-electrode C and D.



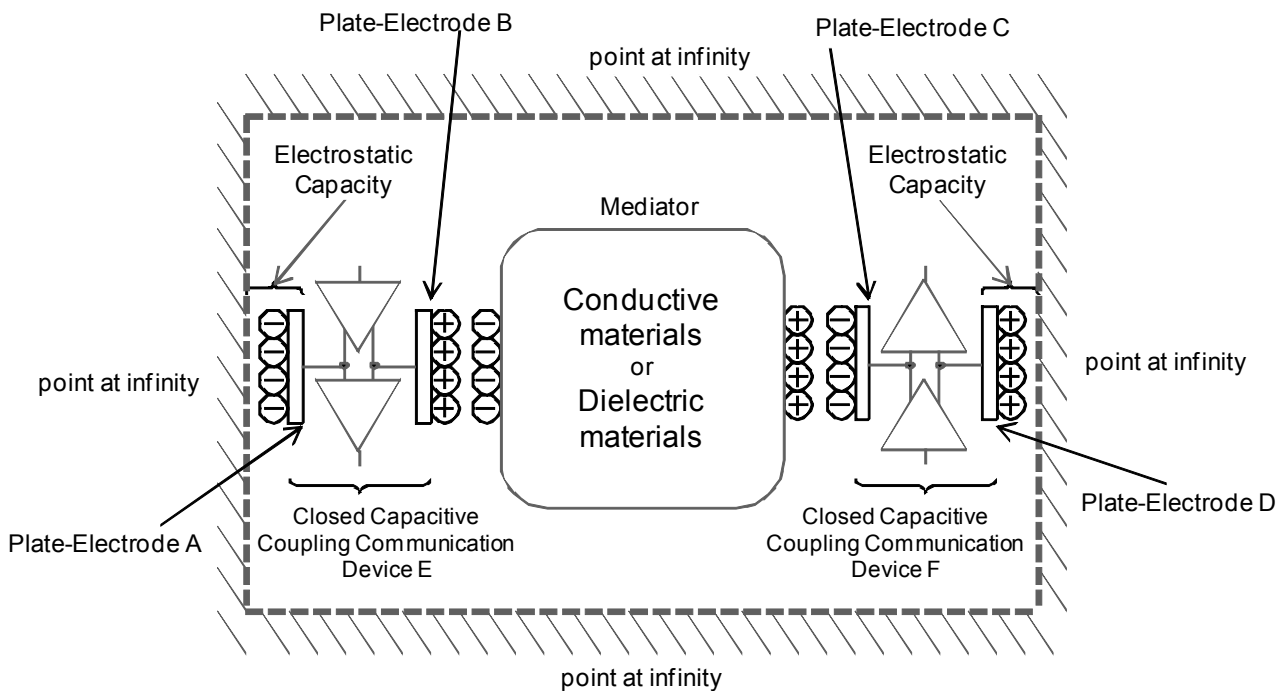

**Figure 1 — Electrical model**

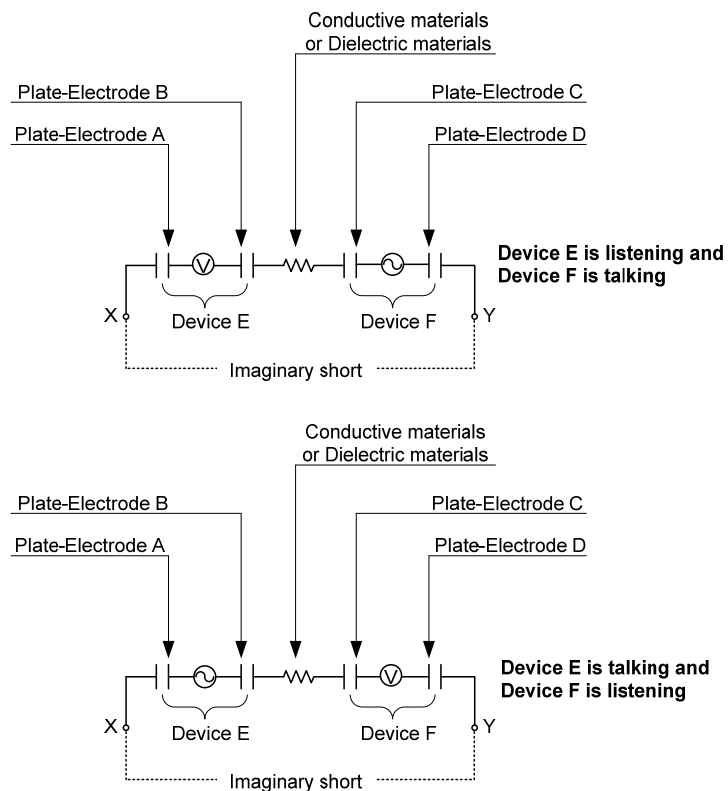

**Figure 2 — Equivalent circuit**

Information transfer between CCCC device E and F takes place by the synchronous communication, see 13.1. 8.2.1 specifies 5 frequency division channels (FDC) by division of the centre frequency. Each FDC consists of a sequence of time-segments. Each time-segment consists of 8 time division slots (TDS) for time division multiple-access, see Clause 12. Peers use the Listen Before Talk (LBT) procedure in 13.1 to ascertain that a TDS is not occupied. The TDSs are negotiated using the association procedure specified in Clause 14.

15.1 and 15.2 specify Full duplex and Broadcast communication respectively. In Full duplex communication, Talkers and Listeners exchange P-PDUs (see Clause 9) by synchronous communication. In Broadcast communication Talkers broadcast P-PDUs and Listeners receive P-PDUs without acknowledging.

Length information and CRC is added to the SDU to construct a PHY Data Unit (P-DU), see Clause 10. The sender segments the P-DU into P-PDUs. The receiving entity reassembles the P-PDUs into the P-DU, see Clause 11, and forwards the SDU to its PHY User as illustrated in Figure 3.

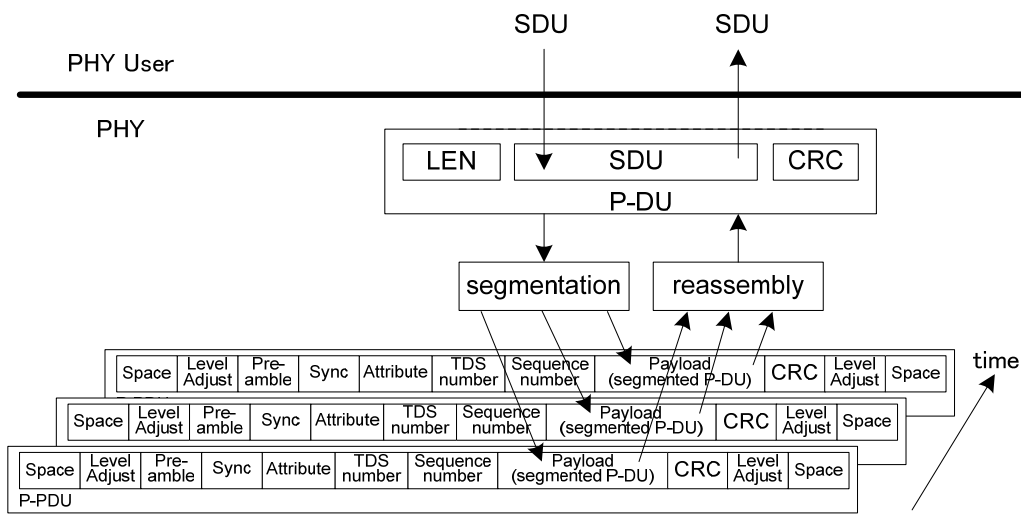

Figure 3 — PHY model

## 7 Reference plate-electrode assembly

The reference plate-electrode assembly for the CCCC devices shall consist of plate-electrode *A* and plate-electrode *B* specified in Figure 4. Dimensional characteristics are specified for those parameters deemed to be mandatory.

$$a = 20,0 \pm 0,1 \text{ mm}$$

$$b = 20,0 \pm 0,1 \text{ mm}$$

The distance *c* between plate-electrode *A* and *B* shall be  $5,0 \pm 0,1$  mm by horizontal flat surface.

$$d = 0,30 \pm 0,03 \text{ mm}$$

The displacement of centre of area *e* between plate-electrode *A* and *B* shall be at most 0,1 mm.

The material of the plate-electrodes shall be 99% to 100% copper or equivalent.

The twisted-pair wire shall be connected inside the circle area  $f$  specified in Figure 4. The  $f$  has a diameter of  $2,0 \pm 0,5$  mm. The twisted-pair wire shall be stranded wire and 26, 27, or 28 specified American Wire Gauge (AWG). The length of the twisted-pair wire for the reference plate-electrode assembly shall be less than 1,0 m.

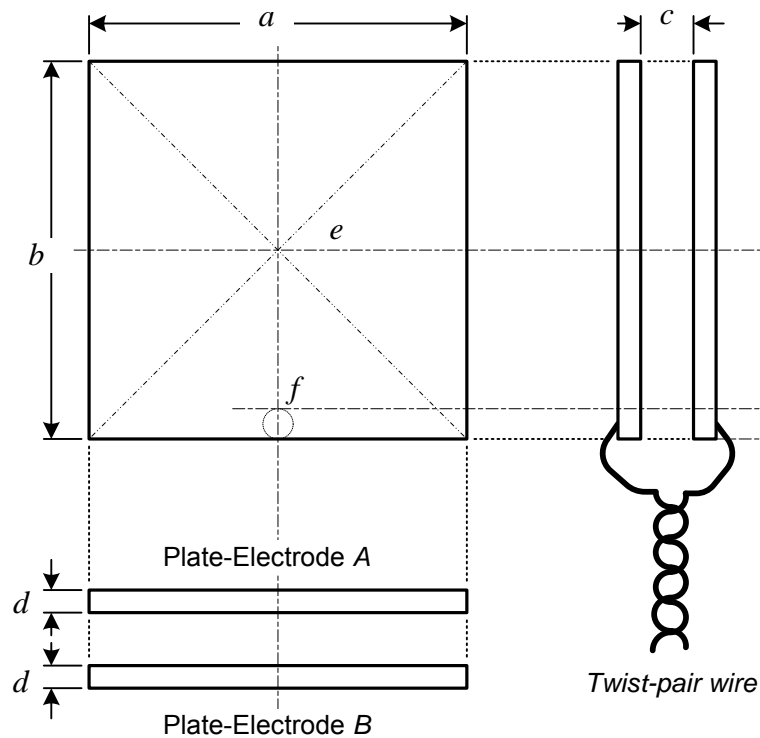

Figure 4 — CCC reference plate-electrode assembly

## 8 PHY parameters

### 8.1 Voltage conditions

The following conditions of the voltage between the outer and the inner plate-electrode shall be used for communication.

- +m volts
- -m volts
- 0 volt
- OPEN

The value  $m$  depends on implementations. 0 volt is achieved by shorting the two plate-electrodes in a plate-electrode assembly. OPEN is achieved by disconnection of the plate-electrode assembly from the driver circuits.

## 8.2 Bit representation

### 8.2.1 Bit duration

The centre frequency  $f_c$  is 40,68 MHz  $\pm$  50 ppm.

The bit duration  $T$  equals  $D/f_c$  seconds.

Table 1 specifies the relation between FDC and  $D$ .

Table 1 — FDC and  $D$

FDC	$D$
0	11
1	7
2	5
3	3
4	1

### 8.2.2 Bit encoding

Manchester bit encoding is specified in Figure 5. Depending on the relative orientation, bits are received with either positive or negative polarity. The half bit time transition shall be between  $0,4 T$  and  $0,6 T$ .

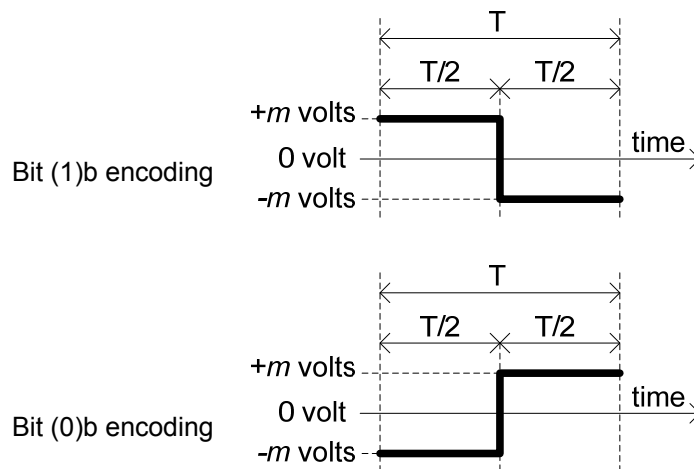

Figure 5 — Bit encoding

## 8.3 Transmission

P-PDUs shall be transmitted byte-wise in the sequence specified in 9.1. Bytes shall be transmitted with least significant bit first.

## 8.4 DC balance of a P-PDU

The DC balance of a P-PDU is  $(S_p - S_n) / (S_p + S_n) \times 100$  [%] where  $S_p$  is the integral of the positive voltage parts of one P-PDU and where  $S_n$  is the integral of the negative voltage parts of one P-PDU. The DC balance shall be less than  $\pm 10$  % per P-PDU.

## 8.5 Reception of a P-PDU

While receiving a P-PDU, receivers shall put the voltage condition to OPEN.

## 9 P-PDU

### 9.1 Structure

Figure 6 specifies the P-PDU as a sequence of 0,5 T of Space, 1,5 T of Level adjust, 2 T of Pre-amble, 5 T of Sync, 2 T of Attribute, 3 T of TDS number, 2 T of Sequence number, 32 T of Payload, 16 T of CRC, and 2 T of Post-amble. The P-PDU continues/ends with 1,5T of Level adjust and another 0,5T Space. The bit encoding specified in 8.2.2 shall be applied to Attribute, TDS number, Sequence number, Payload, and CRC.

66 T is represented by  $t_1, t_2, t_3, \dots, t_{66}$ .

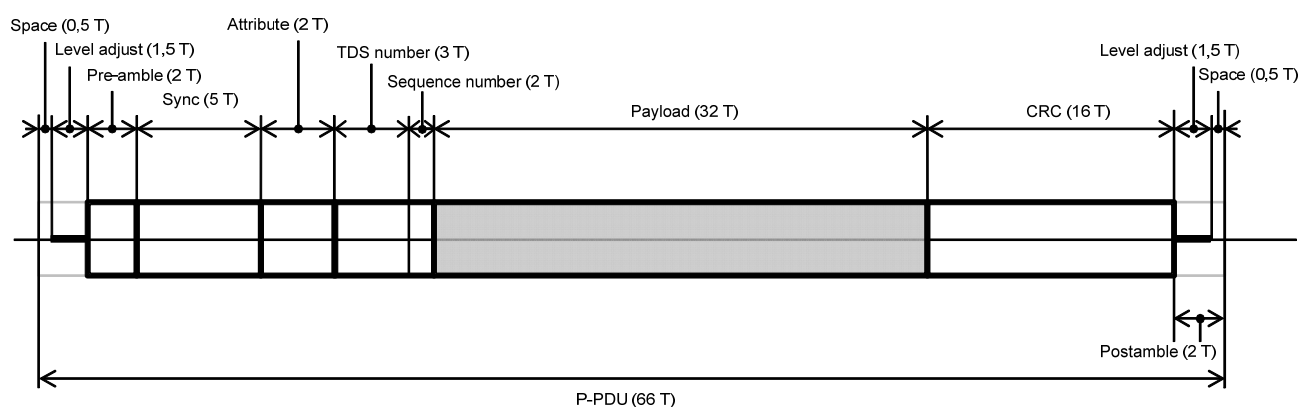

Figure 6 — P-PDU structure

### 9.2 Space

The Space duration shall be 0,5 T with voltage condition OPEN.

### 9.3 Level adjust

Level adjust shall be 1,5 T of 0 volt.

### 9.4 Pre-amble and Sync

Figure 7 specifies Pre-amble and Sync patterns. The transmitter shall apply pattern *P*. If the receiver detects Sync pattern *P* then it shall decode the bits in a P-PDU as positive polarity. If the receiver detects Sync pattern *Q* then it shall decode the bits in a P-PDU as negative polarity. The divisor value shall be detected from Pre-amble and Sync. Other patterns shall not be handled as Pre-amble and Sync.

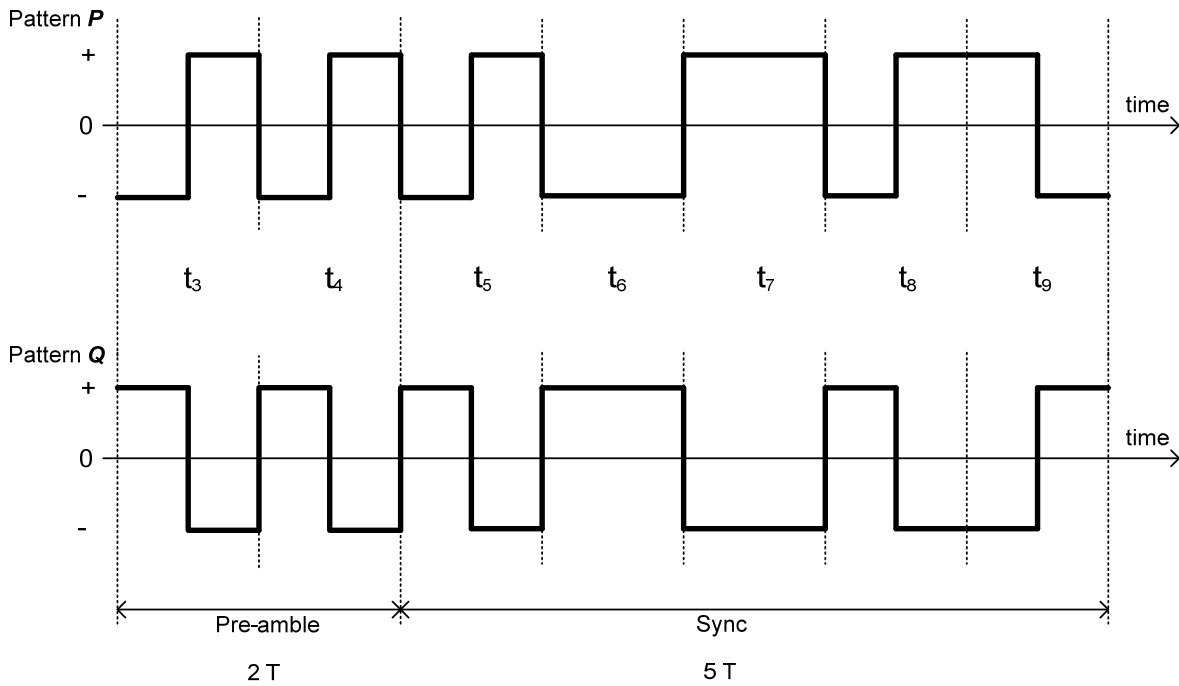

**Figure 7 — Pre-amble and Sync patterns**

### 9.5 Attribute

Table 2 specifies the bit encodings of the attribute settings in a P-PDU.

**Table 2 — Attribute settings**

$t_{10}$	$t_{11}$	Definition	
		FDC2	FDC0, FDC1, FDC3, and FDC4
0	0	Association Request 1 or Association Response 2	Null P-PDU
0	1	Association Response 2 or Association Request 2	The last Data P-PDU
1	0	RFU	The first Data P-PDU
1	1	RFU	Data P-PDU between the first and the last Data P-PDU

If a receiver gets RFU attribute settings it shall ignore the P-PDU and stay mute.

### 9.6 TDS number

The TDS number field shall indicate the slot number in which the P-PDU is send; numbers 1 to 8 are identified by (000)b to (111)b.

## 9.7 Sequence number

### 9.7.1 Initial and range

P-PDUs shall be identified by the sequence numbers in the range of (00)b to (11)b. The first P-PDU shall have (00)b in the sequence number field.

### 9.7.2 Acknowledgement

To acknowledge correct reception, receivers shall increment the sequence number by 1 (modulo 4) from the correctly received P-PDU as the sequence number in the next P-PDU.

## 9.8 Payload

The payload field of a P-PDU contains 4 bytes.

## 9.9 CRC

The scope of CRC shall be the last 1 T of Sync as a bit, Attribute, TDS number, Sequence number, and Payload. The CRC shall be calculated according to ITU-T V.41 with pre-set value (FF FF). If the CRC of the received P-PDU and the calculated CRC upon reception differ, the P-DU shall be ignored.

Example: with Attribute (11)b, TDS number (010)b, Sequence number (10)b, Payload (55 AA 00 FF) the CRC is (6F AB).

### 9.10 Post-amble

Post-ambles consist of 1,5 T of Level adjust and 0,5 T of Space.

### 9.11 Null P-PDU

Null P-PDUs have Attribute of (00)b and a payload (00 00 00 00).

### 9.12 Data P-PDU

Data P-PDUs have a payload with a (possibly segmented) P-DU.

## 10 PHY Data Unit (P-DU)

Figure 8 specifies the P-DU. It shall consist of LEN, SDU, and CRC.

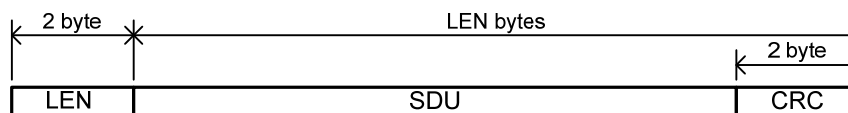
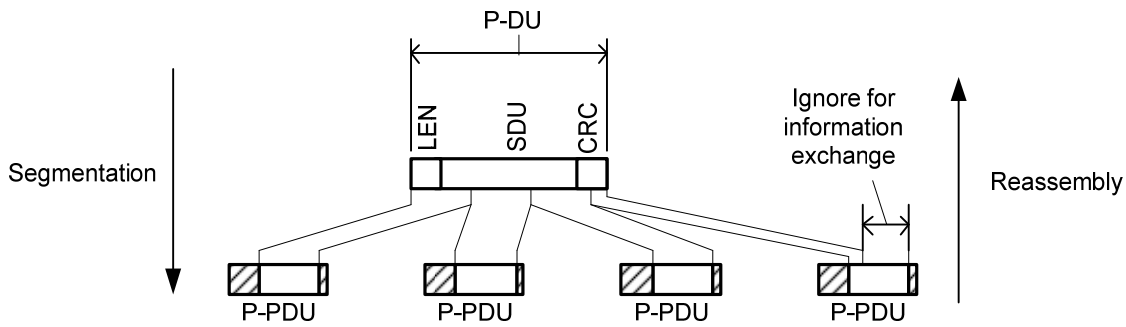

Figure 8 — PHY Data Unit (P-DU)

LEN contains the length of SDU in bytes + 2. The CRC shall be calculated over the LEN value and the SDU according to ITU-T V.41. The pre-set value shall be (FFFF).

## 11 Segmentation and Reassembly

P-DU shall be segmented and reassembled into 4 byte payloads of P-PDU as illustrated in Figure 9, by using the Attribute settings in Table 2.

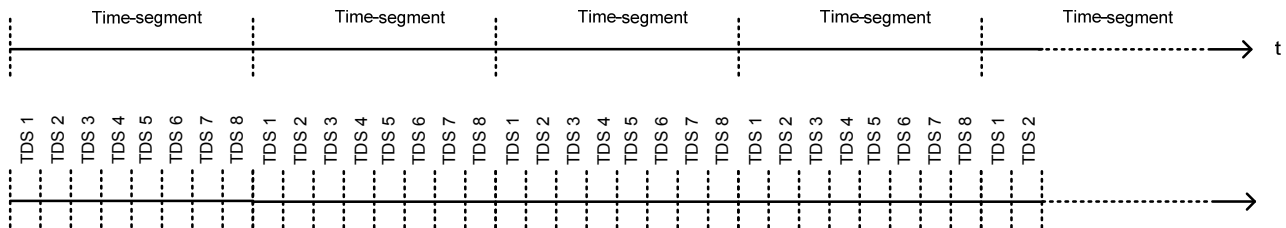

**Figure 9 — Segmentation and Reassembly**

## 12 TDS

A TDS is 64 T wide. A P-PDU which is 66 T wide (see Figure 6), shall be transmitted in one TDS. See Figure 11.

TDSs shall be numbered from 1 to 8 in each time segment as illustrated in Figure 10.



**Figure 10 — Time-segment and TDS**

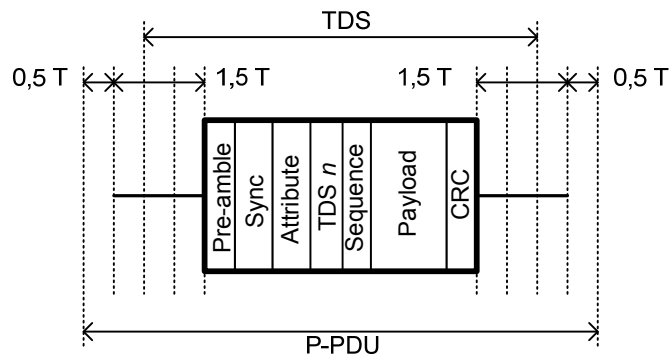

**Figure 11 — Mapping of a P-PDU and a TDS**

This Standard specifies Full duplex and Broadcast communication. A TDS is used for unidirectional communication. A Full duplex channel consists of two TDSs and one TDS is used for Broadcast communication.

The TDS may be either fixed by configuration or be negotiated.



Talkers may either use fixed configured TDS(s) on FDC1 or FDC3 or alternatively negotiate using TDS(s) on FDC1 or FDC3 using the association procedure. Talkers that select FDC0 or FDC4 shall negotiate TDS using the association procedure in Clause 14.

Before using a TDS, entities shall use LBT and synchronisation.

## 13 LBT and synchronisation

### 13.1 LBT

During LBT, entities shall listen for 576 T on the selected FDC to seek a free TDS. A TDS is occupied when the entities receive a correct P-PDU.

### 13.2 Synchronisation

If all TDSs on the FDC that the Talker selects are found to be free using LBT, then that Talker shall generate the TDS timing on its selected FDC. Otherwise the Talkers shall synchronise to the TDS timing on the FDC using LBT. Listeners shall always synchronise to the TDS timing on the FDC using LBT.

## 14 Association procedure

Talkers use the association procedure to negotiate the communication TDS(s). During this procedure, Talkers and Listeners exchange the P-PDUs on 2 Full duplex TDS in FDC2, in the following steps:

1. Talker selects a free association TDS in the range from 0 to 3 in FDC2, using LBT.
2. Talker selects (1 for Broadcast and 2 for Full duplex) free slot(s) in an FDC other than FDC2, using LBT.
3. Talker sends Association Request 1 P-PDU specified in Table 3 on the association TDS from step 1 with Attribute (00)b, Sequence number (00)b and FDC/TDS(s) from step 2 and the selected communication mode.
4. Listener sends Association Response 1 P-PDU specified in Table 4 on the association TDS number + 4 with Attribute (01)b, Sequence number (01)b and random number.
5. Talker sends Association Request 2 P-PDU specified in Table 4 on the association TDS from step 1 with Attribute (01)b, Sequence number (10)b and the random number from Association Response 1.
6. Listener sends Association Response 2 P-PDU specified in Table 3 on the association TDS number + 4 with Attribute (00)b, Sequence number (11)b and FDC/TDS(s) from Association Request 1.
7. Peers attempt communication as specified in Clause 15 on the FDC/TDS(s) from Association Request 1.
8. If the FDC/TDS(s) from Association Request 1 are occupied peers may repeat this association procedure.

Figure 12 illustrates steps 3 to 6.

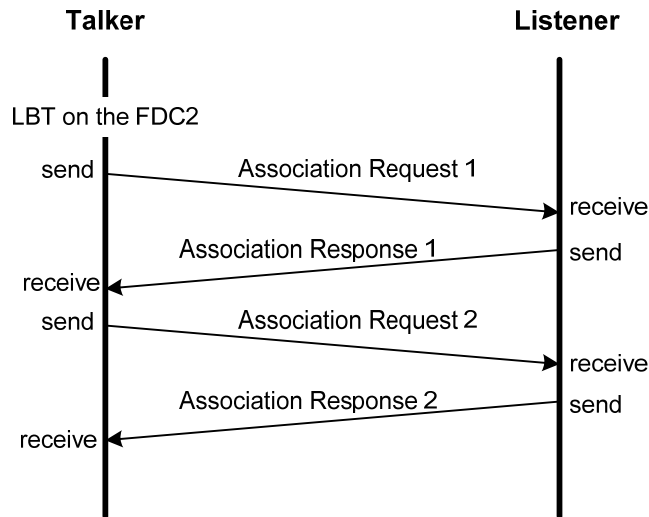

Figure 12 — Association

Table 3 — Payload with parameters of Association Request 1 and Association Response 2 P-PDU

Payload	Settings																	
t <sub>48</sub>	Shall be one's complement of t <sub>17</sub> , t <sub>18</sub> , t <sub>19</sub> , t <sub>20</sub> , t <sub>21</sub> , t <sub>22</sub> , t <sub>23</sub> , t <sub>24</sub> , t <sub>25</sub> , t <sub>26</sub> , t <sub>27</sub> , t <sub>28</sub> , t <sub>29</sub> , t <sub>30</sub> , t <sub>31</sub> , t <sub>32</sub>																	
t <sub>47</sub>																		
.																		
.																		
.																		
t <sub>34</sub>																		
t <sub>33</sub>																		
t <sub>32</sub>	RFU																	
t <sub>31</sub>	RFU																	
t <sub>30</sub>	RFU																	
t <sub>29</sub>	RFU																	
t <sub>28</sub>	RFU																	
t <sub>27</sub>	0	Full duplex communication				0	Broadcast communication				Other settings are RFU							
t <sub>26</sub>	0					1												
t <sub>25</sub>	0					0												
t <sub>24</sub>	0	Listener uses	1	Listener uses	0	Listener uses	1	Listener uses	0	Listener Uses	1	Listener uses	0	Listener uses	1	Listener uses		
t <sub>23</sub>	0		0		1		1		0		0		1		1			
t <sub>22</sub>	0	TDS 1	0	TDS 2	0	TDS 3	0	TDS 4	1	TDS 5	1	TDS 6	1	TDS 7	1	TDS 8		
t <sub>21</sub>	0	Talker uses	1	Talker uses	0	Talker uses	1	Talker uses	0	Talker Uses	1	Talker uses	0	Talker uses	1	Talker uses		
t <sub>20</sub>	0		0		1		1		0		0		1		1			
t <sub>19</sub>	0	TDS 1	0	TDS 2	0	TDS 3	0	TDS 4	1	TDS 5	1	TDS 6	1	TDS 7	1	TDS 8		
t <sub>18</sub>	0	Use FDC 0				1	Use FDC 4				Other settings are RFU							
t <sub>17</sub>	0					1												

**Table 4 — Payload with parameters of Association Response 1 and Association Request 2 P-PDU**

Payload	Settings
t <sub>48</sub>	Shall be one's complement of t <sub>17</sub> , t <sub>18</sub> , t <sub>19</sub> , t <sub>20</sub> , t <sub>21</sub> , t <sub>22</sub> , t <sub>23</sub> , t <sub>24</sub> , t <sub>25</sub> , t <sub>26</sub> , t <sub>27</sub> , t <sub>28</sub> , t <sub>29</sub> , t <sub>30</sub> , t <sub>31</sub> , t <sub>32</sub>
t <sub>47</sub>	
.	
.	
t <sub>34</sub>	
t <sub>33</sub>	
t <sub>32</sub>	
t <sub>31</sub>	
.	
.	
.	
t <sub>18</sub>	
t <sub>17</sub>	

## 15 Communication

Entities exchange P-PDUs (see Clause 11) using either Full duplex or Broadcast communication.

Entities shall send Null P-PDUs when there is no P-DU (see Clause 10) pending until the PHY User stops communication.

### 15.1 Full duplex communication

See 9.7.1 for the rules on the sequence numbering.

The sender shall resend the current P-PDU until it is acknowledged. See 9.7.2.

The next P-PDU shall have a sequence number of the (last received sequence number + 1) modulo 4.

Figure 13 illustrates Full duplex communication without any errors.

Figure 14 illustrates a Full duplex communication flow with receive errors.

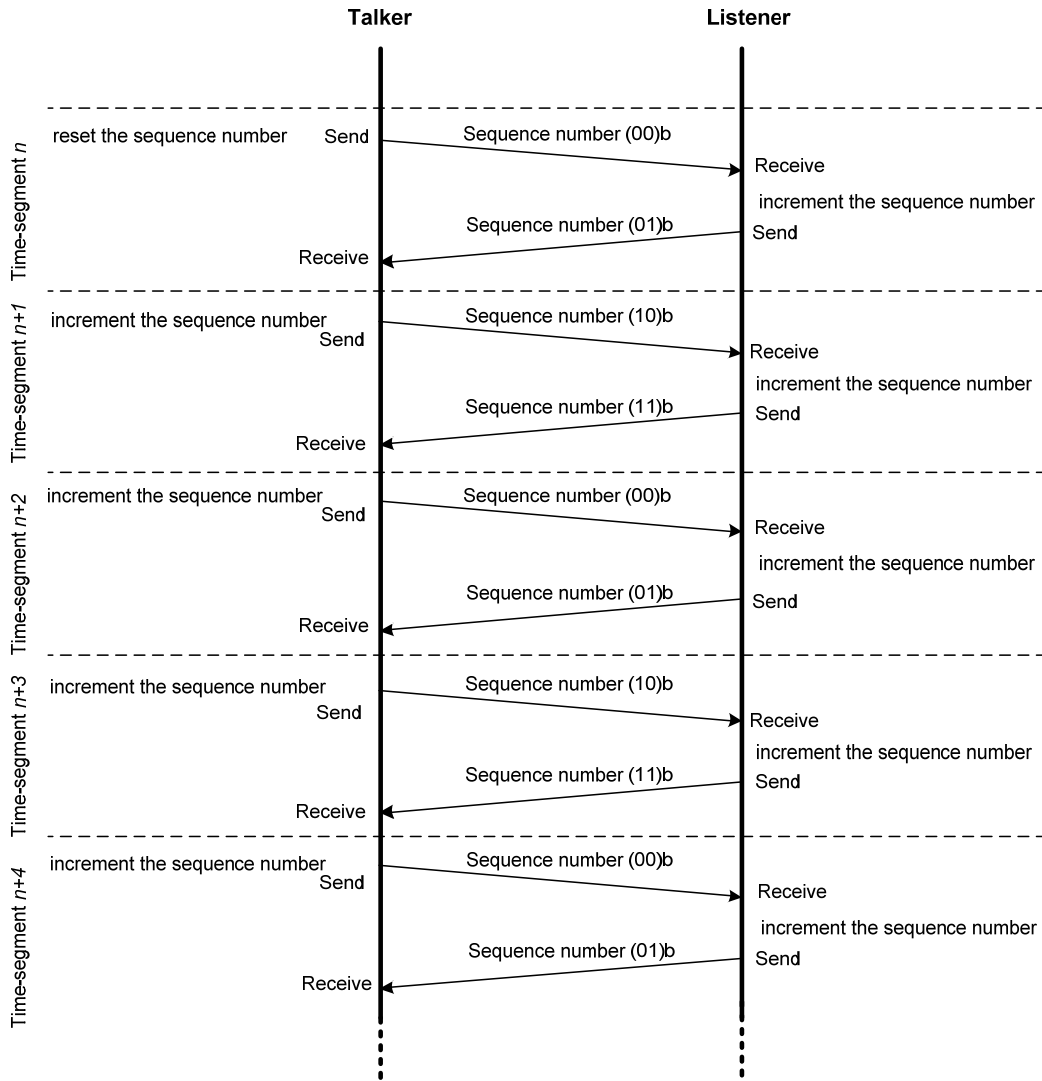

**Figure 13 — Example flow of Full duplex communication**

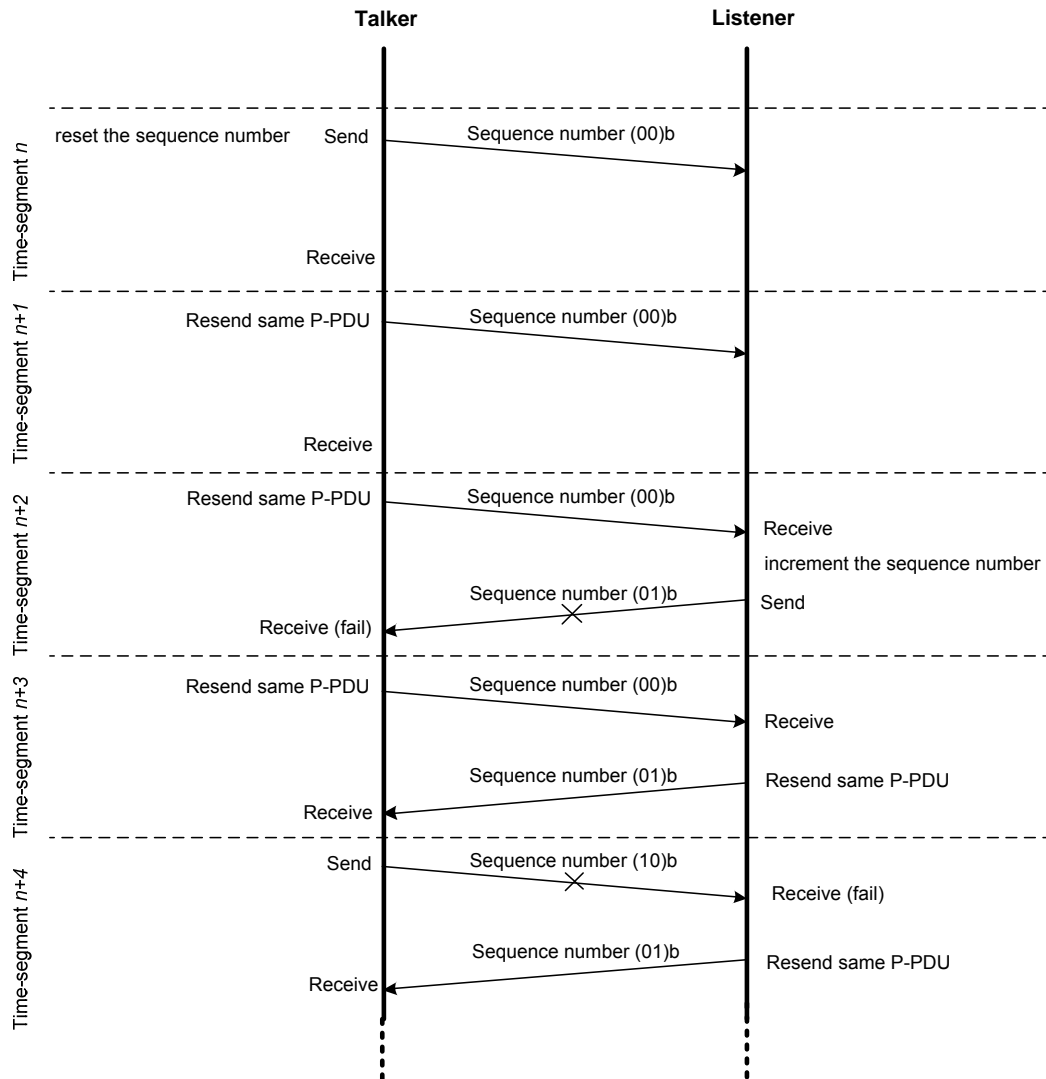

Figure 14 — Example flow of Full duplex communication with some resending

## 15.2 Broadcast communication

Broadcast communication is unidirectional and unacknowledged.

For broadcast communication, the Talker (hereafter referred to as Broadcaster) shall use the LBT procedure in 13.1 to find a free TDS on FDC0 or FDC4.

Any numbers of receivers may receive broadcasted P-PDUs.

See 9.7.1 for the rules on the sequence numbering.

The Broadcaster may repeatedly send identical P-PDUs. The next P-PDU shall have a sequence number of the (last sent sequence number + 1) modulo 4.

Note: Repeating identical P-PDUs may increase communication robustness.

Figure 15 illustrates broadcast communication flow. In this example, the Broadcaster sends identical P-PDUs in 2 time-segments.

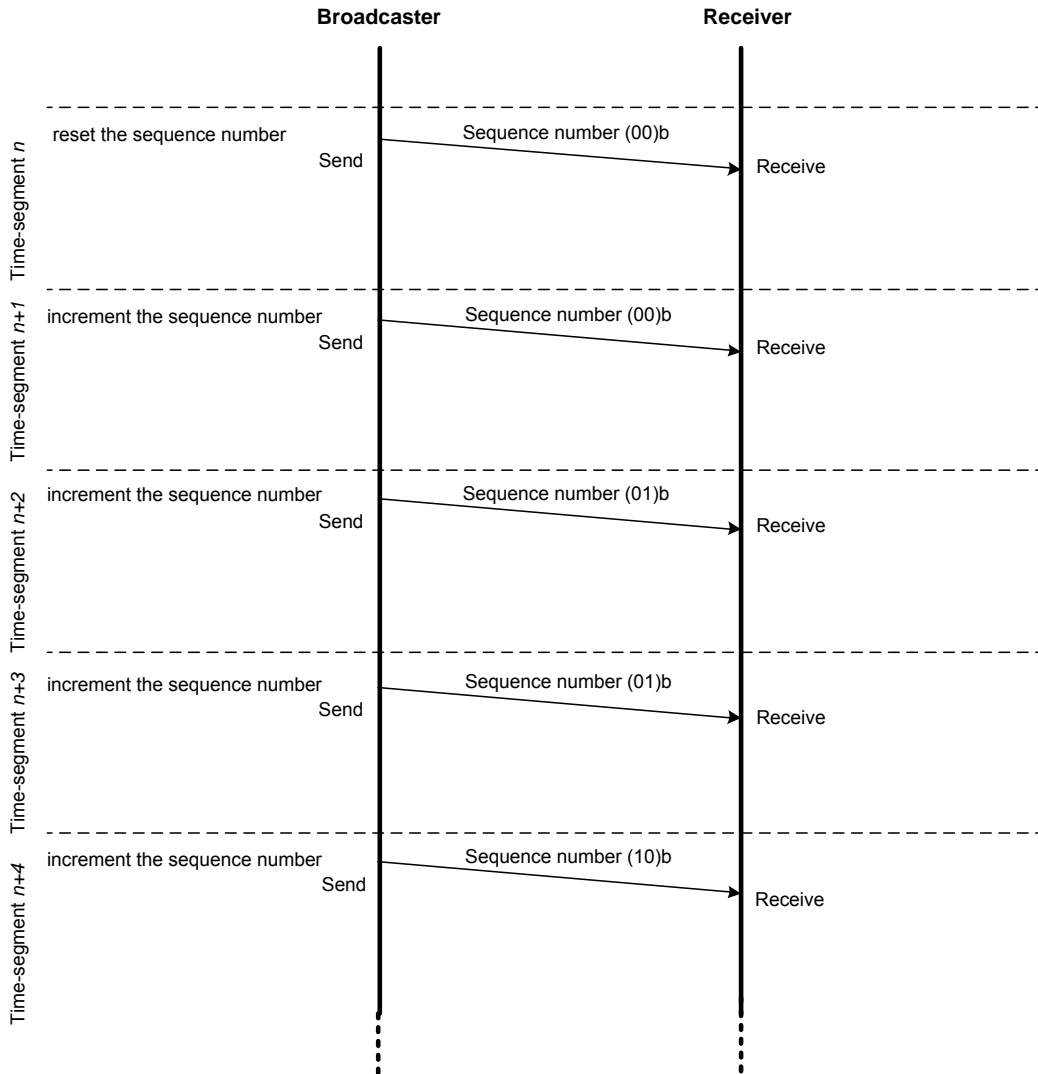

**Figure 15 — Example flow of Broadcast communication**

## Annex A (normative)

### Tests

#### A.1 Reference plate-electrode test

Tests and measurements made to check the requirements of this Standard shall be carried out in the following ambient conditions of the air immediately surrounding the plate-electrode assemblies.

Temperature: 20 °C to 30 °C

Relative humidity: 40 % to 70 %

Conditioning period before testing: at least 1 hour.

The reference plate-electrode assembly shall be horizontally-opposed to the plate-electrode assembly for DUT. The plate-electrodes shall be terminated by a 50  $\Omega$  resistor. See Figure A.1.

The power sources of the Signal Generator and the Spectrum Analyzer shall be electrically isolated from each other.

Any conductive materials without air shall not be in range of 50,0 cm from a plate-electrode assembly. The distance between a plate-electrode assembly and the Signal Generator shall be from 50,0 cm to 100,0 cm. The distance between a plate-electrode assembly and the Spectrum Analyzer shall be from 50,0 cm to 100,0 cm.

The output and input impedance of the Signal Generator and the Spectrum Analyzer and the twisted-pair wire shall be terminated by a 50  $\Omega$  resistor.

The output signal level of the Signal Generator shall be 3,9 dBm of sine wave. The minimum power levels specified in Table A.1 shall be verified at the Spectrum Analyzer for the specified D and distance.

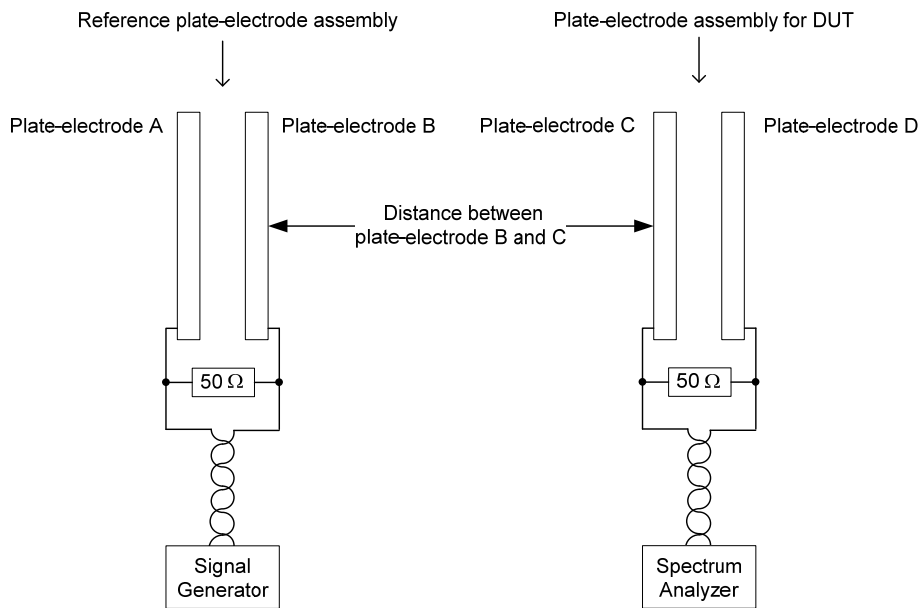

**Figure A.1 — Plate-electrode assembly test**

**Table A.1 — Receive Power (dBm)**

Distance between the Plate-Electrode Assembly (mm)	fc/D (Mb/s)				
	40,68	13,56	8,14	5,81	3,70
1,0 ± 0,5	- 43	- 55	- 60	- 64	- 68
3,2 ± 0,5	- 47	- 58	- 64	- 67	- 72
10,0 ± 0,5	- 55	- 67	- 73	- 76	- 81
31,6 ± 0,5	- 65	- 78	- 84	- 88	- 94
100,0 ± 0,5	- 81	- 93	- 99	- 103	- 108

## A.2 P-PDU DC balance test

The P-PDUs with payloads (00 00 00 00), (FF FF FF FF), (55 55 55 55) and (AA AA AA AA) shall meet the requirements of DC balance of P-PDU, see 8.4.

## A.3 Protocol test

Using the protocol test setup, the tests specified herein shall be completed as specified.

### A.3.1 Test setup

The test setup is illustrated in Figure A.2.

The Test Box shall be able to send and receive the test P-PDUs. The Test Box shall execute all the test scenarios regarding DUT.

The protocol test setup shall consist of Reference plate-electrode assembly, Test box and DUT. The Reference plate-electrode shall be connected to the Test Box. The distance between plate-electrode B and C shall be  $10,0 \pm 0,5$  mm.



The power source of Test Box and DUT shall be electrically insulated each other.

NOTE If Test Box and DUT get power source from the same lamp line then it is not isolated each other and it means their ground connected each other.

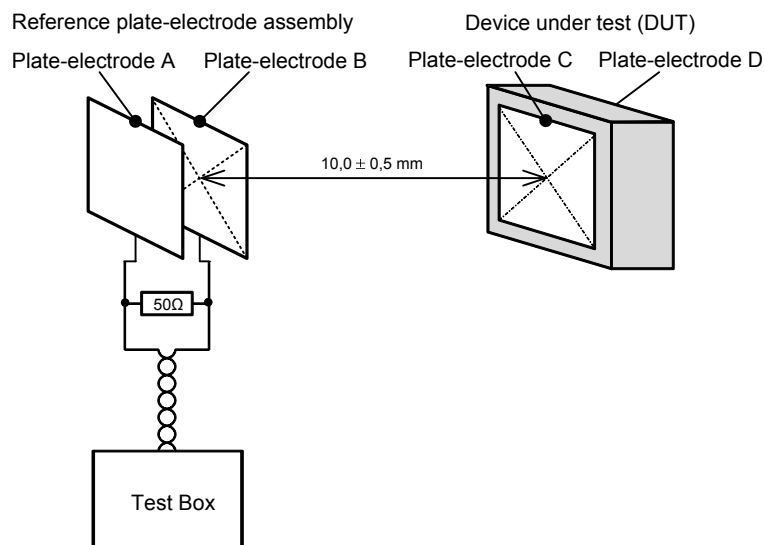

**Figure A.2 — Protocol test setup**

### A.3.2 Test scenario 1

Test Box activates as Talker and DUT activates as Listener.

The devices are tested on FDC0, TDS1 and TDS5 in Full duplex communication with LBT and Association procedure on FDC2, TDS1 and TDS5.

See Table A.2 as detail. Other possible scenarios may be planned.

### A.3.3 Test scenario 2

Test Box activates as Talker and DUT activates as Listener.

The devices are tested on FDC0, TDS1 in Broadcast communication with LBT and Association procedure on FDC2, TDS1 and TDS5.

See Table A.3 as detail. Other possible scenarios may be planned.

### A.3.4 Test scenario 3

Test Box activates as Talker and DUT activates as Listener.

The devices are tested on FDC1, TDS1 and TDS5 in Full duplex communication without Association procedure.

See Table A.4 as detail. Other possible scenarios may be planned.

### A.3.5 Test scenario 4

Test Box activates as Talker and DUT activates as Listener.

The devices are tested on FDC1, TDS1 in Broadcast communication without Association procedure.

See Table A.5 as detail. Other possible scenarios may be planned.

### **A.3.6 Test scenario 5**

Test Box activates as Listener and DUT activates as Talker.

The devices are tested on FDC0, TDS1 and TDS5 in Full duplex communication with LBT and Association procedure on FDC2, TDS1 and TDS5.

See Table A.6 as detail. Other possible scenarios may be planned.

### **A.3.7 Test scenario 6**

Test Box activates as Listener and DUT activates as Talker.

The devices are tested on FDC0, TDS1 in Broadcast communication with LBT and Association procedure on FDC2, TDS1 and TDS5.

See Table A.7 as detail. Other possible scenarios may be planned.

### **A.3.8 Test scenario 7**

Test Box activates as Listener and DUT activates as Talker.

The devices are tested on FDC1, TDS1 and TDS5 in Full duplex communication without Association procedure.

See Table A.8 as detail. Other possible scenarios may be planned.

### **A.3.9 Test scenario 8**

Test Box activates as Listener and DUT activates as Talker.

The devices are tested on FDC1, TDS1 in Broadcast communication without Association procedure.

See Table A.9 as detail. Other possible scenarios may be planned.

**Table A.2 — Test scenario 1**

Test Box with reference plate-electrode assembly	Step number and Direction	Device under test (DUT)
<p>&lt; FDC2/TDS1 : Association Request 1 &gt; Pre-amble/Sync = Pattern P, Attribute = 00, Sequence number = 00, Payload = (20)(00)(E0)(FF)</p> <p>&lt; FDC2/TDS2 : Association Request 1 &gt; Pre-amble/Sync = Pattern P, Attribute = 00, Sequence number = 00, Payload = (00)(00)(00)(00)</p> <p>&lt; FDC2/TDS6 : Association Response 1 &gt; Pre-amble/Sync = Pattern P, Attribute = 00, Sequence number = 01, Payload = (00)(00)(00)(00)</p> <p>&lt; FDC2/TDS3 : Association Request 1 &gt; Pre-amble/Sync = Pattern P, Attribute = 00, Sequence number = 00, Payload = (00)(00)(00)(00)</p> <p>&lt; FDC2/TDS7 : Association Response 1 &gt; Pre-amble/Sync = Pattern P, Attribute = 00, Sequence number = 01, Payload = (00)(00)(00)(00)</p> <p>&lt; FDC2/TDS4 : Association Request 1 &gt; Pre-amble/Sync = Pattern P, Attribute = 00, Sequence number = 00, Payload = (00)(00)(00)(00)</p> <p>&lt; FDC2/TDS8 : Association Response 1 &gt; Pre-amble/Sync = Pattern P, Attribute = 00, Sequence number = 01, Payload = (00)(00)(00)(00)</p> <p>(Test Box sends Association Request 1 or Association Response 1 on TDSs except TDS5 on FDC2. TDS1 : Used FDC1, Talker uses TDS1, Listener uses TDS5, Full duplex)</p>	<p>1 →</p>	<p>&lt; FDC2 : LBT &gt; DUT should be able to detect vacant TDS5 and receive Association Request 1.</p>
	<p>2 ←</p>	<p>&lt; FDC2/TDS5 : Association Response 1 &gt; Pre-amble/Sync = Pattern P, Attribute = 00, Sequence number = 01, Payload = (00)(00)(00)(00)</p>
<p>&lt; FDC2/TDS1 : Association Request 2 &gt; Pre-amble/Sync = Pattern P, Attribute = 01, Sequence number = 10, Payload = (00)(00)(00)(00)</p> <p>&lt; FDC2/TDS2 : Association Request 1 &gt; Pre-amble/Sync = Pattern P, Attribute = 00, Sequence number = 00, Payload = (00)(00)(00)(00)</p> <p>&lt; FDC2/TDS6 : Association Response 1 &gt; Pre-amble/Sync = Pattern P, Attribute = 00, Sequence number = 01, Payload = (00)(00)(00)(00)</p> <p>&lt; FDC2/TDS3 : Association Request 1 &gt; Pre-amble/Sync = Pattern P, Attribute = 00, Sequence number = 00, Payload = (00)(00)(00)(00)</p> <p>&lt; FDC2/TDS7 : Association Response 1 &gt; Pre-amble/Sync = Pattern P, Attribute = 00, Sequence number = 01, Payload = (00)(00)(00)(00)</p> <p>&lt; FDC2/TDS4 : Association Request 1 &gt; Pre-amble/Sync = Pattern P, Attribute = 00, Sequence number = 00, Payload = (00)(00)(00)(00)</p> <p>&lt; FDC2/TDS8 : Association Response 1 &gt; Pre-amble/Sync = Pattern P, Attribute = 00, Sequence number = 01, Payload = (00)(00)(00)(00)</p> <p>(Test Box sends Association Request 2 on FDC2/TDS5 from step 1)</p>	<p>3 →</p>	<p>DUT should be able to receive Association Request 2.</p>
	<p>4 ←</p>	<p>&lt; FDC2/TDS5 : Association Response 2 &gt; Pre-amble/Sync = Pattern P, Attribute = 01, Sequence number = 11, Payload = (20)(00)(E0)(FF)</p> <p>DUT goes to the next step after detecting the silence of P-PDU on FDC2/TDS1.</p>

**Table A.2 — Test scenario 1 (continued)**

<p>&lt; FDC0/TDS1 : Full duplex &gt; Pre-amble/Sync = Pattern P, Attribute = 10, Sequence number = 00, Payload = (0A)(00)(55)(AA)</p> <p>&lt; FDC0/TDS2 : Full duplex &gt; Pre-amble/Sync = Pattern P, Attribute = 00, Sequence number = 00, Payload = (00)(00)(00)(00)</p> <p>&lt; FDC0/TDS6 : Full duplex &gt; Pre-amble/Sync = Pattern P, Attribute = 00, Sequence number = 01, Payload = (00)(00)(00)(00)</p> <p>&lt; FDC0/TDS3 : Full duplex &gt; Pre-amble/Sync = Pattern P, Attribute = 00, Sequence number = 00, Payload = (00)(00)(00)(00)</p> <p>&lt; FDC0/TDS7 : Full duplex &gt; Pre-amble/Sync = Pattern P, Attribute = 00, Sequence number = 01, Payload = (00)(00)(00)(00)</p> <p>&lt; FDC0/TDS4 : Full duplex &gt; Pre-amble/Sync = Pattern P, Attribute = 00, Sequence number = 00, Payload = (00)(00)(00)(00)</p> <p>&lt; FDC0/TDS8 : Full duplex &gt; Pre-amble/Sync = Pattern P, Attribute = 00, Sequence number = 01, Payload = (00)(00)(00)(00)</p> <p>(Test Box sends the first P-DU segment on TDS1 on FDC2)</p>	<p>5 →</p>	<p>DUT should be able to receive the P-DU segment on FDC0/TDS1.</p>
	<p>6 ←</p>	<p>&lt; FDC0/TDS5 : Full duplex &gt; Pre-amble/Sync = Pattern P, Attribute = 10, Sequence number = 01, Payload = (0A)(00)(55)(AA)</p> <p>(DUT send back the payload)</p>
<p>&lt; FDC0/TDS1 : Full duplex &gt; Pre-amble/Sync = Pattern P, Attribute = 11, Sequence number = 10, Payload = (00)(FF)(C3)(E7)</p> <p>&lt; FDC0/TDS2 : Full duplex &gt; Pre-amble/Sync = Pattern P, Attribute = 00, Sequence number = 00, Payload = (00)(00)(00)(00)</p> <p>&lt; FDC0/TDS6 : Full duplex &gt; Pre-amble/Sync = Pattern P, Attribute = 00, Sequence number = 01, Payload = (00)(00)(00)(00)</p> <p>&lt; FDC0/TDS3 : Full duplex &gt; Pre-amble/Sync = Pattern P, Attribute = 00, Sequence number = 00, Payload = (00)(00)(00)(00)</p> <p>&lt; FDC0/TDS7 : Full duplex &gt; Pre-amble/Sync = Pattern P, Attribute = 00, Sequence number = 01, Payload = (00)(00)(00)(00)</p> <p>&lt; FDC0/TDS4 : Full duplex &gt; Pre-amble/Sync = Pattern P, Attribute = 00, Sequence number = 00, Payload = (00)(00)(00)(00)</p> <p>&lt; FDC0/TDS8 : Full duplex &gt; Pre-amble/Sync = Pattern P, Attribute = 00, Sequence number = 01, Payload = (00)(00)(00)(00)</p> <p>(Test Box sends the between P-DU segment on TDS1 on FDC2 from step 4)</p>	<p>7 →</p>	<p>DUT should be able to receive the P-DU segment on FDC0/TDS1.</p>
	<p>8 ←</p>	<p>&lt; FDC0/TDS5 : Full duplex &gt; Pre-amble/Sync = Pattern P, Attribute = 11, Sequence number = 11, Payload = (00)(FF)(C3)(E7)</p> <p>(DUT send back the payload)</p>

**Table A.2 — Test scenario 1 (concluded)**

<p>&lt; FDC0/TDS1 : Full duplex &gt;          Pre-amble/Sync = Pattern P, Attribute = 01,          Sequence number = 00, Payload = (96)(42)(B0)(4A)</p> <p>&lt; FDC0/TDS2 : Full duplex &gt;          Pre-amble/Sync = Pattern P, Attribute = 00,          Sequence number = 00, Payload = (00)(00)(00)(00)</p> <p>&lt; FDC0/TDS6 : Full duplex &gt;          Pre-amble/Sync = Pattern P, Attribute = 00,          Sequence number = 01, Payload = (00)(00)(00)(00)</p> <p>&lt; FDC0/TDS3 : Full duplex &gt;          Pre-amble/Sync = Pattern P, Attribute = 00,          Sequence number = 00, Payload = (00)(00)(00)(00)</p> <p>&lt; FDC0/TDS7 : Full duplex &gt;          Pre-amble/Sync = Pattern P, Attribute = 00,          Sequence number = 01, Payload = (00)(00)(00)(00)</p> <p>&lt; FDC0/TDS4 : Full duplex &gt;          Pre-amble/Sync = Pattern P, Attribute = 00,          Sequence number = 00, Payload = (00)(00)(00)(00)</p> <p>&lt; FDC0/TDS8 : Full duplex &gt;          Pre-amble/Sync = Pattern P, Attribute = 00,          Sequence number = 01, Payload = (00)(00)(00)(00)</p> <p>(Test Box sends Full duplex P-PDU on TDS5 on FDC2 from step 4)</p>	<p>9 →</p>	<p>DUT should be able to receive the P-DU segment on FDC0/TDS1.</p>
	<p>10 ←</p>	<p>&lt; FDC0/TDS5 : Full duplex &gt;          Pre-amble/Sync = Pattern P, Attribute = 01,          Sequence number = 01, Payload = (96)(42)(B0)(4A)</p> <p>(DUT send back the payload)</p>

**Table A.3 — Test scenario 2**

Test Box with reference plate-electrode assembly	Step number and Direction	Device under test (DUT)
<p>&lt; FDC2/TDS1 : Association Request 1 &gt; Pre-amble/Sync = Pattern P, Attribute = 00, Sequence number = 00, Payload = (00)(02)(00)(FE)</p> <p>&lt; FDC2/TDS2 : Association Request 1 &gt; Pre-amble/Sync = Pattern P, Attribute = 00, Sequence number = 00, Payload = (00)(00)(00)(00)</p> <p>&lt; FDC2/TDS6 : Association Response 1 &gt; Pre-amble/Sync = Pattern P, Attribute = 00, Sequence number = 01, Payload = (00)(00)(00)(00)</p> <p>&lt; FDC2/TDS3 : Association Request 1 &gt; Pre-amble/Sync = Pattern P, Attribute = 00, Sequence number = 00, Payload = (00)(00)(00)(00)</p> <p>&lt; FDC2/TDS7 : Association Response 1 &gt; Pre-amble/Sync = Pattern P, Attribute = 00, Sequence number = 01, Payload = (00)(00)(00)(00)</p> <p>&lt; FDC2/TDS4 : Association Request 1 &gt; Pre-amble/Sync = Pattern P, Attribute = 00, Sequence number = 00, Payload = (00)(00)(00)(00)</p> <p>&lt; FDC2/TDS8 : Association Response 1 &gt; Pre-amble/Sync = Pattern P, Attribute = 00, Sequence number = 01, Payload = (00)(00)(00)(00)</p> <p>(Test Box sends Association Request 1 or Association Response 1 on TDSs except TDS1 and TDS5 on FDC2. TDS1 : Used FDC1, Talker uses TDS1, Listener uses TDS5, Full duplex)</p>	<p>1 →</p>	<p>&lt; FDC2 : LBT &gt; DUT should be able to detect the vacant TDS5 on FDC2 and receive Association Request 1.</p>
	<p>2 ←</p>	<p>&lt; FDC2/TDS5 : Association Response 1 &gt; Pre-amble/Sync = Pattern P, Attribute = 00, Sequence number = 01, Payload = (00)(00)(00)(00)</p>
<p>&lt; FDC2/TDS1 : Association Request 2 &gt; Pre-amble/Sync = Pattern P, Attribute = 01, Sequence number = 10, Payload = (00)(00)(00)(00)</p> <p>&lt; FDC2/TDS2 : Association Request 1 &gt; Pre-amble/Sync = Pattern P, Attribute = 00, Sequence number = 00, Payload = (00)(00)(00)(00)</p> <p>&lt; FDC2/TDS6 : Association Response 1 &gt; Pre-amble/Sync = Pattern P, Attribute = 00, Sequence number = 01, Payload = (00)(00)(00)(00)</p> <p>&lt; FDC2/TDS3 : Association Request 1 &gt; Pre-amble/Sync = Pattern P, Attribute = 00, Sequence number = 00, Payload = (00)(00)(00)(00)</p> <p>&lt; FDC2/TDS7 : Association Response 1 &gt; Pre-amble/Sync = Pattern P, Attribute = 00, Sequence number = 01, Payload = (00)(00)(00)(00)</p> <p>&lt; FDC2/TDS4 : Association Request 1 &gt; Pre-amble/Sync = Pattern P, Attribute = 00, Sequence number = 00, Payload = (00)(00)(00)(00)</p> <p>&lt; FDC2/TDS8 : Association Response 1 &gt; Pre-amble/Sync = Pattern P, Attribute = 00, Sequence number = 01, Payload = (00)(00)(00)(00)</p> <p>(Test Box sends Association Response 1 on FDC2/TDS5 from step 1)</p>	<p>3 →</p>	<p>DUT should be able to receive Association Request 1.</p>

**Table A.3 — Test scenario 2 (continued)**

	<p>4 ←</p>	<p>&lt; FDC2/TDS5 : Association Response 2 &gt; Pre-amble/Sync = Pattern P, Attribute = 01, Sequence number = 11, Payload = (00)(02)(00)(FE)</p> <p>DUT goes to the next step after detecting the silence of P-PDU on FDC2/TDS1.</p>
<p>&lt; FDC0/TDS1 : Broadcast &gt; Pre-amble/Sync = Pattern P, Attribute = 10, Sequence number = 00, Payload = (0A)(00)(55)(AA) ● Check iteration count function (Test Box sends the first P-DU segment iteration count times)</p> <p>&lt; FDC0/TDS2 : Broadcast &gt; Pre-amble/Sync = Pattern P, Attribute = 00, Sequence number = 00, Payload = (00)(00)(00)(00)</p> <p>&lt; FDC0/TDS3 : Broadcast &gt; Pre-amble/Sync = Pattern P, Attribute = 00, Sequence number = 00, Payload = (00)(00)(00)(00)</p> <p>&lt; FDC0/TDS4 : Broadcast &gt; Pre-amble/Sync = Pattern P, Attribute = 00, Sequence number = 00, Payload = (00)(00)(00)(00)</p> <p>&lt; FDC0/TDS5 : Broadcast &gt; Pre-amble/Sync = Pattern P, Attribute = 00, Sequence number = 00, Payload = (00)(00)(00)(00)</p> <p>&lt; FDC0/TDS6 : Broadcast &gt; Pre-amble/Sync = Pattern P, Attribute = 00, Sequence number = 00, Payload = (00)(00)(00)(00)</p> <p>&lt; FDC0/TDS7 : Broadcast &gt; Pre-amble/Sync = Pattern P, Attribute = 00, Sequence number = 00, Payload = (00)(00)(00)(00)</p> <p>&lt; FDC0/TDS8 : Broadcast &gt; Pre-amble/Sync = Pattern P, Attribute = 00, Sequence number = 00, Payload = (00)(00)(00)(00)</p>	<p>5 →</p>	<p>DUT should be able to receive the P-DU segment on FDC0/TDS1 for iteration count.</p>
<p>&lt; FDC0/TDS1 : Broadcast &gt; Pre-amble/Sync = Pattern P, Attribute = 11, Sequence number = 01, Payload = (00)(FF)(C3)(E7) ● Check iteration count function (Test Box sends the between P-DU segment iteration count times)</p> <p>&lt; FDC0/TDS2 : Broadcast &gt; Pre-amble/Sync = Pattern P, Attribute = 00, Sequence number = 00, Payload = (00)(00)(00)(00)</p> <p>&lt; FDC0/TDS3 : Broadcast &gt; Pre-amble/Sync = Pattern P, Attribute = 00, Sequence number = 00, Payload = (00)(00)(00)(00)</p> <p>&lt; FDC0/TDS4 : Broadcast &gt; Pre-amble/Sync = Pattern P, Attribute = 00, Sequence number = 00, Payload = (00)(00)(00)(00)</p> <p>&lt; FDC0/TDS5 : Broadcast &gt; Pre-amble/Sync = Pattern P, Attribute = 00, Sequence number = 00, Payload = (00)(00)(00)(00)</p> <p>&lt; FDC0/TDS6 : Broadcast &gt; Pre-amble/Sync = Pattern P, Attribute = 00, Sequence number = 00, Payload = (00)(00)(00)(00)</p> <p>&lt; FDC0/TDS7 : Broadcast &gt; Pre-amble/Sync = Pattern P, Attribute = 00, Sequence number = 00, Payload = (00)(00)(00)(00)</p> <p>&lt; FDC0/TDS8 : Broadcast &gt; Pre-amble/Sync = Pattern P, Attribute = 00, Sequence number = 00, Payload = (00)(00)(00)(00)</p>	<p>6 →</p>	<p>DUT should be able to receive the P-DU segment on FDC0/TDS1 for iteration count.</p>

**Table A.3 — Test scenario 2 (concluded)**

<p>&lt; FDC0/TDS1 Full duplex &gt;          Pre-amble/Sync = Pattern P, Attribute = 01,          Sequence number = 10, Payload = (96)(42)(B0)(4A)          ● Check iteration count function          (Test Box sends the last P-DU segment iteration count times)</p> <p>&lt; FDC0/TDS2 : Broadcast &gt;          Pre-amble/Sync = Pattern P, Attribute = 00,          Sequence number = 00, Payload = (00)(00)(00)(00)</p> <p>&lt; FDC0/TDS3 : Broadcast &gt;          Pre-amble/Sync = Pattern P, Attribute = 00,          Sequence number = 00, Payload = (00)(00)(00)(00)</p> <p>&lt; FDC0/TDS4 : Broadcast &gt;          Pre-amble/Sync = Pattern P, Attribute = 00,          Sequence number = 00, Payload = (00)(00)(00)(00)</p> <p>&lt; FDC0/TDS5 : Broadcast &gt;          Pre-amble/Sync = Pattern P, Attribute = 00,          Sequence number = 00, Payload = (00)(00)(00)(00)</p> <p>&lt; FDC0/TDS6 : Broadcast &gt;          Pre-amble/Sync = Pattern P, Attribute = 00,          Sequence number = 00, Payload = (00)(00)(00)(00)</p> <p>&lt; FDC0/TDS7 : Broadcast &gt;          Pre-amble/Sync = Pattern P, Attribute = 00,          Sequence number = 00, Payload = (00)(00)(00)(00)</p> <p>&lt; FDC0/TDS8 : Broadcast &gt;          Pre-amble/Sync = Pattern P, Attribute = 00,          Sequence number = 00, Payload = (00)(00)(00)(00)</p>	<p>7          →</p>	<p>DUT should be able to receive the P-DU segment on FDC0/TDS1 for iteration count.</p>
---	-------------------------	---



**Table A.4 — Test scenario 3**

Test Box with reference plate-electrode assembly	Step number and Direction	Device under test (DUT)
<p>&lt; FDC1/TDS1 : Full duplex &gt; Pre-amble/Sync = Pattern P, Attribute = 10, Sequence number = 00, Payload = (0A)(00)(55)(AA)</p> <p>&lt; FDC1/TDS2 : Full duplex &gt; Pre-amble/Sync = Pattern P, Attribute = 00, Sequence number = 00, Payload = (00)(00)(00)(00)</p> <p>&lt; FDC1/TDS6 : Full duplex &gt; Pre-amble/Sync = Pattern P, Attribute = 00, Sequence number = 01, Payload = (00)(00)(00)(00)</p> <p>&lt; FDC1/TDS3 : Full duplex &gt; Pre-amble/Sync = Pattern P, Attribute = 00, Sequence number = 00, Payload = (00)(00)(00)(00)</p> <p>&lt; FDC1/TDS7 : Full duplex &gt; Pre-amble/Sync = Pattern P, Attribute = 00, Sequence number = 01, Payload = (00)(00)(00)(00)</p> <p>&lt; FDC1/TDS4 : Full duplex &gt; Pre-amble/Sync = Pattern P, Attribute = 00, Sequence number = 00, Payload = (00)(00)(00)(00)</p> <p>&lt; FDC1/TDS8 : Full duplex &gt; Pre-amble/Sync = Pattern P, Attribute = 00, Sequence number = 01, Payload = (00)(00)(00)(00)</p> <p>(Test Box sends the first P-DU segment on TDS1 except on FDC0)</p>	<p>1 →</p>	<p>Supposing that DUT knows TDS5 as own time-slot. DUT should be able to receive the P-DU segment on FDC0/TDS1.</p>
	<p>2 ←</p>	<p>&lt; FDC1/TDS5 : Full duplex &gt; Pre-amble/Sync = Pattern P, Attribute = 00, Sequence number = 01, Payload = (0A)(00)(55)(AA)</p> <p>(DUT send back the payload)</p>
<p>&lt; FDC1/TDS1 : Full duplex &gt; Pre-amble/Sync = Pattern P, Attribute = 11, Sequence number = 10, Payload = (00)(FF)(C3)(E7)</p> <p>&lt; FDC1/TDS2 : Full duplex &gt; Pre-amble/Sync = Pattern P, Attribute = 00, Sequence number = 00, Payload = (00)(00)(00)(00)</p> <p>&lt; FDC1/TDS6 : Full duplex &gt; Pre-amble/Sync = Pattern P, Attribute = 00, Sequence number = 01, Payload = (00)(00)(00)(00)</p> <p>&lt; FDC1/TDS3 : Full duplex &gt; Pre-amble/Sync = Pattern P, Attribute = 00, Sequence number = 00, Payload = (00)(00)(00)(00)</p> <p>&lt; FDC1/TDS7 : Full duplex &gt; Pre-amble/Sync = Pattern P, Attribute = 00, Sequence number = 01, Payload = (00)(00)(00)(00)</p> <p>&lt; FDC1/TDS4 : Full duplex &gt; Pre-amble/Sync = Pattern P, Attribute = 00, Sequence number = 00, Payload = (00)(00)(00)(00)</p> <p>&lt; FDC1/TDS8 : Full duplex &gt; Pre-amble/Sync = Pattern P, Attribute = 00, Sequence number = 01, Payload = (00)(00)(00)(00)</p> <p>(Test Box sends Full duplex P-PDU on TDS5 on FDC2 from step 4)</p>	<p>3 →</p>	<p>DUT should be able to receive the P-DU segment on FDC0/TDS1.</p>
	<p>4 ←</p>	<p>&lt; FDC1/TDS5 : Full duplex &gt; Pre-amble/Sync = Pattern P, Attribute = 11, Sequence number = 11, Payload = (00)(FF)(C3)(E7)</p> <p>(DUT send back the payload)</p>

**Table A.4 — Test scenario 3 (concluded)**

<p>&lt; FDC1/TDS1 : Full duplex &gt; Pre-amble/Sync = Pattern P, Attribute = 01, Sequence number = 00, Payload = (96)(42)(B0)(4A)</p> <p>&lt; FDC1/TDS2 : Full duplex &gt; Pre-amble/Sync = Pattern P, Attribute = 00, Sequence number = 00, Payload = (00)(00)(00)(00)</p> <p>&lt; FDC1/TDS6 : Full duplex &gt; Pre-amble/Sync = Pattern P, Attribute = 00, Sequence number = 01, Payload = (00)(00)(00)(00)</p> <p>&lt; FDC1/TDS3 : Full duplex &gt; Pre-amble/Sync = Pattern P, Attribute = 00, Sequence number = 00, Payload = (00)(00)(00)(00)</p> <p>&lt; FDC1/TDS7 : Full duplex &gt; Pre-amble/Sync = Pattern P, Attribute = 00, Sequence number = 01, Payload = (00)(00)(00)(00)</p> <p>&lt; FDC1/TDS4 : Full duplex &gt; Pre-amble/Sync = Pattern P, Attribute = 00, Sequence number = 00, Payload = (00)(00)(00)(00)</p> <p>&lt; FDC1/TDS8 : Full duplex &gt; Pre-amble/Sync = Pattern P, Attribute = 00, Sequence number = 01, Payload = (00)(00)(00)(00)</p> <p>(Test Box sends Full duplex P-PDU on TDS5 on FDC2 from step 4)</p>	<p>5 →</p>	<p>DUT should be able to receive the P-DU segment on FDC0/TDS1.</p>
	<p>6 ←</p>	<p>&lt; FDC1/TDS5 : Full duplex &gt; Pre-amble/Sync = Pattern P, Attribute = 01, Sequence number = 01, Payload = (96)(42)(B0)(4A)</p> <p>(DUT send back the payload)</p>

**Table A.5 — Test scenario 4**

Test Box with reference plate-electrode assembly	Step number and Direction	Device under test (DUT)
<p>&lt; FDC1/TDS1 : Broadcast &gt; Pre-amble/Sync = Pattern P, Attribute = 10, Sequence number = 00, Payload = (0A)(00)(55)(AA)</p> <ul style="list-style-type: none"> <li>● Check iteration count function</li> </ul> <p>(Test Box sends the first P-DU segment iteration count times)</p>	<p>1 →</p>	<p>(Test Box sends same P-PDUs and DUT checks to receive the P-PDU from Test Box with iteration count)</p>
<p>&lt; FDC1/TDS1 : Broadcast &gt; Pre-amble/Sync = Pattern P, Attribute = 11, Sequence number = 01, Payload = (00)(FF)(C3)(E7)</p> <ul style="list-style-type: none"> <li>● Check iteration count function</li> </ul> <p>(Test Box sends the between P-DU segment iteration count times)</p>	<p>2 →</p>	<p>(Test Box sends same P-PDUs and DUT checks to receive the P-PDU from Test Box with iteration count)</p>
<p>&lt; FDC1/TDS1 : Broadcast &gt; Pre-amble/Sync = Pattern P, Attribute = 01, Sequence number = 10, Payload = (96)(42)(B0)(4A)</p> <ul style="list-style-type: none"> <li>● Check iteration count function</li> </ul> <p>(Test Box sends the last P-DU segment iteration count times)</p>	<p>3 →</p>	<p>(Test Box sends same P-PDUs and DUT checks to receive the P-PDU from Test Box with iteration count)</p>

**Table A.6 — Test scenario 5**

Test Box with reference plate-electrode assembly	Step number and Direction	Device under test (DUT)
<p>&lt; FDC2/TDS1 : Association Request 1 &gt; Pre-amble/Sync = Pattern P, Attribute = 00, Sequence number = 00, Payload = (00)(00)(00)(00)</p> <p>&lt; FDC2/TDS5 : Association Response 1 &gt; Pre-amble/Sync = Pattern P, Attribute = 00, Sequence number = 01, Payload = (00)(00)(00)(00)</p> <p>&lt; FDC2/TDS2 : Association Request 1 &gt; Pre-amble/Sync = Pattern P, Attribute = 00, Sequence number = 00, Payload = (00)(00)(00)(00)</p> <p>&lt; FDC2/TDS6 : Association Response 1 &gt; Pre-amble/Sync = Pattern P, Attribute = 00, Sequence number = 01, Payload = (00)(00)(00)(00)</p> <p>&lt; FDC2/TDS3 : Association Request 1 &gt; Pre-amble/Sync = Pattern P, Attribute = 00, Sequence number = 00, Payload = (00)(00)(00)(00)</p> <p>&lt; FDC2/TDS7 : Association Response 1 &gt; Pre-amble/Sync = Pattern P, Attribute = 00, Sequence number = 01, Payload = (00)(00)(00)(00)</p> <p>&lt; FDC2/TDS4 : Association Request 1 &gt; Pre-amble/Sync = Pattern P, Attribute = 00, Sequence number = 00, Payload = (00)(00)(00)(00)</p> <p>&lt; FDC2/TDS8 : Association Response 1 &gt; Pre-amble/Sync = Pattern P, Attribute = 00, Sequence number = 01, Payload = (00)(00)(00)(00)</p> <p>(Test Box sends Association Request 1 or Association Response 1 on all TDSs on FDC3)</p>	<p>1 →</p>	<p>&lt; FDC2 : LBT &gt; DUT should be able to detect all occupied TDSs on FDC2.</p>
<p>&lt; FDC0/TDS1 : Full duplex &gt; Pre-amble/Sync = Pattern P, Attribute = 00, Sequence number = 00, Payload = (00)(00)(00)(00)</p> <p>&lt; FDC0/TDS5 : Full duplex &gt; Pre-amble/Sync = Pattern P, Attribute = 00, Sequence number = 01, Payload = (00)(00)(00)(00)</p> <p>&lt; FDC0/TDS2 : Full duplex &gt; Pre-amble/Sync = Pattern P, Attribute = 00, Sequence number = 00, Payload = (00)(00)(00)(00)</p> <p>&lt; FDC0/TDS6 : Full duplex &gt; Pre-amble/Sync = Pattern P, Attribute = 00, Sequence number = 01, Payload = (00)(00)(00)(00)</p> <p>&lt; FDC0/TDS3 : Full duplex &gt; Pre-amble/Sync = Pattern P, Attribute = 00, Sequence number = 00, Payload = (00)(00)(00)(00)</p> <p>&lt; FDC0/TDS7 : Full duplex &gt; Pre-amble/Sync = Pattern P, Attribute = 00, Sequence number = 01, Payload = (00)(00)(00)(00)</p> <p>&lt; FDC0/TDS4 : Full duplex &gt; Pre-amble/Sync = Pattern P, Attribute = 00, Sequence number = 00, Payload = (00)(00)(00)(00)</p> <p>&lt; FDC0/TDS8 : Full duplex &gt; Pre-amble/Sync = Pattern P, Attribute = 00, Sequence number = 01, Payload = (00)(00)(00)(00)</p> <p>(Test Box sends Full duplex P-PDUs on all TDSs on FDC0)</p>	<p>2 →</p>	<p>&lt; FDC0 : LBT &gt; DUT should be able to detect all occupied TDSs on FDC0.</p>

**Table A.6 — Test scenario 5 (continued)**

<p>&lt; FDC2/TDS2 : Association Request 1 &gt; Pre-amble/Sync = Pattern P, Attribute = 00, Sequence number = 00, Payload = (00)(00)(00)(00)</p> <p>&lt; FDC2/TDS6 : Association Response 1 &gt; Pre-amble/Sync = Pattern P, Attribute = 00, Sequence number = 01, Payload = (00)(00)(00)(00)</p> <p>&lt; FDC2/TDS3 : Association Request 1 &gt; Pre-amble/Sync = Pattern P, Attribute = 00, Sequence number = 00, Payload = (00)(00)(00)(00)</p> <p>&lt; FDC2/TDS7 : Association Response 1 &gt; Pre-amble/Sync = Pattern P, Attribute = 00, Sequence number = 01, Payload = (00)(00)(00)(00)</p> <p>&lt; FDC2/TDS4 : Association Request 1 &gt; Pre-amble/Sync = Pattern P, Attribute = 00, Sequence number = 00, Payload = (00)(00)(00)(00)</p> <p>&lt; FDC2/TDS8 : Association Response 1 &gt; Pre-amble/Sync = Pattern P, Attribute = 00, Sequence number = 01, Payload = (00)(00)(00)(00)</p> <p>(Test Box sends Association Request 1 or Association Response 1 on TDSs except TDS1 and TDS5 on FDC2)</p>	<p>3 →</p>	<p>&lt; FDC2 : LBT &gt; DUT should be able to detect the vacant TDS1 and TDS5 on FDC2.</p>
<p>&lt; FDC0/TDS2 : Full duplex &gt; Pre-amble/Sync = Pattern P, Attribute = 00, Sequence number = 00, Payload = (00)(00)(00)(00)</p> <p>&lt; FDC0/TDS6 : Full duplex &gt; Pre-amble/Sync = Pattern P, Attribute = 00, Sequence number = 01, Payload = (00)(00)(00)(00)</p> <p>&lt; FDC0/TDS3 : Full duplex &gt; Pre-amble/Sync = Pattern P, Attribute = 00, Sequence number = 00, Payload = (00)(00)(00)(00)</p> <p>&lt; FDC0/TDS7 : Full duplex &gt; Pre-amble/Sync = Pattern P, Attribute = 00, Sequence number = 01, Payload = (00)(00)(00)(00)</p> <p>&lt; FDC0/TDS4 : Full duplex &gt; Pre-amble/Sync = Pattern P, Attribute = 00, Sequence number = 00, Payload = (00)(00)(00)(00)</p> <p>&lt; FDC0/TDS8 : Full duplex &gt; Pre-amble/Sync = Pattern P, Attribute = 00, Sequence number = 01, Payload = (00)(00)(00)(00)</p> <p>(Test Box sends Full duplex P-PDUs on TDSs except TDS1 and TDS5 on FDC0)</p>	<p>4 →</p>	<p>&lt; FDC0 : LBT &gt; DUT should be able to detect the vacant TDS1 and TDS5 on FDC0.</p>
	<p>5 ←</p>	<p>&lt; FDC2/TDS1 : Association Request 1 &gt; Pre-amble/Sync = Pattern P, Attribute = 00, Sequence number = 00, Payload = (20)(00)(E0)(FF) (Used FDC0, Talker uses TDS1, Listener uses TDS5, Full duplex)</p>

**Table A.6 — Test scenario 5 (continued)**

<p>&lt; FDC2/TDS5 : Association Response 1 &gt; Pre-amble/Sync = Pattern P, Attribute = 00, Sequence number = 01, Payload = (00)(00)(00)(00)</p> <p>&lt; FDC2/TDS2 : Association Request 1 &gt; Pre-amble/Sync = Pattern P, Attribute = 00, Sequence number = 00, Payload = (00)(00)(00)(00)</p> <p>&lt; FDC2/TDS6 : Association Response 1 &gt; Pre-amble/Sync = Pattern P, Attribute = 00, Sequence number = 01, Payload = (00)(00)(00)(00)</p> <p>&lt; FDC2/TDS3 : Association Request 1 &gt; Pre-amble/Sync = Pattern P, Attribute = 00, Sequence number = 00, Payload = (00)(00)(00)(00)</p> <p>&lt; FDC2/TDS7 : Association Response 1 &gt; Pre-amble/Sync = Pattern P, Attribute = 00, Sequence number = 01, Payload = (00)(00)(00)(00)</p> <p>&lt; FDC2/TDS4 : Association Request 1 &gt; Pre-amble/Sync = Pattern P, Attribute = 00, Sequence number = 00, Payload = (00)(00)(00)(00)</p> <p>&lt; FDC2/TDS8 : Association Response 1 &gt; Pre-amble/Sync = Pattern P, Attribute = 00, Sequence number = 01, Payload = (00)(00)(00)(00)</p> <p>(Test Box sends Association Response 1 on FDC2/TDS5 from step 4)</p>	<p>6 →</p>	<p>DUT should be able to receive Association Response 1.</p>
	<p>7 ←</p>	<p>&lt; FDC2/TDS1 : Association Request 2 &gt; Pre-amble/Sync = Pattern P, Attribute = 01, Sequence number = 10, Payload = (00)(00)(00)(00)</p>
<p>&lt; FDC2/TDS5 : Association Response 2 &gt; Pre-amble/Sync = Pattern P, Attribute = 01, Sequence number = 11, Payload = (20)(00)(E0)(FF)</p> <p>&lt; FDC2/TDS2 : Association Request 1 &gt; Pre-amble/Sync = Pattern P, Attribute = 00, Sequence number = 00, Payload = (00)(00)(00)(00)</p> <p>&lt; FDC2/TDS6 : Association Response 1 &gt; Pre-amble/Sync = Pattern P, Attribute = 00, Sequence number = 01, Payload = (00)(00)(00)(00)</p> <p>&lt; FDC2/TDS3 : Association Request 1 &gt; Pre-amble/Sync = Pattern P, Attribute = 00, Sequence number = 00, Payload = (00)(00)(00)(00)</p> <p>&lt; FDC2/TDS7 : Association Response 1 &gt; Pre-amble/Sync = Pattern P, Attribute = 00, Sequence number = 01, Payload = (00)(00)(00)(00)</p> <p>&lt; FDC2/TDS4 : Association Request 1 &gt; Pre-amble/Sync = Pattern P, Attribute = 00, Sequence number = 00, Payload = (00)(00)(00)(00)</p> <p>&lt; FDC2/TDS8 : Association Response 1 &gt; Pre-amble/Sync = Pattern P, Attribute = 00, Sequence number = 01, Payload = (00)(00)(00)(00)</p> <p>(Test Box sends Association Response 2 on FDC2/TDS5 from step 4)</p>	<p>8 →</p>	<p>DUT should be able to receive Association Response 2.</p>
	<p>9 ←</p>	<p>&lt; FDC0/TDS1 : Full duplex &gt; Pre-amble/Sync = Pattern P, Attribute = 10, Sequence number = 00, Payload = (0A)(00)(55)(AA)</p> <p>(DUT sends the first P-DU segment)</p>

**Table A.6 — Test scenario 5 (continued)**

<p>&lt; FDC0/TDS5 : Full duplex &gt; Pre-amble/Sync = Pattern P, Attribute = 00, Sequence number = 01, Payload = (0A)(00)(55)(AA)</p> <p>&lt; FDC0/TDS2 : Full duplex &gt; Pre-amble/Sync = Pattern P, Attribute = 00, Sequence number = 00, Payload = (00)(00)(00)(00)</p> <p>&lt; FDC0/TDS6 : Full duplex &gt; Pre-amble/Sync = Pattern P, Attribute = 00, Sequence number = 01, Payload = (00)(00)(00)(00)</p> <p>&lt; FDC0/TDS3 : Full duplex &gt; Pre-amble/Sync = Pattern P, Attribute = 00, Sequence number = 00, Payload = (00)(00)(00)(00)</p> <p>&lt; FDC0/TDS7 : Full duplex &gt; Pre-amble/Sync = Pattern P, Attribute = 00, Sequence number = 01, Payload = (00)(00)(00)(00)</p> <p>&lt; FDC0/TDS4 : Full duplex &gt; Pre-amble/Sync = Pattern P, Attribute = 00, Sequence number = 00, Payload = (00)(00)(00)(00)</p> <p>&lt; FDC0/TDS8 : Full duplex &gt; Pre-amble/Sync = Pattern P, Attribute = 00, Sequence number = 01, Payload = (00)(00)(00)(00)</p> <p>(Test Box sends Full duplex P-PDUs on TDS5 on FDC2 from step 4)</p>	<p>10 →</p>	<p>DUT should be able to receive Full duplex P-DPU on FDC0/TDS5.</p>
	<p>11 ←</p>	<p>&lt; FDC0/TDS1 Full duplex &gt; Pre-amble/Sync = Pattern P, Attribute = 11, Sequence number = 10, Payload = (00)(FF)(C3)(E7)</p> <p>(DUT sends the between P-DU segment)</p>
<p>&lt; FDC0/TDS5 : Full duplex &gt; Pre-amble/Sync = Pattern P, Attribute = 11, Sequence number = 11, Payload = (00)(FF)(C3)(E7)</p> <p>&lt; FDC0/TDS2 : Full duplex &gt; Pre-amble/Sync = Pattern P, Attribute = 00, Sequence number = 00, Payload = (00)(00)(00)(00)</p> <p>&lt; FDC0/TDS6 : Full duplex &gt; Pre-amble/Sync = Pattern P, Attribute = 00, Sequence number = 01, Payload = (00)(00)(00)(00)</p> <p>&lt; FDC0/TDS3 : Full duplex &gt; Pre-amble/Sync = Pattern P, Attribute = 00, Sequence number = 00, Payload = (00)(00)(00)(00)</p> <p>&lt; FDC0/TDS7 : Full duplex &gt; Pre-amble/Sync = Pattern P, Attribute = 00, Sequence number = 01, Payload = (00)(00)(00)(00)</p> <p>&lt; FDC0/TDS4 : Full duplex &gt; Pre-amble/Sync = Pattern P, Attribute = 00, Sequence number = 00, Payload = (00)(00)(00)(00)</p> <p>&lt; FDC0/TDS8 : Full duplex &gt; Pre-amble/Sync = Pattern P, Attribute = 00, Sequence number = 01, Payload = (00)(00)(00)(00)</p> <p>(Test Box sends Full duplex P-PDUs on TDS5 on FDC2 from step 4)</p>	<p>12 →</p>	<p>DUT should be able to receive Full duplex P-DPU on FDC0/TDS5.</p>
	<p>13 ←</p>	<p>&lt; FDC0/TDS1 : Full duplex &gt; Pre-amble/Sync = Pattern P, Attribute = 01, Sequence number = 00, Payload = (96)(42)(B0)(4A)</p> <p>(DUT sends the last P-DU segment)</p>

**Table A.6 — Test scenario 5 (concluded)**

<p>&lt; FDC0/TDS5 : Full duplex &gt;          Pre-amble/Sync = Pattern P, Attribute = 01,          Sequence number = 01, Payload = (96)(42)(B0)(4A)</p> <p>&lt; FDC0/TDS2 : Full duplex &gt;          Pre-amble/Sync = Pattern P, Attribute = 00,          Sequence number = 00, Payload = (00)(00)(00)(00)</p> <p>&lt; FDC0/TDS6 : Full duplex &gt;          Pre-amble/Sync = Pattern P, Attribute = 00,          Sequence number = 01, Payload = (00)(00)(00)(00)</p> <p>&lt; FDC0/TDS3 : Full duplex &gt;          Pre-amble/Sync = Pattern P, Attribute = 00,          Sequence number = 00, Payload = (00)(00)(00)(00)</p> <p>&lt; FDC0/TDS7 : Full duplex &gt;          Pre-amble/Sync = Pattern P, Attribute = 00,          Sequence number = 01, Payload = (00)(00)(00)(00)</p> <p>&lt; FDC0/TDS4 : Full duplex &gt;          Pre-amble/Sync = Pattern P, Attribute = 00,          Sequence number = 00, Payload = (00)(00)(00)(00)</p> <p>&lt; FDC0/TDS8 : Full duplex &gt;          Pre-amble/Sync = Pattern P, Attribute = 00,          Sequence number = 01, Payload = (00)(00)(00)(00)</p> <p>(Test Box sends Full duplex P-PDU on TDS5 on FDC2          from step 4)</p>	<p>14          →</p>	<p>DUT should be able to receive Full duplex P-DPU on FDC0/TDS5.</p>
--	--------------------------	--

**Table A.7 — Test scenario 6**

Test Box with reference plate-electrode assembly	Step number and Direction	Device under test (DUT)
<p>&lt; FDC2/TDS1 : Association Request 1 &gt; Pre-amble/Sync = Pattern P, Attribute = 00, Sequence number = 00, Payload = (00)(00)(00)(00)</p> <p>&lt; FDC2/TDS5 : Association Response 1 &gt; Pre-amble/Sync = Pattern P, Attribute = 00, Sequence number = 01, Payload = (00)(00)(00)(00)</p> <p>&lt; FDC2/TDS2 : Association Request 1 &gt; Pre-amble/Sync = Pattern P, Attribute = 00, Sequence number = 00, Payload = (00)(00)(00)(00)</p> <p>&lt; FDC2/TDS6 : Association Response 1 &gt; Pre-amble/Sync = Pattern P, Attribute = 00, Sequence number = 01, Payload = (00)(00)(00)(00)</p> <p>&lt; FDC2/TDS3 : Association Request 1 &gt; Pre-amble/Sync = Pattern P, Attribute = 00, Sequence number = 00, Payload = (00)(00)(00)(00)</p> <p>&lt; FDC2/TDS7 : Association Response 1 &gt; Pre-amble/Sync = Pattern P, Attribute = 00, Sequence number = 01, Payload = (00)(00)(00)(00)</p> <p>&lt; FDC2/TDS4 : Association Request 1 &gt; Pre-amble/Sync = Pattern P, Attribute = 00, Sequence number = 00, Payload = (00)(00)(00)(00)</p> <p>&lt; FDC2/TDS8 : Association Response 1 &gt; Pre-amble/Sync = Pattern P, Attribute = 00, Sequence number = 01, Payload = (00)(00)(00)(00)</p> <p>(Test Box sends Association Request 1 or Association Response 1 on all TDSs on FDC2)</p>	<p>1 →</p>	<p>&lt; FDC2 : LBT &gt; DUT should be able to detect all occupied TDSs on FDC2.</p>
<p>&lt; FDC0/TDS1 : Broadcast &gt; Pre-amble/Sync = Pattern P, Attribute = 00, Sequence number = 00, Payload = (00)(00)(00)(00)</p> <p>&lt; FDC0/TDS2 : Broadcast &gt; Pre-amble/Sync = Pattern P, Attribute = 00, Sequence number = 00, Payload = (00)(00)(00)(00)</p> <p>&lt; FDC0/TDS3 : Broadcast &gt; Pre-amble/Sync = Pattern P, Attribute = 00, Sequence number = 00, Payload = (00)(00)(00)(00)</p> <p>&lt; FDC0/TDS4 : Broadcast &gt; Pre-amble/Sync = Pattern P, Attribute = 00, Sequence number = 00, Payload = (00)(00)(00)(00)</p> <p>&lt; FDC0/TDS5 : Broadcast &gt; Pre-amble/Sync = Pattern P, Attribute = 00, Sequence number = 01, Payload = (00)(00)(00)(00)</p> <p>&lt; FDC0/TDS6 : Broadcast &gt; Pre-amble/Sync = Pattern P, Attribute = 00, Sequence number = 01, Payload = (00)(00)(00)(00)</p> <p>&lt; FDC0/TDS7 : Broadcast &gt; Pre-amble/Sync = Pattern P, Attribute = 00, Sequence number = 01, Payload = (00)(00)(00)(00)</p> <p>&lt; FDC0/TDS8 : Broadcast &gt; Pre-amble/Sync = Pattern P, Attribute = 00, Sequence number = 01, Payload = (00)(00)(00)(00)</p> <p>(Test Box sends : Broadcast P-PDUs on all TDSs on FDC0)</p>	<p>2 →</p>	<p>&lt; FDC0 : LBT &gt; DUT should be able to detect all occupied TDSs on FDC0.</p>



**Table A.7 — Test scenario 6 (continued)**

<p>&lt; FDC2/TDS2 : Association Request 1 &gt; Pre-amble/Sync = Pattern P, Attribute = 00, Sequence number = 00, Payload = (00)(00)(00)(00)</p> <p>&lt; FDC2/TDS6 : Association Response 1 &gt; Pre-amble/Sync = Pattern P, Attribute = 00, Sequence number = 01, Payload = (00)(00)(00)(00)</p> <p>&lt; FDC2/TDS3 : Association Request 1 &gt; Pre-amble/Sync = Pattern P, Attribute = 00, Sequence number = 00, Payload = (00)(00)(00)(00)</p> <p>&lt; FDC2/TDS7 : Association Response 1 &gt; Pre-amble/Sync = Pattern P, Attribute = 00, Sequence number = 01, Payload = (00)(00)(00)(00)</p> <p>&lt; FDC2/TDS4 : Association Request 1 &gt; Pre-amble/Sync = Pattern P, Attribute = 00, Sequence number = 00, Payload = (00)(00)(00)(00)</p> <p>&lt; FDC2/TDS8 : Association Response 1 &gt; Pre-amble/Sync = Pattern P, Attribute = 00, Sequence number = 01, Payload = (00)(00)(00)(00)</p> <p>(Test Box sends Association Request 1 or Association Response 1 on TDSs except TDS1 and TDS5 on FDC2)</p>	<p>3 →</p>	<p>&lt; FDC2 : LBT &gt; DUT should be able to detect the vacant TDS1 and TDS5 on FDC2.</p>
<p>&lt; FDC0/TDS2 : Broadcast &gt; Pre-amble/Sync = Pattern P, Attribute = 00, Sequence number = 00, Payload = (00)(00)(00)(00)</p> <p>&lt; FDC0/TDS3 : Broadcast &gt; Pre-amble/Sync = Pattern P, Attribute = 00, Sequence number = 00, Payload = (00)(00)(00)(00)</p> <p>&lt; FDC0/TDS4 : Broadcast &gt; Pre-amble/Sync = Pattern P, Attribute = 00, Sequence number = 00, Payload = (00)(00)(00)(00)</p> <p>&lt; FDC0/TDS5 : Broadcast &gt; Pre-amble/Sync = Pattern P, Attribute = 00, Sequence number = 01, Payload = (00)(00)(00)(00)</p> <p>&lt; FDC0/TDS6 : Broadcast &gt; Pre-amble/Sync = Pattern P, Attribute = 00, Sequence number = 01, Payload = (00)(00)(00)(00)</p> <p>&lt; FDC0/TDS7 : Broadcast &gt; Pre-amble/Sync = Pattern P, Attribute = 00, Sequence number = 01, Payload = (00)(00)(00)(00)</p> <p>&lt; FDC0/TDS8 : Broadcast &gt; Pre-amble/Sync = Pattern P, Attribute = 00, Sequence number = 01, Payload = (00)(00)(00)(00)</p> <p>(Test Box sends : Broadcast P-PDU except TDS1 on FDC0)</p>	<p>4 →</p>	<p>&lt; FDC0 : LBT &gt; DUT should be able to detect the vacant TDS1 on FDC0.</p>
	<p>5 ←</p>	<p>&lt; FDC2/TDS1 : Association Request 1 &gt; Pre-amble/Sync = Pattern P, Attribute = 00, Sequence number = 00, Payload = (00)(02)(00)(FE)</p> <p>(Used FDC0, Talker uses TDS1, Listener uses TDS5, Full duplex)</p>

**Table A.7 — Test scenario 6 (continued)**

<p>&lt; FDC2/TDS5 : Association Response 1 &gt; Pre-amble/Sync = Pattern P, Attribute = 00, Sequence number = 01, Payload = (00)(00)(00)(00)</p> <p>&lt; FDC2/TDS2 : Association Request 1 &gt; Pre-amble/Sync = Pattern P, Attribute = 00, Sequence number = 00, Payload = (00)(00)(00)(00)</p> <p>&lt; FDC2/TDS6 : Association Response 1 &gt; Pre-amble/Sync = Pattern P, Attribute = 00, Sequence number = 01, Payload = (00)(00)(00)(00)</p> <p>&lt; FDC2/TDS3 : Association Request 1 &gt; Pre-amble/Sync = Pattern P, Attribute = 00, Sequence number = 00, Payload = (00)(00)(00)(00)</p> <p>&lt; FDC2/TDS7 : Association Response 1 &gt; Pre-amble/Sync = Pattern P, Attribute = 00, Sequence number = 01, Payload = (00)(00)(00)(00)</p> <p>&lt; FDC2/TDS4 : Association Request 1 &gt; Pre-amble/Sync = Pattern P, Attribute = 00, Sequence number = 00, Payload = (00)(00)(00)(00)</p> <p>&lt; FDC2/TDS8 : Association Response 1 &gt; Pre-amble/Sync = Pattern P, Attribute = 00, Sequence number = 01, Payload = (00)(00)(00)(00)</p> <p>(Test Box sends Association Response 1 on FDC2/TDS5 from step 4)</p>	<p>6 →</p>	<p>DUT should be able to receive Association Response 1.</p>
	<p>7 ←</p>	<p>&lt; FDC2/TDS1 : Association Request 2 &gt; Pre-amble/Sync = Pattern P, Attribute = 01, Sequence number = 10, Payload = (00)(00)(00)(00)</p>
<p>&lt; FDC2/TDS5 : Association Response 2 &gt; Pre-amble/Sync = Pattern P, Attribute = 01, Sequence number = 11, Payload = (00)(02)(00)(FE)</p> <p>&lt; FDC2/TDS2 : Association Request 1 &gt; Pre-amble/Sync = Pattern P, Attribute = 00, Sequence number = 00, Payload = (00)(00)(00)(00)</p> <p>&lt; FDC2/TDS6 : Association Response 1 &gt; Pre-amble/Sync = Pattern P, Attribute = 00, Sequence number = 01, Payload = (00)(00)(00)(00)</p> <p>&lt; FDC2/TDS3 : Association Request 1 &gt; Pre-amble/Sync = Pattern P, Attribute = 00, Sequence number = 00, Payload = (00)(00)(00)(00)</p> <p>&lt; FDC2/TDS7 : Association Response 1 &gt; Pre-amble/Sync = Pattern P, Attribute = 00, Sequence number = 01, Payload = (00)(00)(00)(00)</p> <p>&lt; FDC2/TDS4 : Association Request 1 &gt; Pre-amble/Sync = Pattern P, Attribute = 00, Sequence number = 00, Payload = (00)(00)(00)(00)</p> <p>&lt; FDC2/TDS8 : Association Response 1 &gt; Pre-amble/Sync = Pattern P, Attribute = 00, Sequence number = 01, Payload = (00)(00)(00)(00)</p> <p>(Test Box sends Association Response 2 on FDC2/TDS5 from step 4)</p>	<p>8 →</p>	<p>DUT should be able to receive Association Response 2.</p>
<p>(Test Box sends same P-PDUs and checks to receive the P-PDU from DUT with iteration count)</p>	<p>9 ←</p>	<p>&lt; FDC0/TDS1 : Broadcast &gt; Pre-amble/Sync = Pattern P, Attribute = 10, Sequence number = 00, Payload = (0A)(00)(55)(AA) ● Check iteration count function</p> <p>(DUT sends the first P-DU segment iteration count times)</p>

**Table A.7 — Test scenario 6 (concluded)**

(Test Box sends same P-PDUs and checks to receive the P-PDU from DUT with iteration count)	10 ←	<p>&lt; FDC0/TDS1 : Broadcast &gt;            Pre-amble/Sync = Pattern P, Attribute = 11,            Sequence number = 01, Payload = (00)(FF)(C3)(E7)</p> <ul style="list-style-type: none"> <li>● Check iteration count function</li> </ul>
(Test Box sends same P-PDUs and checks to receive the P-PDU from DUT with iteration count)	11 ←	<p>&lt; FDC0/TDS1 : Broadcast &gt;            Pre-amble/Sync = Pattern P, Attribute = 01,            Sequence number = 10, Payload = (96)(42)(B0)(4A)</p> <ul style="list-style-type: none"> <li>● Check iteration count function</li> </ul>

**Table A.8 — Test scenario 7**

Test Box with reference plate-electrode assembly	Step number and Direction	Device under test (DUT)
<p>&lt; FDC1/TDS2 : Full duplex &gt; Pre-amble/Sync = Pattern P, Attribute = 00, Sequence number = 00, Payload = (00)(00)(00)(00)</p> <p>&lt; FDC1/TDS6 : Full duplex &gt; Pre-amble/Sync = Pattern P, Attribute = 00, Sequence number = 01, Payload = (00)(00)(00)(00)</p> <p>&lt; FDC1/TDS3 : Full duplex &gt; Pre-amble/Sync = Pattern P, Attribute = 00, Sequence number = 00, Payload = (00)(00)(00)(00)</p> <p>&lt; FDC1/TDS7 : Full duplex &gt; Pre-amble/Sync = Pattern P, Attribute = 00, Sequence number = 01, Payload = (00)(00)(00)(00)</p> <p>&lt; FDC1/TDS4 : Full duplex &gt; Pre-amble/Sync = Pattern P, Attribute = 00, Sequence number = 00, Payload = (00)(00)(00)(00)</p> <p>&lt; FDC1/TDS8 : Full duplex &gt; Pre-amble/Sync = Pattern P, Attribute = 00, Sequence number = 01, Payload = (00)(00)(00)(00)</p> <p>(Test Box sends Full duplex P-PDUs on TDSs except TDS1 and TDS5 on FDC0)</p>	<p>1 →</p>	
	<p>2 ←</p>	<p>&lt; FDC1/TDS1 : Full duplex &gt; Pre-amble/Sync = Pattern P, Attribute = 10, Sequence number = 00, Payload = (0A)(00)(55)(AA)</p> <p>(DUT sends the first P-DU segment)</p>
<p>&lt; FDC1/TDS5 : Full duplex &gt; Pre-amble/Sync = Pattern P, Attribute = 00, Sequence number = 01, Payload = (0A)(00)(55)(AA)</p> <p>&lt; FDC1/TDS2 : Full duplex &gt; Pre-amble/Sync = Pattern P, Attribute = 00, Sequence number = 00, Payload = (00)(00)(00)(00)</p> <p>&lt; FDC1/TDS6 : Full duplex &gt; Pre-amble/Sync = Pattern P, Attribute = 00, Sequence number = 01, Payload = (00)(00)(00)(00)</p> <p>&lt; FDC1/TDS3 : Full duplex &gt; Pre-amble/Sync = Pattern P, Attribute = 00, Sequence number = 00, Payload = (00)(00)(00)(00)</p> <p>&lt; FDC1/TDS7 : Full duplex &gt; Pre-amble/Sync = Pattern P, Attribute = 00, Sequence number = 01, Payload = (00)(00)(00)(00)</p> <p>&lt; FDC1/TDS4 : Full duplex &gt; Pre-amble/Sync = Pattern P, Attribute = 00, Sequence number = 00, Payload = (00)(00)(00)(00)</p> <p>&lt; FDC1/TDS8 : Full duplex &gt; Pre-amble/Sync = Pattern P, Attribute = 00, Sequence number = 01, Payload = (00)(00)(00)(00)</p> <p>(Test Box sends Full duplex P-PDU on TDS5 on FDC2 from step 4)</p>	<p>3 →</p>	<p>DUT should be able to receive Full duplex P-DPU on FDC1/TDS5.</p>
	<p>4 ←</p>	<p>&lt; FDC1/TDS1 Full duplex &gt; Pre-amble/Sync = Pattern P, Attribute = 11, Sequence number = 10, Payload = (00)(FF)(C3)(E7)</p> <p>(DUT sends the between P-DU segment)</p>

**Table A.8 — Test scenario 7 (concluded)**

<p>&lt; FDC1/TDS5 : Full duplex &gt; Pre-amble/Sync = Pattern P, Attribute = 11, Sequence number = 11, Payload = (00)(FF)(C3)(E7)</p> <p>&lt; FDC1/TDS2 : Full duplex &gt; Pre-amble/Sync = Pattern P, Attribute = 00, Sequence number = 00, Payload = (00)(00)(00)(00)</p> <p>&lt; FDC1/TDS6 : Full duplex &gt; Pre-amble/Sync = Pattern P, Attribute = 00, Sequence number = 01, Payload = (00)(00)(00)(00)</p> <p>&lt; FDC1/TDS3 : Full duplex &gt; Pre-amble/Sync = Pattern P, Attribute = 00, Sequence number = 00, Payload = (00)(00)(00)(00)</p> <p>&lt; FDC1/TDS7 : Full duplex &gt; Pre-amble/Sync = Pattern P, Attribute = 00, Sequence number = 01, Payload = (00)(00)(00)(00)</p> <p>&lt; FDC1/TDS4 : Full duplex &gt; Pre-amble/Sync = Pattern P, Attribute = 00, Sequence number = 00, Payload = (00)(00)(00)(00)</p> <p>&lt; FDC1/TDS8 : Full duplex &gt; Pre-amble/Sync = Pattern P, Attribute = 00, Sequence number = 01, Payload = (00)(00)(00)(00)</p> <p>(Test Box sends Full duplex P-PDU on TDS5 on FDC2 from step 4)</p>	<p>5 →</p>	<p>DUT should be able to receive Full duplex P-DPU on FDC1/TDS5.</p>
	<p>6 ←</p>	<p>&lt; FDC1/TDS1 : Full duplex &gt; Pre-amble/Sync = Pattern P, Attribute = 01, Sequence number = 00, Payload = (96)(42)(B0)(4A)</p> <p>(DUT sends the last P-DU segment)</p>
<p>&lt; FDC1/TDS5 : Full duplex &gt; Pre-amble/Sync = Pattern P, Attribute = 01, Sequence number = 01, Payload = (96)(42)(B0)(4A)</p> <p>&lt; FDC1/TDS2 : Full duplex &gt; Pre-amble/Sync = Pattern P, Attribute = 00, Sequence number = 00, Payload = (00)(00)(00)(00)</p> <p>&lt; FDC1/TDS6 : Full duplex &gt; Pre-amble/Sync = Pattern P, Attribute = 00, Sequence number = 01, Payload = (00)(00)(00)(00)</p> <p>&lt; FDC1/TDS3 : Full duplex &gt; Pre-amble/Sync = Pattern P, Attribute = 00, Sequence number = 00, Payload = (00)(00)(00)(00)</p> <p>&lt; FDC1/TDS7 : Full duplex &gt; Pre-amble/Sync = Pattern P, Attribute = 00, Sequence number = 01, Payload = (00)(00)(00)(00)</p> <p>&lt; FDC1/TDS4 : Full duplex &gt; Pre-amble/Sync = Pattern P, Attribute = 00, Sequence number = 00, Payload = (00)(00)(00)(00)</p> <p>&lt; FDC1/TDS8 : Full duplex &gt; Pre-amble/Sync = Pattern P, Attribute = 00, Sequence number = 01, Payload = (00)(00)(00)(00)</p> <p>(Test Box sends Full duplex P-PDU on TDS5 on FDC2 from step 4)</p>	<p>7 →</p>	<p>DUT should be able to receive Full duplex P-DPU on FDC1/TDS5.</p>

**Table A.9 — Test scenario 8**

<b>Test Box with reference plate-electrode assembly</b>	<b>Step number and Direction</b>	<b>Device under test (DUT)</b>
(DUT sends same P-PDUs and Test Box checks to receive the P-PDU from DUT with iteration count)	1 ←	< FDC1/TDS1 : Broadcast > Pre-amble/Sync = Pattern P, Attribute = 10, Sequence number = 00, Payload = (0A)(00)(55)(AA) ● Check iteration count function  (DUT sends the first P-DU segment iteration count times)
(DUT sends same P-PDUs and Test Box checks to receive the P-PDU from DUT with iteration count)	2 ←	< FDC1/TDS1 : Broadcast > Pre-amble/Sync = Pattern P, Attribute = 11, Sequence number = 01, Payload = (00)(FF)(C3)(E7) ● Check iteration count function  (DUT sends the between P-DU segment iteration count times)
(DUT sends same P-PDUs and Test Box checks to receive the P-PDU from DUT with iteration count)	3 ←	< FDC1/TDS1 : Broadcast > Pre-amble/Sync = Pattern P, Attribute = 01, Sequence number = 10, Payload = (96)(42)(B0)(4A) ● Check iteration count function  (DUT sends the last P-DU segment iteration count times)



